

SCS
NATIONAL
ENGINEERING
HANDBOOK

SECTION 16

DRAINAGE OF AGRICULTURAL LAND

U. S. DEPARTMENT OF AGRICULTURE
SOIL CONSERVATION SERVICE



UNITED STATES DEPARTMENT OF AGRICULTURE

SOIL CONSERVATION SERVICE

NATIONAL ENGINEERING HANDBOOK

SECTION 16

DRAINAGE OF AGRICULTURAL LAND

UNITED STATES DEPARTMENT OF AGRICULTURE

SOIL CONSERVATION SERVICE

NATIONAL ENGINEERING HANDBOOK

SECTION 16

DRAINAGE OF AGRICULTURAL LAND

PREFACE

This section of the National Engineering Handbook of the Soil Conservation Service has been developed as a guide for investigations, surveys, design, construction, and maintenance of facilities for agricultural drainage. It is intended primarily as a working handbook, and very little theory is included. References are given to research data and theoretical analyses where it is felt the user may wish additional information on a particular procedure or criteria.

The handbook is developed for use in all fifty states and the Carribean Area, so it is necessarily rather general in many respects. For use in a specific area it should be supplemented with data on soils, climate, topography, and land use data applicable to the area.

The Engineering Field Manual for Conservation Practices, USDA-SCS, includes a chapter on drainage which has some of the same information included in this handbook. It is developed primarily for work unit operations, and covers the drainage work performed in the work unit in more specific detail than does this section of the National Engineering Handbook.

In addition to the handbook and field manual, drainage standards and guides should be available in each state, area, and work unit where drainage of wet land is a needed practice. The drainage guide is the accumulative record of experiences of drainage engineers and other technicians in planning, installing, and evaluating the effectiveness of drainage systems. It provides a local guide for such criteria as depth and spacing of ditches and drains, drainage coefficients, and other standards based on soils, climate, topography, and land use. Drainage guides should supplement and be consistent with SCS standards developed at the National and state levels. The number of drainage guides needed in each state will depend on variations in drainage problems. A guide may cover an entire state, problem area, or work unit area.

Personnel working on planning and design of drainage improvements also should have access to textbooks, hydraulic handbooks and tables, hydrologic records, bulletins, and other data of value in planning and design of drainage works. The Corps of Engineers' Hydraulic Tables is especially helpful in channel design. King and Brater's Handbook of Hydraulics is used in the solution of many drainage design problems.

This section of the National Engineering Handbook has been developed over a period of sixteen years. Tentative drafts of two chapters were issued in September 1955. Most of the chapters have been revised many times since the first draft, and many of them have been in field use for several years. A large number of Soil Conservation Service employees have contributed to the development of the handbook by their review and suggestions.

Credit for the inception of the project and guidance in its growth through most of the development period is due to the late John G. Sutton. His knowledge of agricultural drainage and experience in drainage operations were invaluable in developing this handbook.

In addition to John Sutton, the following SCS drainage engineers have been the principal contributors to the project:

Ralph H. Brownscombe, Washington, D. C.
Guy B. Fasken, Lincoln, Nebraska
Hawthorne J. Foreman, Fort Worth, Texas
Elmer W. Gain, Upper Darby, Pennsylvania
Louis W. Herndon, Washington, D. C.
William F. Long, Portland, Oregon
Edo A. Schlaudt, Spartanburg, South Carolina

Significant contributions also were made by George B. Bradshaw, formerly Drainage Engineer, Portland, Oregon, Richard J. Patronskey, Drainage Engineer, Lincoln, Nebraska and Charles M. Stokes, formerly Drainage Engineer, Albuquerque, New Mexico.

All of the work was done under the general direction of Chester J. Francis, Director of the Engineering Division, Soil Conservation Service, Washington, D. C.

Engineering Division
Soil Conservation Service
U. S. Department of Agriculture
Washington, D. C. 20250

May 1971

UNITED STATES DEPARTMENT OF AGRICULTURE

SOIL CONSERVATION SERVICE

NATIONAL ENGINEERING HANDBOOK

SECTION 16

DRAINAGE OF AGRICULTURAL LAND

CONTENTS

| | <u>Page</u> |
|---|-------------|
| INTRODUCTION | |
| Definition of Agricultural Drainage | 1 |
| Drainage in the United States | 1 |
| Drainage in the Soil and Water Conservation Program | 2 |
| Drainage Enterprises | 2 |
| Drainage System Terms | 8 |
| References | 12 |
| CHAPTER 1. PRINCIPLES OF DRAINAGE | |
| Scope | 1-1 |
| Elements of Drainage Design | 1-1 |
| Types of Drainage Problems | 1-3 |
| Differences in Drainage in Humid and Arid Areas | 1-6 |
| Crop Requirements | 1-7 |
| Surface-Drainage Principles | 1-8 |
| Subsurface-Drainage Principles | 1-9 |
| Theories of Buried Drain and Open Ditch Subsurface Drainage | 1-19 |
| Design Criteria | 1-23 |
| Pumped-Well Drainage | 1-25 |
| References | 1-29 |
| CHAPTER 2. DRAINAGE INVESTIGATIONS | |
| General | 2-1 |
| Classification of Investigations | 2-5 |
| Reconnaissance | 2-5 |
| Preliminary Survey | 2-8 |
| Design Survey | 2-11 |
| Investigations for Surface Drainage | 2-13 |
| Investigations for Subsurface Drainage | 2-18 |
| References | 2-47 |
| Appendix - Typical Outline for Preliminary Survey | 2A-1 |
| CHAPTER 3. SURFACE DRAINAGE | |
| General | 3-1 |
| Surface Drainage Systems | 3-3 |
| Types and Functions of Surface-Drainage Ditches | 3-12 |

| | <u>Page</u> |
|---|-------------|
| Land Forming | 3-13 |
| Joint Surface and Subsurface Drainage System | 3-18 |
| References | 3-22 |
| CHAPTER 4. SUBSURFACE DRAINAGE | |
| Introduction | 4-1 |
| General | 4-1 |
| Diagnosis and Improvement of Saline and Alkali Soils | 4-3 |
| Planning Subsurface Drainage | 4-11 |
| Design of Subsurface Drains | 4-43 |
| Installation Design | 4-77 |
| Construction | 4-106 |
| Maintenance of Buried Drains | 4-119 |
| References | 4-122 |
| CHAPTER 5. OPEN DITCHES FOR DRAINAGE - DESIGN, CONSTRUCTION AND MAINTENANCE | |
| General | 5-1 |
| Location | 5-1 |
| Required Capacities | 5-4 |
| Design Standards | 5-18 |
| Design Procedure | 5-21 |
| Auxiliary Structures and Practices | 5-39 |
| Construction Plans | 5-44 |
| Maintenance of Open Ditches | 5-48 |
| References | 5-52 |
| CHAPTER 6. DIKES | |
| Classification of Dikes | 6-1 |
| Investigations for Dikes | 6-3 |
| Design of Dikes | 6-5 |
| Construction | 6-12 |
| Maintenance | 6-14 |
| References | 6-15 |
| CHAPTER 7. DRAINAGE PUMPING | |
| Scope | 7-1 |
| Nomenclature and Definitions | 7-2 |
| Need for Pumping | 7-5 |
| Location of the Pumping Plant | 7-5 |
| Incorporating the Pumping Plant in the Drainage System | 7-6 |
| Static Lift | 7-7 |
| Pumping Plant Capacity | 7-9 |
| Pumping Plant Design | 7-13 |
| Field Tests of Drainage Pumping Plants | 7-48 |
| Operation and Maintenance | 7-53 |
| References | 7-54 |
| Appendix A - Determining Pumping Plant Capacity Based on Hydrologic and Economic Factors | 7A-1 |
| Appendix B - Design of Farm Drainage Pumping Plant | 7B-1 |

Page

CHAPTER 8. DRAINAGE OF ORGANIC SOILS

| | |
|--|-----|
| General | 8-1 |
| Classification of Organic Soils | 8-1 |
| Subsidence in Drained Organic Soils | 8-3 |
| Other Characteristics of Organic Soils and Their Treatment | 8-4 |
| Design Requirements for Ditches and Drains | 8-5 |
| Pump Drainage | 8-6 |
| Dikes | 8-6 |
| Controlled Drainage | 8-7 |
| References | 8-8 |

CHAPTER 9. DRAINAGE OF TIDAL LANDS

| | |
|----------------------------------|------|
| General | 9-1 |
| Determination of Local Tide Data | 9-6 |
| Site Investigations and Surveys | 9-7 |
| Design Data | 9-9 |
| Design Procedure and Example | 9-11 |
| Supplemental Pumping | 9-19 |
| Construction and Installation | 9-24 |
| References | 9-29 |

UNITED STATES DEPARTMENT OF AGRICULTURE

SOIL CONSERVATION SERVICE

NATIONAL ENGINEERING HANDBOOK

SECTION 16

DRAINAGE OF AGRICULTURAL LAND

INTRODUCTION

Definition of Agricultural Drainage

Agricultural drainage may be defined as the removal and disposal of excess water from agricultural land.

The sources of excess water may be precipitation, snowmelt, irrigation water, overland flow or underground seepage from adjacent areas, artesian flow from deep aquifers, floodwater from channels, or water applied for such special purposes as leaching salts from the soil or for temperature control.

Drainage systems are needed to supplement natural drainage in many areas. The amount of water to be removed by such systems depends, therefore, upon the relative effectiveness of the natural and the constructed drainage.

Agricultural drainage is divided into two broad classes: surface and subsurface. Some installations serve the dual purposes of surface and subsurface drainage.

Drainage in the United States

Drainage has made agricultural development possible on much of the most productive land in the United States. The 1959 Census of Agriculture shows that nearly 102 million acres in 39 states are contained in more than 8400 drainage enterprises with areas over 500 acres in size. Within these enterprises, drainage improvements have been made on about 92 million acres. It is estimated that about 39 million acres not covered in the census have been drained by individual landowners and in small group enterprises less than 500 acres in size (1).* Now approximately 130 million acres or about one-third of all cropland is drained artificially.

According to statistics compiled by the International Commission on Irrigation and Drainage for its 1965 Annual Bulletin, the area protected by drainage works in the United States is 40 million hectares (98.8 million acres) not including irrigated areas (2). This is slightly more than one-half of the total drainage (not including irrigated areas) reported by the 59 nations included in the tabulation. Data for China is not included.

As the basis for reporting data for the ICID survey is not the same as for the census, the figures given are not comparable, but when drained areas in irrigation projects and in small drainage projects (less than 500 acres in size) are included, the data reported compares favorably with the 130 million acres given above as the total area of agricultural drainage in the United States.

*Numbers in parentheses refer to references listed on page 12.

Drainage on an individual farm is and always has been the responsibility of the landowner. Needed drainage works beyond the farm are usually obtained by landowners cooperating under state law or under an informal group arrangement. A state agency may provide drainage facilities when the need for drainage is widespread over the state. This is done under cooperative arrangements with the local political subdivision.

Federal government participation in drainage until the mid 1930's had been limited to minor research and technical assistance. Today federal assistance is provided as an integral part of a comprehensive land and water development program through individual projects of the Departments of Agriculture, Army, and Interior. Earlier drainage works, with some exceptions, were established under conditions of a pioneering agriculture by landowners and local artisans, largely piecemeal, on a trial-and-error basis, and along general principles handed down from generation to generation.

Current new facilities, and the improvement of old facilities, are now planned and installed on the basis of engineering designs applied to a coordinated system of surface and subsurface ditches and drains discharging in an adequate outlet; and whatever protecting dikes, diversion channels, gates and pumps may be required by site conditions for protection against overflow. Designs incorporate the latest knowledge and techniques of hydrology, hydraulics, geology and the soil sciences. Construction materials, methods and equipment are used to provide the most efficient and economical installations applicable to the sites. Design and construction are being modified and improved by continuing research findings of industry, state and federal governments.

Drainage in the Soil and Water Conservation Program

Soil Conservation Service assistance for drainage measures is provided primarily for increasing the efficiency of land use while conserving our land resource on farms and ranches. This is done by improving existing drainage systems or by constructing new systems.

Drainage permits better timing of seasonal cultivation, lowers the cost of cultivation, and improves seed germination. Drainage also may permit adjustment in land use on a farm or ranch, so the steeper land subject to erosion may be used for hay or pasture, and the flatter, drained land for cultivated crops.

In many irrigated areas of the West, the water table rises and causes increasing damage to land and crops. Harmful salts may accumulate and saline or alkaline conditions may develop where the water table is near the surface.

Drainage is a first step in the improvement of much of our wet land before other needed conservation practices can be applied successfully.

Drainage Enterprises

To assure adequate disposal of excess water from all parts of drainage systems, there must be uninterrupted flow from the point where the water starts through the disposal system to an adequate outlet. The outlet must be capable of handling the flow without it causing damages above or below the point of discharge. Improvements frequently are needed to a channel, beyond the point where the drainage system discharges, to obtain required capacity and to prevent flooding.

Frequently a channel providing the outlet for a drainage system, or systems, must be improved through land under several ownerships. In such cases it is necessary for the landowners to work together to accomplish their objective--improved drainage. Some type of organization of the landowners is usually needed.

Group organization for drainage improvement may be desirable for any one or all of the following reasons:

1. To obtain an adequate outlet for drainage from all lands in which the group is interested, and to permit coordinated planning.
2. To provide an organization to obtain the necessary financing, and the means for equitably distributing the costs of planning, constructing, and maintaining the needed improvements among all the benefited owners.
3. To provide the organization and leadership required to plan, construct, and maintain the needed improvements.
4. To obtain necessary rights-of-way for construction and maintenance operations.

Types of enterprises

State laws for forming drainage enterprises vary considerably, and the terminology in them is different in the several states. It is necessary for personnel engaged in drainage work to become familiar with applicable drainage laws and procedures for forming drainage enterprises. For the discussion here the following terms and their definitions will be used.

1. Drainage enterprise--a project, by an organization or a group, to make drainage improvements within certain defined boundaries. All of the following types of organizations are included:
 2. Legal organization--an organization established in accordance with state laws to provide the means to carry on drainage work on lands within certain boundaries. Such legal organization has the power to tax and to condemn land for rights-of-way. Legal organizations include drainage districts, water control and improvement districts, levee districts, conservation and reclamation districts, and agencies for county and township ditches and drains. The term "drainage district," as used here, denotes any legal organization as already described.
 3. Voluntary or cooperative groups--an unincorporated drainage enterprise where the entire membership is voluntary. There are two types:
 - a. Drainage association--a formal organization of landowners or operators to do drainage work within a certain defined area--without the powers of taxation or condemnation, but with contractual and purchasing powers.
 - b. Informal drainage group--a group of two or more landowners or operators, who have mutually agreed to work together on drainage improvements within a certain defined area without the powers of taxation or condemnation.

Characteristics of enterprises

The differences in the types of organization for drainage enterprises are in the degree of organization and in the powers they have. Generally the informal group will be adequate for small enterprises. As the enterprise increases in size and number of landowners or operators, the organization to handle financing, procurement of easements, construction and maintenance needs to have its powers increased and its responsibilities clarified. Various factors enter into selecting the best type of organization. To furnish the best advice, the engineer should know the characteristics of each type.

Drainage districts

Laws governing drainage districts vary between states. They are specific, however, and must be followed exactly. A digest of the laws pertaining to drainage and drainage districts currently applicable in the state is a valuable working tool. In most states drainage districts have the following advantageous characteristics:

1. They can handle all kinds of drainage work.
2. A group of commissioners is elected or appointed. These commissioners have authority to operate and maintain the district.
3. Drainage districts are provided with means for financing large enterprises. They have the power to tax and usually they may sell bonds on approval of the landowners in the district or the court. Taxes may be levied to finance new construction or to improve or maintain existing works.
4. Districts have the authority to acquire rights-of-way for drainage work. This includes the power of condemnation.
5. Drainage districts can hire employees and purchase equipment and supplies to carry on drainage activities.

Some disadvantages of drainage districts for handling drainage work which could be handled by drainage associations are:

1. Often several months are required to organize.
2. Many drainage districts have high overhead costs.

Certain drainage districts organized in the past have experienced financial difficulties and have failed to maintain their improvements. Hence, in many areas, landowners and operators are reluctant to organize even though some type of legal organization to obtain rights-of-way, to equitably finance the work and to maintain works of improvement is essential where sizeable group drainage facilities are needed.

Drainage associations

These associations have been most successful where they did not include too large a working group, usually of not more than 15 members. The association is unincorporated and voluntary for all members. It operates under articles of association and elected officers.

Unless restricted by state laws concerning the size of groups which may organize associations, the drainage association may be given official status

by the recording of the articles of association in the office of the county or parish clerk. If the number of farmers is insufficient to meet requirements for such organization under state law, the association may be formed as outlined but the recording of the articles of association with the county clerk would not be possible.

Advantages of drainage associations are:

1. The organization is simple and may be accomplished quickly.
2. An elected official is available to do business for the association.
3. An organization is provided to carry out continued maintenance.
4. Means are provided to distribute costs, collect money (through voluntary subscription only), and make contracts.

Some disadvantages are:

1. There are no provisions for taxation or condemnation for rights-of-way. Rights-of-way may be obtained through negotiation only.
2. Death or serious injury to an association employee may impose a large financial liability. If the association hires employees, it should obtain compensation insurance for such contingencies.

Informal groups

Small groups, usually less than half-a-dozen farmers, are held together only through agreement and are financed by voluntary contribution.

There is no formal organization. In dealing with the group it is necessary to get the members together, or carry the proposition to each member separately, unless a member has been duly elected by the group as their leader.

Advantages of the informal group are:

1. Simplicity of formation--no organization is necessary. The group is formed merely by each member signing a group agreement.

Disadvantages of the informal group are:

1. Working with an unorganized group is often difficult, especially as it concerns financing of unforeseeable things.
2. No organization is available to carry out future maintenance.
3. Acquisition of rights-of-way is often a problem since they can be obtained only through voluntary agreement.

Procedure for enterprises

General

All drainage jobs have certain similarities, and all enterprises must pass through certain stages of development. As the size and complexity of the job increases, the steps of development need to be more detailed and more clearly defined. The larger and more complex jobs will require more elaborate

engineering treatment. All enterprises require an engineering appraisal of the problem, presenting this appraisal to the owners, obtaining a decision of the owners as to course of action, making more detailed engineering surveys, preparing plans, and supervision of construction.

Some drainage enterprises, from a technical viewpoint, could be handled by either a drainage association or a drainage district. Others could be worked by an informal group or a drainage association. To determine which method is preferable for specific conditions, the procedure for development will be discussed for the three types of enterprises concurrently. In using the following information the policies of the Soil Conservation Service and the laws of the state should be followed closely.

Soil Conservation Service assistance to groups prior to organization

Assistance of SCS to a group enterprise provided in accordance with SCS policies, as covered in other communications, may take many forms. It may consist of advice as to courses of action and assistance with conservation planning; or it may consist of a complete engineering job for the improvements, and assistance with conservation planning. The guide for this assistance is contained in current policy statements of the Administrator. The form of the request from the group to the soil conservation district for assistance will be much the same as that for any request. For unorganized groups, signatures of at least two-thirds of the membership should be obtained.

Reconnaissance. - If the group of landowners has retained an engineer, he should be present during a reconnaissance of the proposed project, preliminary survey, meetings of the group, design surveys, planning works of improvement, and construction. After receiving an approved request for assistance, a reconnaissance of the project should be made for use in making recommendations to the group as to the feasibility of the project and the best type of organization. Chapter 2 of this handbook contains information on making the reconnaissance.

Preliminary information. - After the reconnaissance has been made the engineer should report to the group on his findings. He should make this report to the group and not to individuals. The report should be written, but is probably more effective if presented orally. The following points should be covered:

1. The areas within the limits of the proposed enterprise which need drainage.
2. Condition and adequacy of channels below the outlet to receive drainage runoff.
3. Flood, siltation, and erosion hazards.
4. Land capabilities.
5. Other drainage programs which may affect the enterprise.
6. Drainage facilities needed.
7. Discussion of costs and benefits. (This will be very general and based on experience with other drainage programs on the same type of land.)

8. Maintenance required and its probable annual cost.
9. Opinion as to physical and economic feasibility.
10. Recommendation as to type of organization needed to accomplish the job.

Completion of plans for organization. - Following the Service's report on the reconnaissance of the project, the group will have questions and will need to have free discussion of all aspects of the job. Perhaps a lawyer will need to be consulted. It may be necessary for the engineer to examine an alternate proposal. The group should obtain all the information it needs to make a decision or to determine its course of action. The SCS representative should make sure that members of the group understand their responsibilities.

Organization of enterprises

Legal enterprises. - The steps in the organization of a drainage district are prescribed by law and vary between states. Usually the reconnaissance provides sufficient engineering information on which to base a recommendation for the organization. The engineer should study the laws in his state to make sure all essential information is obtained and requirements of timing are complied with.

Drainage associations. - A drainage association can be organized simply by a vote of the members to adopt some simple articles of association. This may be accomplished at the meeting where the report on the reconnaissance by the engineer is presented.

Informal groups. - The formation of informal groups should follow the same procedure as that in the organization of a drainage association. The only differences would be to eliminate the adoption of articles of association and formal election of officers. If the group deemed it desirable, a leader could be elected to represent the group.

Operations after organization

The procedure to be followed after the organization of a legal enterprise is prescribed by law and must be followed.

Further contacts between SCS and the drainage association should be made with the man designated by the association, usually the president.

In the informal group it will be necessary to continue working with all the members of the group. Care should be taken to avoid working with only one individual in an informal group unless he is the designated leader for the group.

Ordinarily after the drainage enterprise is organized, more specific information is needed for further planning. The Soil Conservation Service probably will be called on to provide information similar to that developed in a preliminary survey--see Chapter 2. For very small groups this may be abbreviated but for the larger drainage associations and legal enterprises a full survey and report ordinarily will be justified. Progress reports at critical stages may be advisable so the group can make timely decisions.

The report should be presented orally to the full group. This will set the stage for discussion, decisions on proposed alterations in the plan, time schedules for further action, and financing arrangements.

Further work with a drainage association on design, construction, and maintenance can be handled with the person who has been designated by the association to handle its affairs.

Work with an informal group will need to be taken care of with the group as a whole.

Maintenance of the facility

One of the principal reasons for forming drainage enterprises is to provide for future maintenance of the drainage facilities.

A drainage district is ordinarily better qualified to handle maintenance than the drainage association or informal group. This is because it is a continuing organization and it has the authority to levy taxes for maintenance purposes.

Regardless of the size of the drainage system or type of organization, provisions for maintenance must be made to insure success of the enterprise. The maintenance program should be discussed during the organizational meetings and methods decided on. The design of the system will be based on methods of maintenance to be used.

A maintenance manual should be developed for the enterprise. The manual should describe the items of maintenance likely to be needed, how the maintenance will be accomplished and assign responsibilities. Dates should be set for maintenance inspections of the drainage system at least once each year. Personnel to assist in the inspections should be specified.

Individual farm drainage

Benefits from group enterprises do not accrue to the farmers involved until they have taken advantage of their newly constructed group facilities by draining their land into them. They should be encouraged to install their on-farm ditches and drains as soon as possible after the group facilities are constructed. This is necessary for success of the enterprise.

Drainage System Terms

The following terms, which apply to drainage systems and their various parts, are defined to provide Service personnel with a uniform understanding of their meaning as used in engineering standards and handbooks.

Reporting

This list includes drainage terms which are listed as SCS progress reporting items, but there is a breakdown of some of the reportable items into two or more items. For example, all of the following would be reported as Code 480 - Drainage Main or Lateral:

Stream - when improved as a part of a drainage system by construction to a designed size and grade.

Ditch -

Main Ditch -

Lateral, sublateral, farm lateral, field lateral -

The following would be reported as Code 606 - Drain:

Main Drain -
 Submain Drain -
 Relief Drain -
 Interceptor Drain -

Definitions

Surface drainage

The removal of excess water from the soil surface.

Subsurface drainage

The removal of excess water from below the soil surface.

Stream

A natural waterway. Includes small rivers, creeks, bayous, arroyos, runs, etc., which form part of a drainage system. Improvements may be required but location remains essentially unchanged. Streams should be identified by name or number.

Ditch

An open waterway excavated in the earth to collect and/or convey drainage water. A ditch may carry flow from both surface and subsurface drainage.

Channel

That part of a stream or ditch where the flow of water is carried.

Drain

A conduit, such as tile, pipe, or tubing, installed beneath the ground surface and which collects and/or conveys drainage water.

The outlet

The terminal point of the drainage system, ditch, or drain under consideration.

Vertical drain

A well, pipe, pit, or bore into porous, underground, strata into which drainage water can be discharged. This is also called a drainage well.

Evaporation pond

A pond, with impervious bottom, for storage and evaporation of low quality drainage effluent.

The disposal system

That part of a drainage system which receives water from the collection system and conveys it to an outlet.

Main ditch. - The principal ditch--improved or constructed--serving one or more drainage systems. Main ditches should be identified by name or number.

Lateral. - A major ditch in a drainage system, identified by name or number. A lateral is the link between the main ditch and sublaterals or farm laterals.

Sublateral. - An important branch ditch, tributary to a lateral, and identified by name or number. When needed, it is the link between a lateral and farm laterals.

Farm lateral. - A principal drainage ditch serving only one farm or a major portion of one farm. It is the link between field laterals and the ditch which usually serves a group of farms.

Field lateral. - The disposal ditch serving those fields adjacent to it on one farm. It is the link between the farm lateral and the collection system.

Main drain. - The principal subsurface drain which conducts drainage water from collection drains (see "The Collection System" below) and submain drains to the outlet. The drainage water may be excess surface water collected through surface inlets by the tributary drains and the main drain; or excess ground water collected by subsurface flow into the tributary drains and the main drain.

Submain drain. - A branch drain off the main drain into which collection drains or surface inlets flow.

The collection system - surface drainage

That part of a drainage system which collects excess surface water.

Field ditch. - A graded ditch for collecting excess water within a field. Water may enter it through crop rows or row ditches or by sheet flow over field surfaces.

Furrow. - Crop furrows are small channels developed in the preparation of cropland or in cultivating the crop.

Row ditch. - A small plow or shovel ditch cut each crop season across crop rows at low places to collect water and carry it into a field ditch or field lateral. These are often called annual, quarter, header ditches, etc.

The collection system - subsurface drainage

A system of ditches or drains located to collect excess ground water.

Relief ditch or drain. - A ditch or drain located at the depth and spacing required for control of the water table where the principal source of ground water is from the overlying land and the water table is relatively flat. These are usually drains.

Interceptor ditch or drain. - A ditch or drain located across the flow of ground water and installed to intercept subsurface flow.

Relief well. - A shallow well, which carries water under hydrostatic pressure, upward from a subsurface layer into a ditch or drain.

Pumped well drain. - A well sunk into an aquifer from which water is pumped to lower the prevailing water table.

Mole drain. - An underground conduit formed by pulling a bullet-shaped cylinder through the soil. A mole drain may discharge into either a ditch or drain.

Land forming

The process of changing the surface of the land to facilitate the movement of surface water over a field or a part of a field.

Land grading. - The shaping of the land surface by cutting, filling, and smoothing to planned grades. The primary purpose is to improve land drainage by establishing continuous grades so that runoff will flow over the surface without ponding. In some locations, this practice is called precision grading or land shaping.

Rough grading. - The shaping of the land surface according to judgment "by eye" or by limited use of engineering surveys. This operation may be the first step in land grading.

Land smoothing. - Shaping the land surface to eliminate minor differences in elevation and to smooth out depressions without changing the general contours of the land. The depth of cut in this operation is generally small and limited by the kind of equipment used. Land smoothing is also the finishing operation in land grading.

Land bedding. - Plowing, blading, or otherwise elevating the surface of flat-land into a series of broad, low ridges, separated by shallow, parallel dead furrows or field ditches. Also known as "crowning" or "ridging" in some localities.

Land leveling. - The shaping of the ground surface by grading and smoothing to a planned grade and to specifications required to permit the uniform distribution of irrigation water. Land leveling operations improve drainage. In some cases improved drainage may be the initial objective of land leveling and the application of irrigation water a delayed objective.

The diversion system

A ditch system, ditch, or dike which diverts water away from a lower-lying area or prevents water from flooding land.

Diversion ditch. - A graded channel constructed across the land slope to intercept and divert water to a suitable outlet. Its capacity may be enlarged by shaping the spoil into a continuous dike on one or both sides of the ditch.

Dike. - An embankment constructed of earth or other suitable materials to protect land against overflow from streams, lakes, and tidal influences; also to protect flat land areas from diffused surface waters.

Floodway. - A channel, usually bounded by dikes, used to carry flood flows. The dikes confine the flood flow to a small portion of the flood plain.

Water control system

A drainage system designed to regulate inflow and/or outflow of water.

Water control facility. - A ditch, drain, dike, dam, or pump, alone or in combination, and with or without auxiliary water control structures, designed to regulate the flow of water from, through, or to an area for the purpose of controlling the elevation of water.

Structure for water control. - A structure in an irrigation or drainage system for water management that conveys water, controls the direction or rate of flow, or maintains a desired water surface elevation in a natural or artificial channel. Also includes any structure for managing water levels for wildlife or other purposes.

Pumping plant for water control. - A pumping facility installed for removing excess surface or ground water from lowlands, or for pumping from wells, ponds, streams, and other sources.

References

- (1) GAIN, ELMER W.
1967. Land Drainage for Production of Food and Fiber Crops.
International Conference on Water for Peace, Washington, D. C.
Volume 7, pp 451-461.
- (2) INTERNATIONAL COMMISSION ON IRRIGATION AND DRAINAGE
1965. Annual Bulletin, ICID, New Delhi-21, India.

NATIONAL ENGINEERING HANDBOOK

SECTION 16

DRAINAGE OF AGRICULTURAL LAND

CHAPTER 1. PRINCIPLES OF DRAINAGE

Contents

| | <u>Page</u> |
|---|-------------|
| Scope | 1-1 |
| Elements of Drainage Design | 1-1 |
| Classification of drainage methods | 1-2 |
| Development of drainage-design criteria | 1-2 |
| Types of Drainage Problems | 1-3 |
| Surface-drainage problems | 1-3 |
| Subsurface-drainage problems | 1-3 |
| Basin-type free-water table | 1-4 |
| Water table over an artesian aquifer | 1-4 |
| Perched-water table | 1-5 |
| Lateral ground-water flow problems | 1-5 |
| Differences in Drainage in Humid and Arid Areas | 1-6 |
| Crop Requirements | 1-7 |
| Effects of excess water on crops | 1-7 |
| Drainage requirements determined by crops | 1-7 |
| Crop growth and the water table | 1-7 |
| Surface-Drainage Principles | 1-8 |
| Subsurface-Drainage Principles | 1-9 |
| Forms of soil water | 1-9 |
| Gravity water | 1-9 |
| Capillary water | 1-9 |
| Hygroscopic water | 1-9 |
| The water table and the capillary fringe | 1-9 |
| Principles of flow in the saturated zone | 1-10 |
| Hydraulic head | 1-10 |
| Hydraulic gradient | 1-12 |
| Paths of flow (streamlines) | 1-14 |
| Flow nets and boundary conditions | 1-14 |
| Permeability and hydraulic conductivity | 1-16 |
| Rate of flow | 1-18 |
| Sink formation in subsurface drainage | 1-19 |
| Theories of Buried Drain and Open Ditch Subsurface Drainage | 1-19 |
| Classification of drainage theories by basic assumptions | 1-20 |
| Horizontal flow theories | 1-20 |
| Radial flow theories | 1-20 |
| Combined horizontal and radial flow theories | 1-21 |
| Van Deemter's hodograph analysis | 1-21 |
| Transient flow concept | 1-21 |

| | |
|--|------|
| Techniques for applying drainage theories | 1-22 |
| Mathematical analysis | 1-22 |
| Relaxation method | 1-22 |
| Electrical analog | 1-22 |
| Models | 1-23 |
| Design Criteria | 1-23 |
| Drainage coefficients | 1-23 |
| Drainage coefficients for surface drainage | 1-24 |
| Drainage coefficients for subsurface drainage | 1-24 |
| Drainage coefficients for pumping plants | 1-25 |
| Drainage coefficients for watershed protection | 1-25 |
| Special requirements for flatland | 1-25 |
| Depth to water table | 1-25 |
| Pumped-Well Drainage | 1-25 |
| Classes of pumped wells | 1-26 |
| Water-table wells | 1-26 |
| Confined-aquifer or artesian wells | 1-26 |
| Theories of flow into pumped wells | 1-26 |
| Water-table wells | 1-26 |
| Confined-aquifer or artesian wells | 1-27 |
| Basis for design of pumped-drainage wells | 1-27 |
| Advantages of pumped-well drainage | 1-27 |
| References | 1-29 |

Figures

| | | |
|------------|--|------|
| Figure 1-1 | Illustration of hydraulic head | 1-11 |
| Figure 1-2 | Illustration of hydraulic gradient | 1-11 |
| Figure 1-3 | Equipotential surfaces | 1-13 |
| Figure 1-4 | Difference between hydraulic gradient and slope of the water table | 1-13 |
| Figure 1-5 | Flow direction in isotropic soil | 1-15 |
| Figure 1-6 | Flow direction in anisotropic soil | 1-15 |
| Figure 1-7 | Streamlines and equipotentials | 1-17 |

NATIONAL ENGINEERING HANDBOOK

SECTION 16

DRAINAGE OF AGRICULTURAL LAND

CHAPTER 1. PRINCIPLES OF DRAINAGE

Scope

This chapter presents basic principles and theories concerning the removal of excess water from agricultural land. In various branches of science, certain laws of flow have been discovered that apply to the movement of water on the land surface, within channels, and through the soil. Also, much empirical information providing a basis for the empirical methods of drainage design has accumulated over the years. Review of these fundamentals as they apply to drainage should be helpful to the engineer in correctly appraising drainage problems in the early stages of their investigation and working out their practical solution. A knowledge of drainage principles is necessary in developing local standards for drainage design. Existing drains need to be evaluated. Where local information for design criteria is lacking, experience from other places may need to be adapted for local use.

Although the fundamental equation for flow in saturated soils--Darcy's Law (1)* --has been known for many years, its application to most drainage problems is complex. Several approximate methods for solving these subsurface-flow problems have been developed. The basic assumptions in these methods are presented briefly in this chapter. Their limitations in practical application to field situations are also discussed.

Elements of Drainage Design

Generally, the installation of a drainage system, like any similar application of the sciences, includes a desired goal, a survey of existing conditions, previous experience with similar conditions, and preparation of designs and plans. In Soil Conservation Service operations, the principal elements of drainage design are crop requirements, site investigations, design criteria, and plans and specifications. Each of these elements will be treated in detail in this and in other chapters of this Section of the National Engineering Handbook.

At several points in the design procedure, it may be necessary to choose between alternate locations, methods, or materials. The choice depends on the management and economic aspects of the farm or ranch as well as on the physical requirements of the site. The designer may need to present to the landowner alternate methods or intensities of drainage, so that the owner may make the final choice.

The same technical design elements for individual farm systems are present for large group-drainage systems, but public or community-type factors also are involved. These factors include the drainage organization (drainage enterprise), legal requirements for rights-of-way and water disposal or use, financial arrangements, and cost allocation. Such projects require complete, detailed documentation of the surveys, plans, and construction.

*Numbers in parentheses refer to references listed at end of each chapter.

Classification of drainage methods

The methods used for land drainage may be classified in two broad categories-- surface drainage and subsurface drainage--depending on the way the water is removed.

1. In surface drainage, land surfaces are reshaped as necessary to eliminate ponding and establish slopes sufficient to induce gravitational flow overland and through channels to an outlet. Surface drainage may be divided into works which
 - a. remove water directly from land by land smoothing, land grading, bedding, and ditching
 - b. divert and exclude water from land by diversion ditches, dikes, and floodways.
2. In subsurface drainage, ditches and buried drains are installed within the soil profile to collect and convey excess ground water to a gravity or pumped outlet. The drop in pressure resulting from discharge induces the flow of excess ground water through the soil into the drains.
 - a. Interceptor drains are used to prevent entry upon the land when ground water moves laterally. Drains are oriented approximately at right angles to the direction of ground-water flow.
 - b. Relief drains are used when land surfaces are nearly flat, flow velocities low, or interception of ground water ineffective. Drains are commonly (but not necessarily always) oriented approximately parallel with the direction of ground-water flow.

Development of drainage-design criteria

Design criteria are developed in two general ways: (a) from empirical data collected through evaluation of existing drainage systems, and (b) from a theoretical analysis of the problem, applying known physical laws and testing the theory through evaluation of existing drainage systems.

An example of empirical criteria are the drainage coefficients used in design of drains in humid areas. Such coefficients are the removal rates for excess water, found by experience with many installed drainage systems, to provide a certain degree of crop protection. Such protection has been assessed carefully against observed crop response and production, measurements of flow from drainage systems providing good drainage, and measured heights of water table. Since empirical criteria are based substantially on experience and assessments of numerous interrelating factors, care must be taken in transposing their use from one locality to another.

Theoretical analysis applies proved principles or laws to problems having known limiting conditions. The resulting mathematical expression explains the observed action of existing drainage systems and permits the rational design of new systems. Usually several variable site factors enter the expression. An example of the theoretical analysis is the ellipse equation for spacing subsurface drains in irrigated land, where known site characteristics are accounted for in the equation. In one form of the ellipse equation, the variables are hydraulic conductivity of the soil, depth to impermeable layer, depth to the water table at

midpoint between the drains, and rate water is to be removed. By substituting known or estimated values for these factors, the equation may be applied to a variety of sites, as long as the site conditions are within the limits for which the equation was derived. This last requirement is all important in using this kind of theoretical approach.

Whichever method is used to establish drainage-design criteria, it is evident that its value depends not only on sound analysis of the drainage situation but also on evaluation of installed drains to check their performance.

Types of Drainage Problems

Successful drainage of a wet area depends on a correct diagnosis of the problem. At some sites, a brief field study and comparison with previous installations under similar conditions may be a sufficient basis for design. More complex drainage problems require more detailed reconnaissance and preliminary surveys to determine the source of damaging water, how water reaches the wet area, and what design criteria apply. The drainage system may be designed, however, only after the nature of the problem has been identified.

The following typical drainage problems have been divided into surface and sub-surface problems for convenience. Actually, wet land may involve both surface and subsurface water, and the drainage design should consider their inter-dependence.

Surface-drainage problems

Flat and nearly flat areas of land are subject to ponded water caused by:

1. Uneven land surface with pockets or ridges which prevent or retard natural runoff. Slowly permeable soils magnify the problem.
2. Low-capacity-disposal channels within the area which remove water so slowly that the high water level in the channels causes ponding on the land for damaging periods.
3. Outlet conditions which hold the water surface above ground level, such as high lake or pond stages, or tidewater elevations.

Sources of surface water are rainfall or snowmelt on the area itself, irrigation-surface waste, runoff or seepage from adjoining higher land, or overflow from stream channels.

Surface-drainage methods, such as land grading or smoothing and field ditches, are used on fields to collect and convey surface water to natural channels or constructed disposal systems. Inadequate outlets may require downstream-channel improvement, levees with culverts and flapgates, or drainage pumps. Diversion systems are efficient in preventing or reducing the ponding of surface water where the source is outside the area to be protected. These and other features of surface-drainage systems will be described more fully in other chapters.

Subsurface-drainage problems

Subsurface-drainage problems arise from many causes. Flatland tends to be poorly drained, particularly where the subsoil permeability is low. There are many wet areas, however, where there is no evident connection between the area of seepage, or a high water table, and the topography of the site. High water tables may

occur where the soil is either slowly or rapidly permeable, where the climate is either humid or arid, and where the land is either sloping or flat.

For these reasons, it is convenient to classify subsurface-drainage problems by the source of excess ground water and the way it moves into and through the problem area. This method of identifying subsurface conditions is especially useful for the more complex drainage problems because it also indicates the kind of drainage system needed. The reconnaissance and preliminary surveys are carried out to obtain the needed information on ground-water occurrence and other site conditions. Detailed information is in Chapter 2, Drainage Investigations. As experience with subsurface-drainage problems accumulates for a given area, the amount of preliminary information needed to identify certain problem types usually is reduced. New areas or new kinds of drainage problems require greater emphasis at the preliminary stage of planning.

The following examples illustrate some of the more important types of subsurface-drainage problems. Particular emphasis is given to the source and direction of ground-water flow. Detailed design of drainage systems for subsurface drainage is discussed in Chapter 4, Subsurface Drainage. Refer to the figures in Chapter 4 for illustration of most of the drainage problems described below.

Basin-type free-water table

In valley bottoms and on wide benchlands, the free ground water saturates the sediments down to the first impervious barrier. Typically, the water table slopes gently downvalley. This large, very slowly moving body of ground water is fed by springs, surface streams, or subsurface percolation around the perimeter of the valley; and by infiltrating rainfall, irrigation losses, or surface runoff on the valley floor itself. Eventually, the ground water discharges effluent seepage at streambanks or at the ground surface in low areas, or except for ground water used by plants or that pumped from wells, it escapes through aquifers at the lower end of the valley or benchland. Height of the water table fluctuates with the seasonal variation of accretions to the ground-water basin. The general slope of the water table varies only slightly in response to these changes in inflow. Where salts are present in the soil, they tend to move upward to the surface as capillary rise replenishes the evaporation from the ground. Phreatophytes grow where the water table is close to or at the surface.

Relief drains may be used to lower the water table in such areas, unless soil permeability is too low. The ground-water slope is too nearly flat and the pervious sediments are too deep for efficient interception (except, perhaps, at the sides of valleys near the base of the hills or the alluvial cones). Where economically feasible, pumped-drainage wells are sometimes used to lower the basin-type water table.

Water table over an artesian aquifer

Ground water may be confined in an aquifer so that its pressure surface (elevation to which it would rise in a well tapping the aquifer) is higher than the adjacent free-water table. The pressure surface may or may not be higher than the ground surface. Such ground water is termed artesian. Pressure in the aquifer is from the weight of a continuous body of water extending to a source higher than the pressure surface. Leaks at holes or weak points in the confining layer above the aquifer create an upward flow, with hydraulic head decreasing in the upward direction. The ground water moves in response to this hydraulic gradient and escapes as seepage at the ground surface above, or it escapes laterally through other aquifers above the confining layer.

A water table supported by artesian pressure usually is more difficult to lower and maintain at the desired height than a water table not subject to such pressure. This is because water is continuously replenished from the higher source and because it is difficult to remove or control water at the source. Wet areas overlying water under artesian pressure require relatively deep and closely spaced drains, relief wells, or pumped-drainage wells that tap the aquifer. Such areas may be impractical to drain.

The drainage system required to control artesian flow may depend on the kind of underlying material. The upward flow from the source aquifer may reach the water table through a stratum of fairly uniform material, or it may pass through fractures or other narrow openings in sandstone, clay, lava, limestone, or other materials that in themselves are practically impermeable. Surface seeps in some places are caused by artesian flow that wells up through relatively small openings in the confining material, causing ground-water mounds or surface seeps. This kind of seep usually may be drained by placing a relief drain as deep as practicable through the seepage zone. Additional intercepting drains may be needed to pick up flow that escapes laterally above the confining layer.

Perched-water table

In stratified soil, a subsurface-drainage problem may be caused where excess water in the normal root zone is held up by a layer of low permeability so that the perched water is disconnected from the main body of ground water. This may occur when surface sources build up a local water table over the slowly permeable layer. Lateral percolation is too slow to drain the perched water naturally.

Drainage systems for perched-water tables are based on the particular site conditions. Usually they consist of relief drains, but an interception drain may be effective in cutting off lateral seepage into the wet area. Theoretically, perched water could be drained downward by drilling vertical drains (wells) through the restrictive layer. A collection-drain system probably would be necessary, however, and the vertical drains might be impractical outlets for economic or other reasons. Perched-water tables in irrigated areas may be subject to control by reducing seepage from canals, by improving irrigation practices, or by providing adequate surface drainage.

Lateral ground-water flow problems

This group of subsurface-drainage problems is characterized by more or less horizontal ground-water percolation within or toward the crop-root zone. The flow pattern is strongly influenced by soil stratification and other natural barriers to flow.

Adjacent soil layers often have permeabilities that differ a hundred or a thousand fold. According to Darcy's law of flow, the effective velocity under a given gradient varies directly with the permeability. Flow of ground water is discussed further in the section on "Subsurface-Drainage Principles." All significant flow may be limited to the more permeable layers. The depth, orientation, and inclination of the strata determine the drainage method and location. For example, hillside seepage may appear where ground water moves laterally over bedrock or over a layer of fine sediments to a point where it emerges at the surface. One or more intercepting drains may be used to cut off the flow which otherwise would reach the root zone.

Alluvial fans and valley bottoms commonly contain sand or gravel deposits. These occur in a variety of ways, as in deep extensive layers, narrow "stringers" (old streambed locations), lenses, or in highly stratified soil profiles. Such

rapidly permeable deposits may serve as channels for ground-water movement in some places at high rates of flow. A soil layer of low permeability overlying such an aquifer may create a degree of confinement, which in turn develops an upward hydraulic gradient, particularly if the lower end of the aquifer is closed or of reduced permeability. Interception drains are effective where the aquifer is close enough to the surface so that it is feasible to cut off the flow. Relief wells or pumping may be used where interception is not practical.

Subsurface soil masses of low permeability, such as clay lenses and offshore clay bars formed in the geologic past, are local barriers to ground-water flow. They may cause the water table to be held to a high level and the flow to escape around or over the barrier. Permeable layers that become thinner or gradually decrease in permeability in a downstream direction have a similar effect on the water table. Drains placed just upslope from the restriction usually are effective in these situations. Irrigation canal seepage creates another kind of lateral ground-water flow problem. An intercepting drain at the toe of a canal bank or river levee may cut off much of the flow that would reach the wet area where a horizontal barrier forms a convenient "floor" for interception. However, the designer must consider the steeper hydraulic gradient such a drain causes and evaluate its effect on the canal-seepage loss and on the stability of the embankment against sloughing or piping. River seepage through or under levees creates similar problems.

These examples illustrate the unlimited variety of subsurface-drainage problems. The principles of interception, relief, or pumped-well drainage may be applied to each according to the pattern of subsurface flow. The pattern of flow becomes known from a field investigation of soil stratification, water source, and water table or pressure data.

Differences in Drainage in Humid and Arid Areas

Drainage in humid areas has to do largely with excess water resulting from precipitation; in arid and semiarid areas, the need for drainage arises principally from irrigation, with foreign ground water an important source in some areas.

Surface-drainage systems may be required in either humid or in irrigated areas. Surface drainage is usually an integral part of irrigation systems on slowly permeable soils or in areas of high precipitation rates.

The purpose of subsurface drainage is to lower the water table to a point where it will not interfere with plant growth and development. The minimum depth at which the water level should be maintained varies according to both the crop requirement and the soil. One of the principal factors in the height of the water table in arid areas is control of salinity and alkalinity in the soil and ground water. This is a major reason for the difference in the subsurface drainage of humid and of arid climates.

The depth of drains in humid climates is generally 3 to 5 feet. Water is relatively pure, there usually is a natural excess of water over plant requirements, and there is a net downward movement of ground water.

Soils in semiarid or arid climates require subsurface drains at least 5 to 7 feet deep. Most of the water needed by the crop is added by irrigation. Usually ground water is somewhat saline because of salts in the soil, the irrigation water, or both. A water table as high as 24-30 inches below the surface, suitable in many humid areas, would create a harmful salt concentration in the root zone in arid areas.

Crop Requirements

Effects of excess water on crops

The growth of most agricultural crops is sharply affected by continued saturation of any substantial part of the root zone or by ponded water on the surface. Poorly drained soils depress crop production in several ways:

1. Evaporation, which takes heat from the soil, lowers soil temperature. Also, wet soil requires more heat to warm up than does dry soil, due to the high specific heat of water as compared to that of soil. Thus, the growing season is shortened.
2. Saturation or surface ponding stops air circulation in the soil and prevents bacterial activity.
3. Certain plant diseases and parasites are encouraged.
4. High water table limits root penetration.
5. Soil structure is adversely affected.
6. Salts and alkali, if present in the soil or ground water, tend to be concentrated in the root zone or at the soil surface.
7. Wet spots in the field delay farm operations or prevent uniform treatment.

Drainage requirements determined by crops

Different crops have widely differing tolerances for excess water, both as to amount and time. While water itself may not be injurious to plant roots, saturation of the root zone results in an oxygen deficiency and accumulation of toxic gases. A short term of oxygen deficiency can reduce water uptake, nutrient uptake, and root respiration and build up toxins which leads to death of cells and roots, and, if extended, the death of the plant itself. However, complete saturation of roots over an extended period may cause no serious damage if it occurs during dormant periods of plant growth or flow from drainage is sufficient to supply some oxygen and remove toxic gases. The designer of a drainage system recognizes these differences in crop requirements by selecting an appropriate degree or intensity of drainage (often termed the drainage requirement) for the site. The drainage requirement is based on (a) the maximum duration and frequency of surface ponding, (b) the maximum height of the water table, or (c) the minimum rate at which the water table must be lowered. The local drainage guide indicates the drainage criteria required for various crop-soil combinations. Further information and guidance can be obtained from reports of continuing research on effects of flooding, water table depths and soil gases on agricultural crops (2).

Crop growth and the water table

The water table may be defined as the upper surface of the saturated zone of free, unconfined ground water. (A more accurate definition has been made in terms of water pressures and film tensions.) The soil-moisture content for a significant height above a water table is substantially greater than field capacity. For this reason, plant-root growth is affected by a water table much more than the height of water table alone indicates.

Another important feature of water tables is their fluctuation, both seasonal and short-period. Water tables are seldom static. They respond to additions and depletions of ground water from natural or artificial causes. Sources such as distant-influent seepage from precipitation and streamflow are seasonal, and their effects on the wet area may be delayed for months or even years. Direct precipitation and irrigation-percolation wastes, of course, may change the water-table height almost immediately.

Pumping from deep wells may cause a gradual lowering of the water table as water is taken from a large basin of free ground water. In other areas, pumping may make significant immediate changes in the height of water table due to pressure changes in confined water which "supports" the water table.

In the field of drainage, it is important to think of the true relation of the water table to root development and crop production. The term "water table" is sometimes misleading. Capillary forces and fluctuating ground-water flows result in soil-moisture conditions that are different from the erroneous concept of a sharp break from saturation to a much lower moisture content such as field capacity. A considerable amount of ground water is present and moves through the saturated and nearly saturated soil immediately above the water table.

Surface-Drainage Principles

Surface drainage is accomplished in two general ways: (a) excess water is collected and removed from the ground surface within the area affected; or, (b) by means of construction outside the area, water is diverted away from the area to be protected. In either case, the system is conveniently divided into three functional parts:

1. Collection system. Bedding, field ditches, row ditches, or diversion ditches are part of the system that first picks up water from the land.
2. Disposal system. This is the part of the system that receives water from the collection system and conveys it, usually in an open ditch, to the outlet.
3. Outlet. This is the end point of the drainage system under consideration.

Fundamentally, surface drainage uses the potential energy that exists due to elevation to provide a hydraulic gradient. The surface-drainage system creates a free-water-surface slope to move water from the land to an outlet at a lower elevation. The design of collection systems, such as bedding or field ditches in flatland is based mostly on empirical criteria; i.e., the design is based on field observations of drainage-system performance. The rate at which surface water must be removed from the land is a function of the crop requirement and the source of excess water.

The water-surface profile is the starting point in the design of the disposal-system ditches. In open ditches, the hydraulic gradeline is the water-surface profile. Usually, the survey of the surface-drainage outlet establishes the lower hydraulic-control point for the design of the disposal system. Other control points are the land elevations at critical low areas and restrictions in the ditch, such as culverts, bridges, and weirs. The design of a disposal system involves, therefore, the computation of a water-surface profile through the control points, for known or trial ditch cross sections.

Bernoulli's theorem is used to compute the hydraulic gradeline for steady-flow conditions. Losses of head due to friction are computed by an open-channel formula, usually Manning's. Head losses at constrictions causing nonuniform flow, such as at bridges or culverts, are computed by formula using appropriate loss coefficients. The field survey must include sufficient information for evaluation of the roughness and cross-section factors, including head loss through obstructions.

In drainage design, nonsteady flow may occur as in discharge into tidal streams. Such problems may sometimes be solved by dividing time into convenient increments within each of which the varying flow may be taken as a constant, mean-flow rate.

Subsurface-Drainage Principles

Forms of soil water

Gravity water

Water that is free to move downward through the soil by the force of gravity is called gravity water. At saturation, all pores are filled and the soil holds the maximum amount of water that can be absorbed without dilation. (Dilation is the bulking or flotation of soil grains.)

Capillary water

Capillary water is held in the soil against gravity. It includes the film of water left around the soil grains and the water filling the smaller pores after gravity water has drained off.

If gravity water is allowed to drain from a saturated soil (not influenced by a water table), the quantity of capillary water held is called field capacity. Close to the water table, the quantity of capillary water held in a granular material is greater than field capacity. The amount of water held at a given point depends on the distance above the water table, as well as on the soil pore sizes and shapes. This form of capillary water is sometimes called fringe water. Just above the water table, fringe water completely fills the capillary pores, and in this relatively narrow zone, saturation occurs at slight negative pressure (tension). Openings so large that capillary rise in them is negligible are called supercapillary openings. Examples of materials containing supercapillary openings are gravel, boulders, some forms of lava, structurally fractured rock or clay, solution openings in rock, and soil containing root holes.

Hygroscopic water

When a granular material is completely dried by heating, then exposed to the air, it absorbs atmospheric moisture. This water, when in equilibrium with the atmospheric moisture, is called hygroscopic water.

The water table and the capillary fringe

The water table is the upper surface of the saturated zone of free ground water. Free ground water is defined as water neither confined by artesian conditions nor subject to the forces of surface tension. At the water table, water pressure is at atmospheric pressure. Thus the water table is the imaginary surface separating capillary water (under tension) from the free ground water below.

The water table in granular material is not an observable, physical surface because capillary water saturates the material just above the water table and decreases in amount gradually upward. An exception is water in supercapillary

openings, in which the water is in equilibrium with the atmosphere. Auger holes and piezometers are supercapillary in size and open to the atmosphere, and so they fill to the true water-table level when bored or driven just into the water table.

When an auger hole is bored to locate the water table in a fine or medium-textured soil, the observer finds it difficult to recognize the top of the saturated zone because of the gradual change from moist to saturated soil. Also, it may take hours or even days for an auger hole to register the water table in slowly permeable soils. Small wells or piezometers react more quickly than large ones because less water need flow through the soil to fill the smaller openings.

Water in the capillary fringe may be a significant proportion of ground water moving toward subsurface drains--as much as 20 percent or more under some conditions.

An auger hole or pipe should penetrate the saturated zone only a short way if the water-table elevation is to be measured accurately. This is particularly important where upward flow or confined flow would be tapped by a deeper hole. An auger hole that penetrates two or more aquifers in a stratified soil containing confined water would register the highest hydraulic head modified by leakage from the aquifers of higher hydraulic head to those of lower head.

These characteristics of the water table have a significant bearing on the kind of field measurements to be made, on the devices used to make the observations, and on the interpretations of data for drain-system design.

Principles of flow in the saturated zone

Flow of water in the saturated zone involves mechanical, chemical, and thermal energy, and molecular attraction. A full discussion of soil-water movement is in numerous publications on soil physics and soil permeability. Here only the mechanical forces tending to move water through soils will be considered.

Hydraulic head

In saturated flow through soils, as in open channel flow, the total energy content (E) of water is the sum of the kinetic, pressure, and gravity components. As expressed in Bernoulli's equation:

$$E = \text{kinetic energy} + \text{pressure potential} + \text{elevation potential.}$$

Velocities in ground-water flow are almost always low, making the velocity (kinetic) term negligible. Essentially, then, the energy causing flow is the sum of the two potential energy items, pressure and elevation. This potential for flow is called "hydraulic head."

In the English system of units, energy is expressed foot-pounds. Hydraulic head is conveniently expressed as the energy content per unit weight of water, or foot-pounds per pound, which is feet, dimensionally. Thus, the hydraulic head (fig. 1-1), at a given point is:

$$H = \frac{P}{W} + Z$$

where H = hydraulic head, ft.; P = pressure at the point referred to the atmosphere, lb/ft²; W = specific weight of the water, lb/ft³; and Z = elevation of the point above a datum, ft.

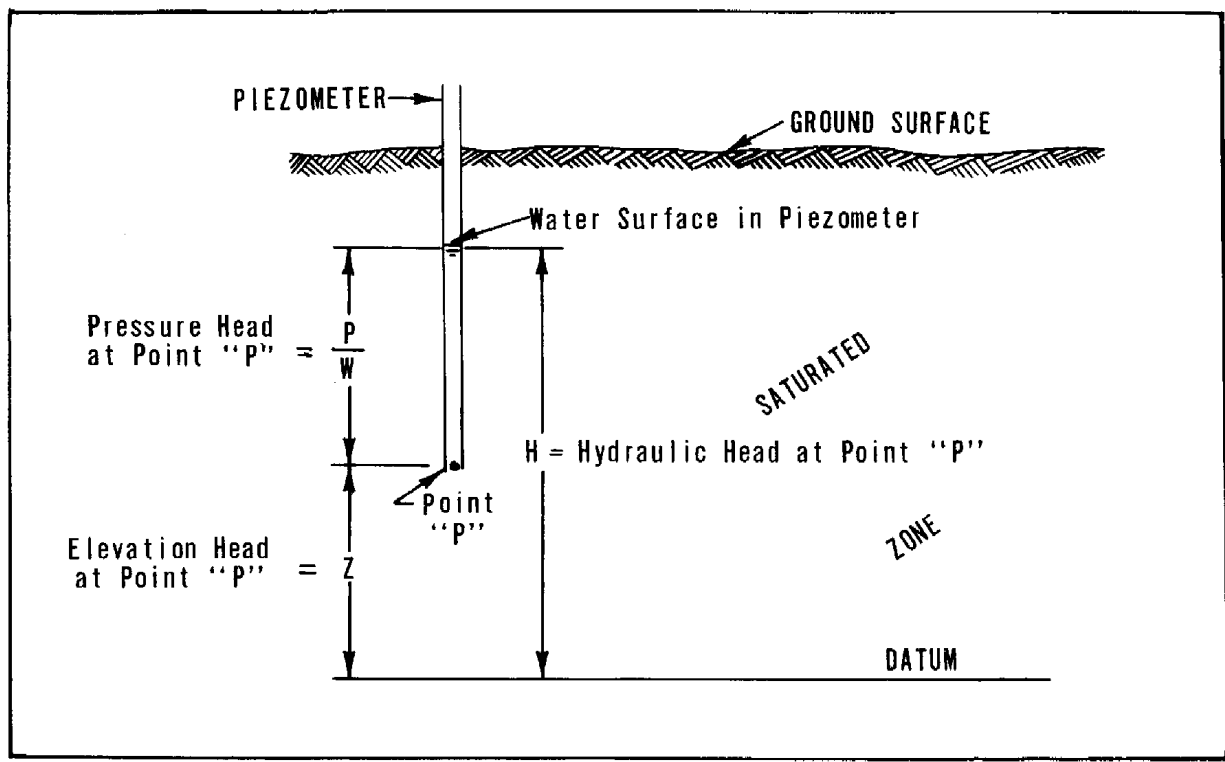

Figure 1-1, Illustration of hydraulic head

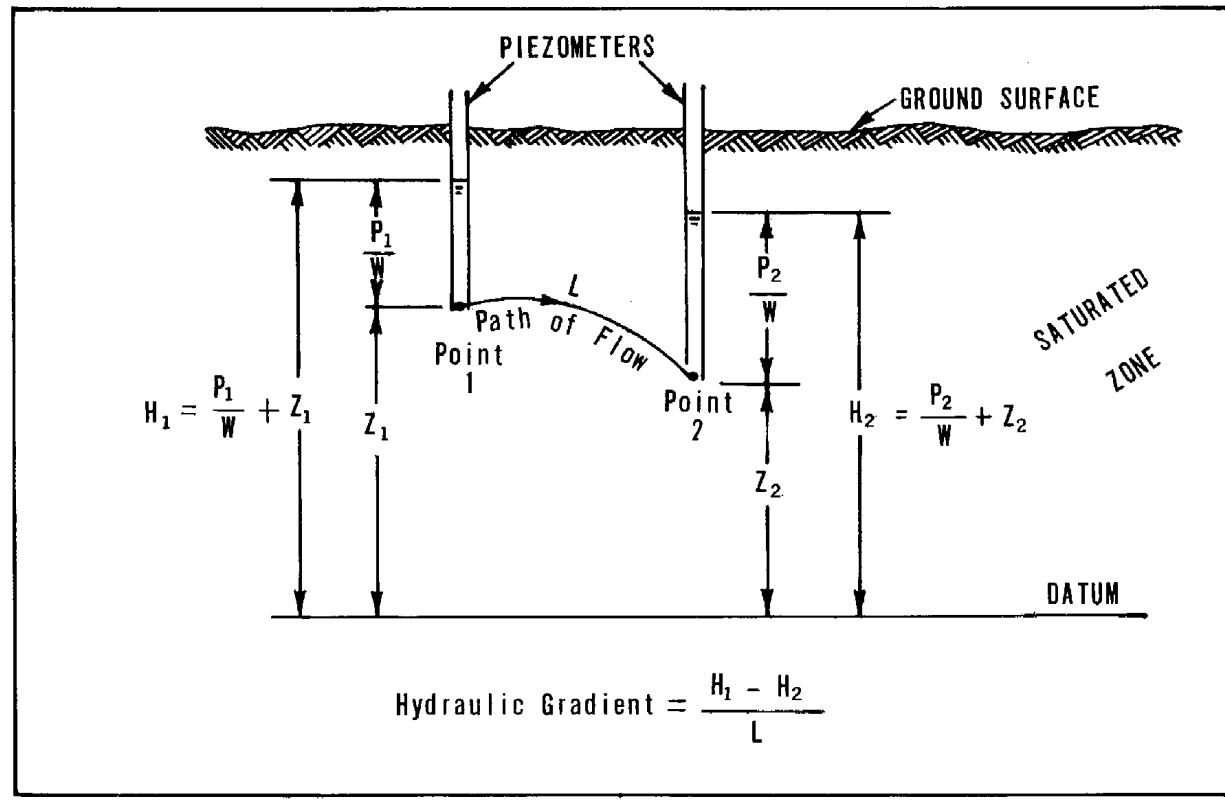

Figure 1-2, Illustration of hydraulic gradient

Piezometers convert pressure at a point to a physical pressure head the height of the water column in the piezometer. This height is not hydraulic head, since it is only the term P/W in the equation. To find the hydraulic head at the point (lower end of the piezometer) the elevation (Z) of the point above the datum must be added to the pressure head. The elevation of the water surface in the piezometer, referred to the datum, is $P/W + Z$, and so is numerically equal to the hydraulic head at the lower end of the piezometer.

Hydraulic gradient

Ground-water flow results from the force "available" to move water through the soil due to differences in energy content; i.e., differences in hydraulic head. This is analagous to the flow of heat or electricity, where flow is due to differences in temperature (heat potential) or differences in voltage (electrical potential). Hydraulic gradient is the difference in hydraulic head at two points, divided by the distance between the points measured along the path of flow (fig. 1-2). In this figure, the plane of the paper is a vertical surface through the path of flow.

$$\begin{aligned} \text{Hydraulic Gradient} &= \frac{H_1 - H_2}{L} \\ &= \frac{\left(\frac{P_1}{W} + Z_1\right) - \left(\frac{P_2}{W} + Z_2\right)}{L} \end{aligned} \quad (\text{Eq. 1-1})$$

where L = distance measured along the path of flow, ft.

Subscripts 1 and 2 refer to the points of the higher and lower hydraulic head, respectively; other units are defined in the preceding paragraphs.

In a given flow system (fig. 1-3) each "particle" of water in the system has its corresponding hydraulic head. All particles or points, of a given hydraulic head (H_1) lie in the corresponding equipotential surface (H_1). All points of hydraulic head H_2 lie in the equipotential surface H_2 , and so on. The force tending to produce flow acts in the direction of greatest decrease in hydraulic head; i.e., normal to the equipotential surface, as F at point P , or F' at point P' . The magnitude of this force is proportional to the hydraulic gradient at the point.

At the water table, the pressure component of energy (P/W) is zero relative to atmospheric pressure. Therefore, the hydraulic head H of a point at the water table is Z , the elevation of the point above the datum.

Water-table slope represents the hydraulic gradient of flow only under certain conditions. Hydraulic gradient may differ greatly from the water-table slope where there is significant upward or downward component of flow such as in the vicinity of pumping wells or subsurface drains, in flow from artesian aquifers, and in unsaturated seepage from canals. As shown in figure 1-4, slope of the water table is $\frac{H_1 - H_2}{S}$ (or tangent of the angle) by definition. S is the horizontal

projection of the path of flow L . But the hydraulic gradient is $\frac{H_1 - H_2}{L}$

(or sine of the angle). On flat gradients and with parallel flow, the water-table slope is essentially the hydraulic gradient because $S = L$ nearly (tangent is nearly the same as the sine for small angles). It should be noted that the

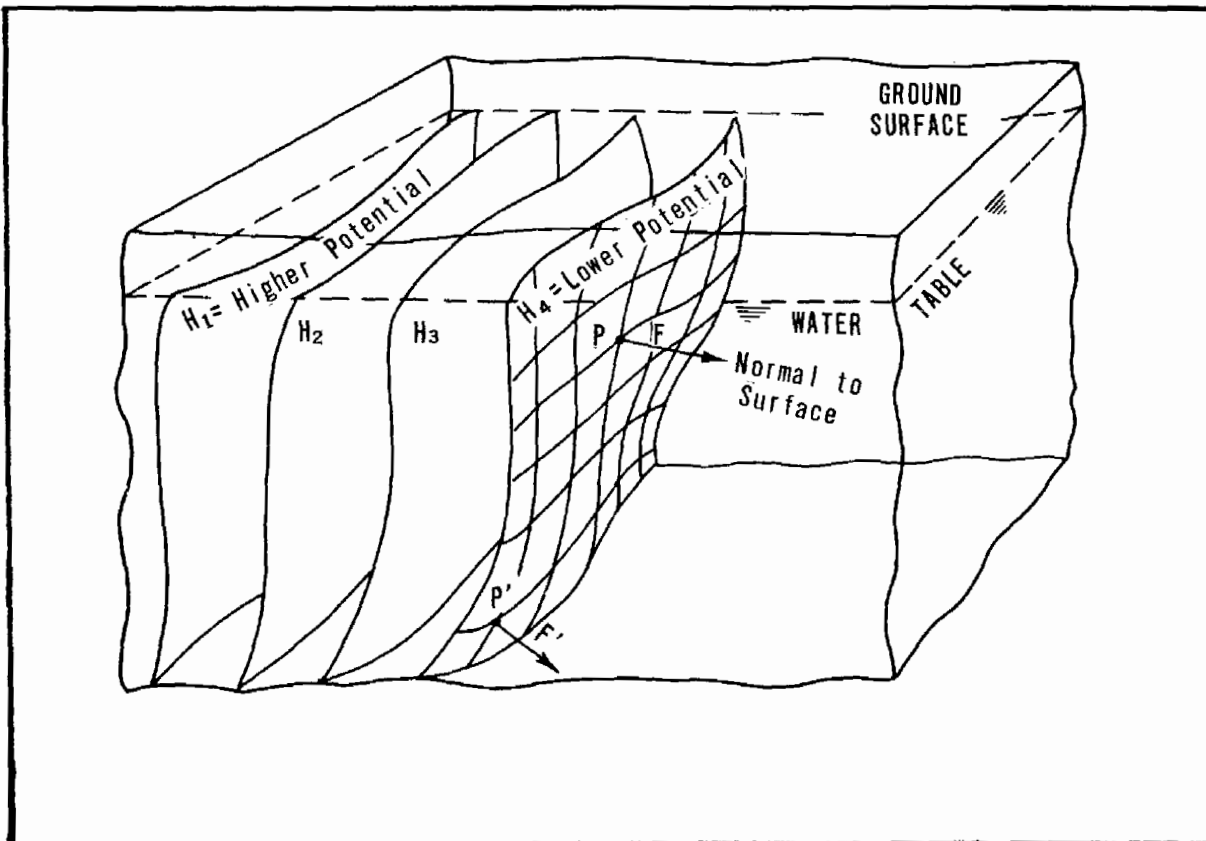

Figure 1-3, Equipotential surfaces

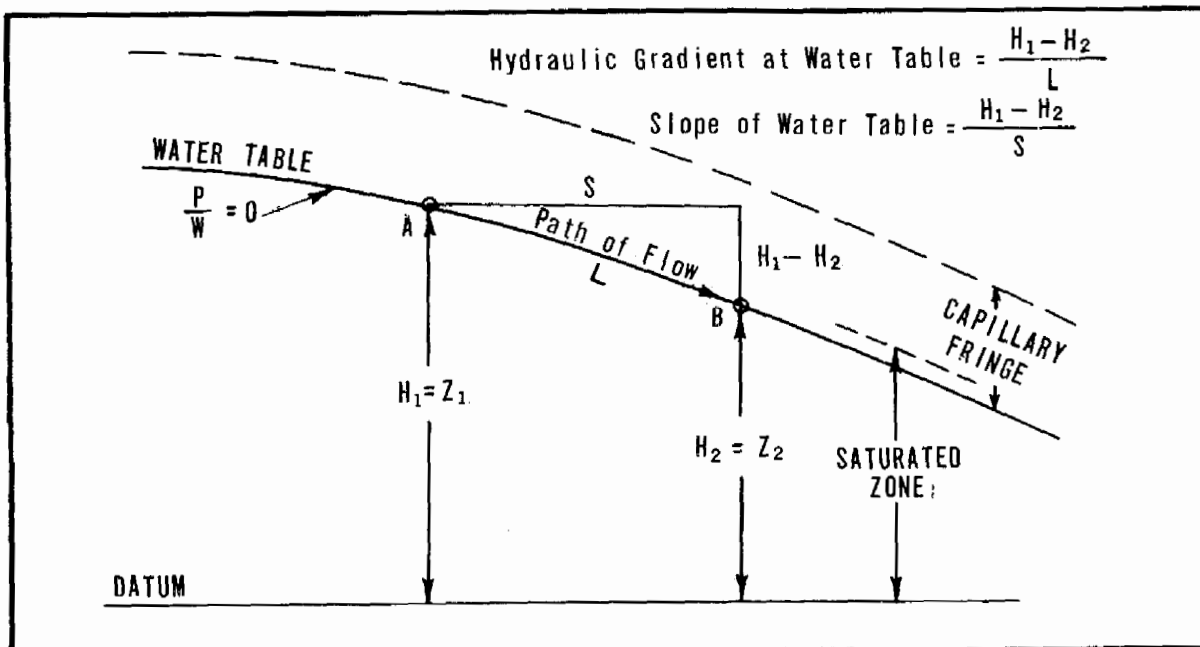

Figure 1-4, Difference between hydraulic gradient and slope of the water table

water table is not invariably a path of flow; water may be flowing down from or up into the unsaturated zone, thus crossing the water table.

Paths of flow (streamlines)

The force due to hydraulic gradient tends to move water along the line of force normal to the equipotential surfaces. Whether the flow moves actually in the same direction as the line of force depends on whether the soil has the same hydraulic conductivity in all directions. If the soil is "isotropic," i.e., if its hydraulic conductivity is the same in all directions, the path of flow will be along the lines of force and perpendicular to the equipotential surfaces.

If the soil has a higher hydraulic conductivity in one direction than in another direction, the path of flow will not be perpendicular to the equipotential surface. Such a soil is said to be "anisotropic." Water-laid soils often have bedding planes or particle orientation causing them to be anisotropic. The paths of flow in anisotropic soils will be perpendicular to the equipotential surfaces at points where the lines of force are exactly parallel to or normal to the bedding plane. A soil with microstratification (thin layers with widely different hydraulic conductivities) will cause water to flow in a way similar to the flow in an anisotropic soil.

Many flow systems common in soil drainage may be studied in two dimensions rather than three, because of uniformity in the third dimension. Equipotential lines then represent the intersection of the plane of the paper with the equipotential surfaces. An example of this representation is the flow into a system of parallel drains, where the flow is at right angles to the drains.

A two-dimensional system on the X-Y plane is illustrated in figure 1-5. The soil is isotropic (hydraulic conductivity is uniform in all directions) in figure 1-5. Figure 1-6 shows another soil, with a line of force normal to the equipotential line and at an angle b to the vertical axis Y. But in this soil, which is anisotropic, the horizontal hydraulic conductivity K_h exceeds the vertical hydraulic conductivity K_v . The direction of flow is not along the line of force, but along a line closer to the horizontal axis. It may be shown that the angle the path of flow makes with the horizontal is

$$a = \tan^{-1} \frac{K_v}{K_h \tan b}$$

Thus, the flow pattern may be computed and drawn for an anisotropic system if the equipotential lines are known, and if the relative hydraulic conductivities K_v and K_h are known.

In analyzing the direction of flow of ground water, the investigator should be aware of the effect of anisotropic soils on the flow pattern.

Flow nets and boundary conditions

Flow in the saturated zone often is studied by means of graphic representations of hydraulic head and paths of flow. Cross sections are taken through the problem area, usually in vertical planes. Lines connecting points of equal hydraulic head

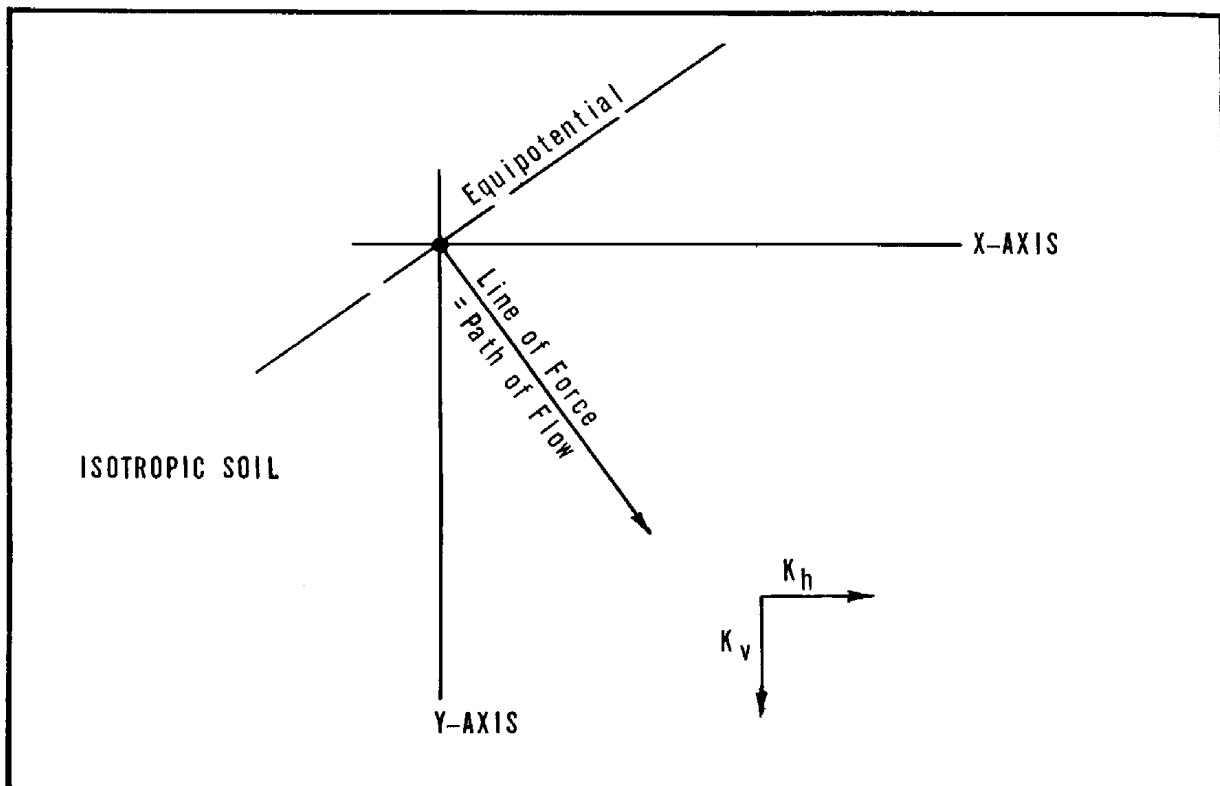

Figure 1-5, Flow direction in isotropic soil

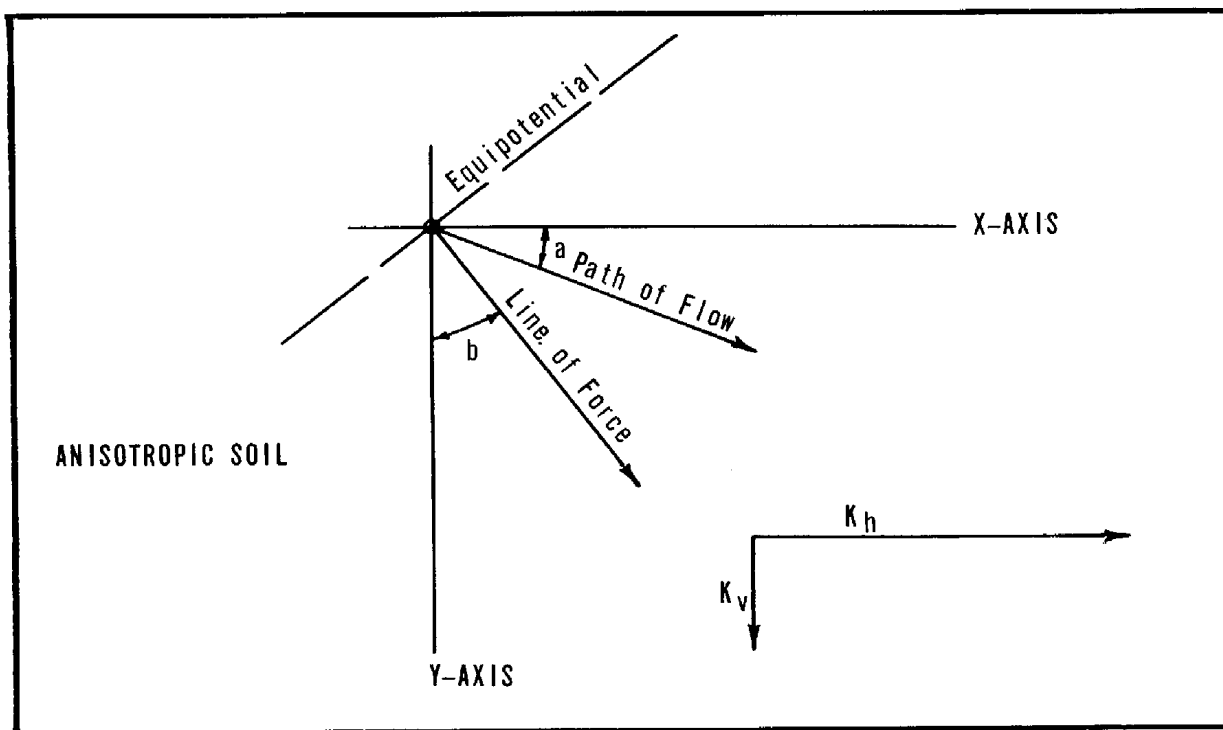

Figure 1-6, Flow direction in anisotropic soil

on such planes are called equipotential lines, or "equipotentials." Lines indicating the paths of flow are called "streamlines." A graph showing equipotentials and streamlines for a flow system or part of a flow system is called a "flow net."

The flow net is the result of the operation of Darcy's Law in a system where there are certain sources of water and certain constraints to flow. These conditions that govern the pattern of flow in a ground-water system, when taken together, are called "boundary conditions." Topography, location and quantity of water source, stratigraphy, and drain locations are the principal items making up the boundary conditions. A field survey of these elements is a basis for (a) isolating the flow system to be studied, and (b) designing the drainage system.

Figure 1-7 illustrates two flow nets in saturated soils. Each is taken in a vertical plane at right angles to a drain, with the soil saturated to the surface and an impermeable layer at twice the drain depth. The drain is one of several equally spaced drains. The upper flow net is for an isotropic soil. The lower flow net is for the same boundary conditions except that the soil has a horizontal permeability 16 times its vertical permeability (anisotropic). Numbers on each streamline indicate the percent of the total flow which occurs to the left of that streamline. Note that 50 percent of the flow reaching the drain through the isotropic soil originates in a strip over the drain and covering about one-fourth of the source area. For the soil with horizontal permeability 16 times greater than the vertical, 50 percent of the flow originates in a much wider strip, covering nearly one-half of the source area.

If the water source were cut off at the soil surface, the water table would drop in both cases, but the drop would be much more uniform in the second case. This same effect is observed in layered soils, except that the flow net, while having the same general shape, would show sharp breaks in direction where the lines crossed from one stratum to another.

Flow nets may be plotted from actual field measurements of hydraulic head in piezometers. A drainage problem is sometimes reproduced in a laboratory tank model, from which flow data may be taken more readily. Electrical analogs provide additional useful tools for setting up some drainage problems. Flow nets are readily plotted from electrical analog data. There are also methods of computing arithmetically the hydraulic head throughout actual or idealized flow systems. However, numerical methods are tedious for complex problems.

Flow nets are used to study such special problems as the depth and spacing of drains, the best location for a drain conduit designed to intercept flow over an impermeable layer, the effect of pervious backfill in less permeable soil, the quantity of flow entering the bottom half of a buried drain, and canal seepage. Such special conditions may justify flow-net analysis for an individual drain design, but this technique is more often employed in research or evaluation work.

Permeability and hydraulic conductivity

"Permeability" of a porous medium such as soil is its capacity to transmit fluids. It is used as a qualitative term; i.e., it is used as a term for this property of soil. The term is also modified to describe the relative ease of transmission, as "rapidly permeable," or "slowly permeable."

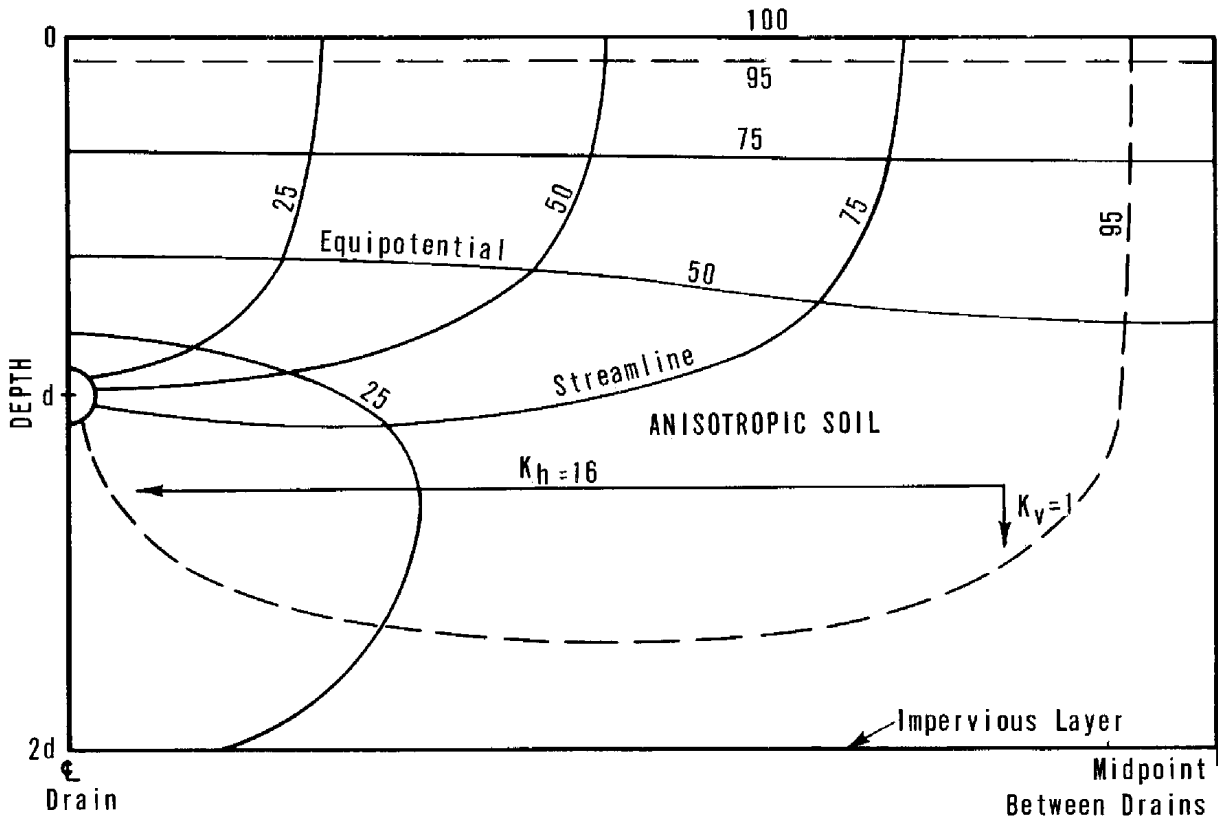
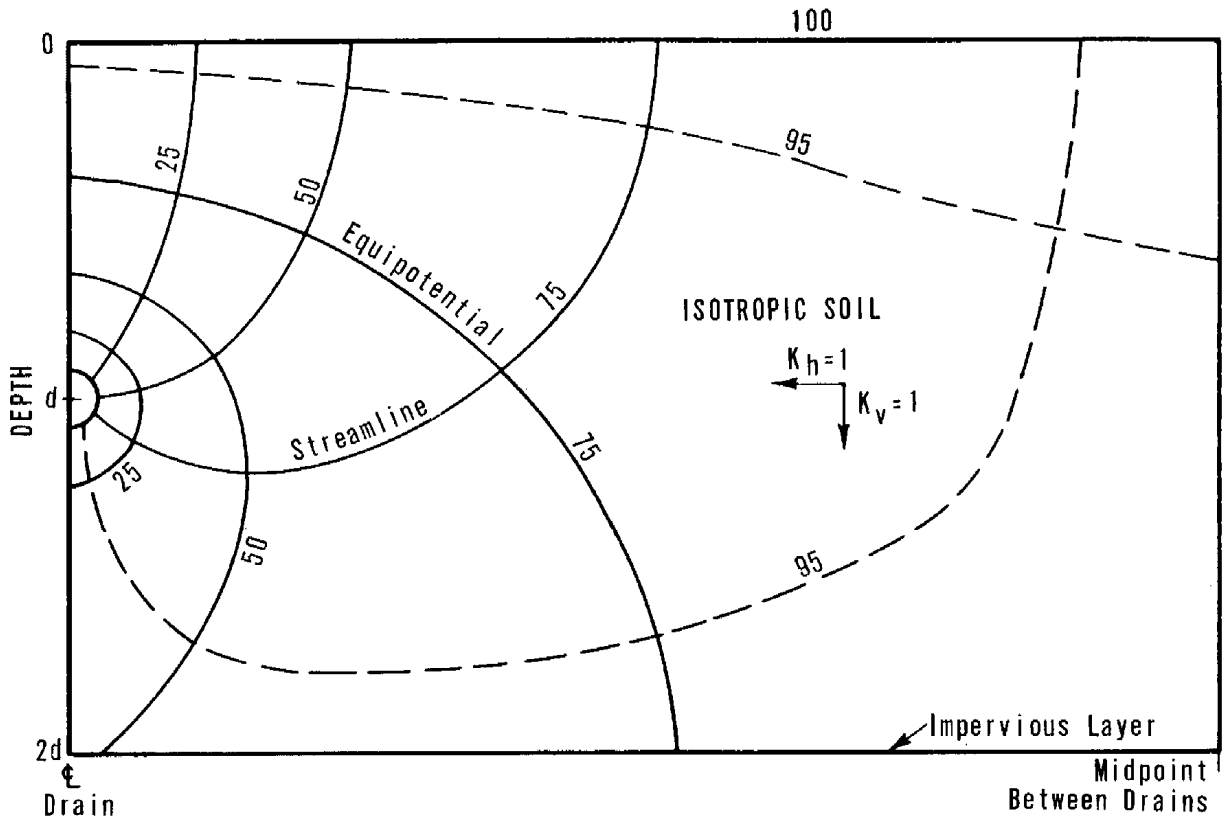

Figure 1-7, Streamlines and equipotentials

"Hydraulic conductivity" of a soil is a numerical value for permeability. It is equal to the proportionality factor K in the Darcy equation. The Darcy equation is an expression of effective velocity of flow as a function of hydraulic gradient and the transmission properties of the soil and water. It was found that effective velocity is proportional to hydraulic gradient, all other things being equal:

$$v = Ki$$

where v = effective flow velocity, dimensions $\frac{L}{T}$

(Effective flow velocity is the velocity with respect to the total area of the porous medium--not the void area alone. It may be defined as the quantity of flow per unit of time divided by the total area of the porous medium producing that quantity of flow.)

$$K = \text{a factor, dimensions } \frac{L}{T}$$

i = hydraulic gradient, dimensionless

Thus, hydraulic conductivity is the effective velocity of flow when the hydraulic gradient is unity. In drainage design, it is convenient to express v and K in inches per hour. Darcy's Law is valid for flow velocities in almost any natural drainage situation.

Hydraulic conductivity depends on properties both of the soil and of the transmitted water. A high value is associated with high porosity, coarse open texture, and highly developed structure. Soils do not vary greatly in porosity, but a few large pores are more effective in contributing to high conductivity than many small pores. Fine-textured soils may depend almost entirely on the structural pores for their conductivity. The quality of the water transmitted, particularly the salinity and alkalinity, may have a marked effect on hydraulic conductivity.

Soil within a drainage-problem area seldom has uniform permeability. This variation is exhibited in two important characteristics: the soil may be nonhomogeneous due to stratification, barriers, or other distinct masses; or it may have a higher permeability in one direction than another, even though homogeneous. Soils with this latter quality are called "anisotropic" (see section on "Paths of Flow").

Rate of flow

The rate of flow (Q) passing a given cross-sectional area of saturated soil (A) is the product of the area and the effective velocity of flow through the section (v):

$$Q = Av$$

Combining this expression with the Darcy Law

$$v = Ki$$

we have the expression

$$Q = AKi.$$

This equation may be used to estimate the quantity of flow in simple drainage problems, such as might be found in hillside interception over a sloping, impermeable layer. In more complex flow problems, both the hydraulic gradient and the hydraulic conductivity vary throughout the flow region and analysis is more difficult. Also, the boundaries of flow may be difficult to determine. For these problems, it usually is impractical to define completely the area, permeability, and hydraulic gradient, so less direct methods of estimating flow are employed. These are discussed in Chapter 4, Subsurface Drainage.

Sink formation in subsurface drainage

Subsurface drainage is accomplished by placing below the water table an artificial channel in which the hydraulic head is less than it is in the soil to be drained. Thus a hydraulic gradient toward the channel is induced, and a "sink" is created. The sink is maintained, of course, by removing water from the artificial channel by gravity or by pumping.

Two factors determine the rate at which water moves toward the sink at any point: The hydraulic gradient and the hydraulic conductivity. This is in accord with Darcy's Law. Total flow to the sink involves hydraulic conductivity throughout the whole soil mass through which water moves to the sink. The flow net delineates the extent and pattern of flow throughout this soil mass, as discussed on the preceding pages.

The desired control of the water table is accomplished (a) by locating the sink vertically and horizontally so as to take advantage of the more permeable soil masses, and (b) by controlling the hydraulic gradient. Hydraulic gradient may be controlled through depth of the sink, spacing of the sinks, and (in methods of drainage) the pressure at the sink. In Equation 1-1

$$\text{Hydraulic gradient} = \frac{\left(\frac{P_1}{W} + Z_1\right) - \left(\frac{P_2}{W} + Z_2\right)}{L}$$

these three controls affect Z_2 , L and P_2 , respectively.

Drainage devices that are used to form sinks are buried drains, ditches, relief wells (upward flow), vertical drains (downward flow), and pumped wells. The hydraulic head in buried drains and in ditches depends on the water-surface elevation because the water is at atmospheric pressure. Relief wells, at their lower ends where the sink usually is formed, operate under a pressure dependent on the elevation of their outlets--or of the water surface in the drain into which they discharge, if submerged. Pumped wells create sinks which may be either at atmospheric pressure or above atmospheric pressure, depending on the soil stratification and whether the sink in question is above or below the water level in the pumping well.

Theories of Buried Drain and Open Ditch Subsurface Drainage

Water movement in the saturated zone may be analyzed by applying Darcy's Law to the particular set of boundary conditions at the drainage-problem site. If it were possible by field surveys to determine the exact location of impermeable layers, the location and hydraulic head of all inflow to and outflow from the system, permeability in all parts of the system, time and rate of changes in flow, symmetry of the system--all the factors which affect the amount and pattern of flow--then the problem would be completely defined and subject to direct and exact solution.

Drainage problems are seldom so completely defined in practice, however. Usually they consist of a more or less complex combination of different problems. The procedure is to determine the boundary conditions, first approximately, then in as much detail as necessary by means of the reconnaissance and preliminary surveys. Certain situations or sets of boundary conditions are recognized as problem types for which experience or analysis has given us design criteria. After identification of the problem type, the necessary field measurements and investigations are made so that design criteria may be applied. For some drainage problems, there are few numerical criteria, if any, and the designer relies mostly on good judgment. But in all drainage problems the basic procedure is that previously outlined.

Drainage theories have been developed to describe or to attempt to describe the action of a given saturated flow system. They are useful in getting an approximate solution to actual field problems. To use them, the designer must compare the field situation with the underlying assumptions on which the drainage theories are based. He then applies such of them as his judgment indicates are most applicable. Both steady state and nonsteady state problems are encountered in drainage work. The following approximate theories have been applied to one or both types of problems.

Classification of drainage theories by basic assumptions

Horizontal flow theories

These approximation theories are based on two assumptions: (a) that all streamlines in a gravity flow system are horizontal, and (b) that the velocity along these streamlines is proportional to the slope of the free-water surface, but independent of depth.

Although it can be shown that these are erroneous assumptions, (see "Hydraulic Gradient" page 1-12) the theory of horizontal flow gives sufficiently accurate results if its application is restricted to situations where the flow is largely horizontal. Three field conditions of this kind are:

1. Open ditches that are shallow compared to their spacing and that penetrate to or are close to an impermeable layer.
2. Open ditches that are excavated in stratified materials.
3. Buried drains under conditions 1 and 2, particularly if the backfilled trench is more permeable than the undisturbed material.

One expression of the horizontal flow theory is the ellipse equation, of which the tile-spacing formula developed by Donnan (3) is one form. Application of the ellipse equation is discussed in Chapter 4, Subsurface Drainage.

Visser (4) in another application of the ellipse equation, extended it to apply to nonsteady state problems. His method was developed for conditions in the Netherlands, but according to Van Schilfgarde, Kirkham, and Frevert (5), the method possibly could be applied profitably in irrigated areas of the arid regions.

Radial flow theories

A tile line may be thought of as a horizontal well, with water approaching the tile along radial streamlines. This analogy is the basis for the radial flow theories, which assume (a) a homogeneous isotropic soil of infinite depth, and (b) a flat water table. This method can give a good approximation of actual flow

conditions if the curvature of the water table is small (as with a low rainfall rate and relatively high permeability), and if below the drain there is no layer of greatly reduced permeability.

Combined horizontal and radial flow theories

Hooghoudt (6) and Ernst (7) have developed solutions of the flow problem by combining the radial and horizontal flow hypotheses. These solutions correct the major shortcoming of the ellipse equation (neglect of convergence of flow near the drain). They are valuable and reliable approximations for the steady-state problem of removing steady rain or equivalent accretion.

Hooghoudt modified the ellipse equation by introducing an "equivalent depth," and he prepared extensive tables of the equivalent depth for solution of steady-state problems. Visser (4) reports on a nomographic solution based on the same general assumptions as Hooghoudt's method, and Van Beers (8) has developed nomographs for calculation of drain spacing according to the Hooghoudt and Ernst formulas.

Van Deemter's (9) hodograph analysis

This is a mathematical analysis involving the solution of certain differential equations so as to satisfy the boundary conditions. Van Deemter used this analysis to study tile drainage, but his results apply only to tile running full.

In summary, the approximate solutions obtained by application of these theories are simpler than exact solutions which may be available for some problems, and they provide solutions to other problems for which no other methods are yet known. It is important, however, that the following inherent limitations be recognized so that the method which is most nearly applicable may be applied:

1. Horizontal flow theory (ellipse equation).--Use where the flow is largely horizontal, as for drains shallow compared to their spacing with all impermeable layers at or close to the bottom of the drain.
2. Radial flow theory.--Apply it to homogeneous isotropic soil of great depth, with a flat or nearly flat water table.
3. Combined horizontal and radial theories (as Hooghoudt's).--Use for situations where the impermeable layer is either shallow or deep, by using Hooghoudt's equivalent depth or the nomograph published by Visser.
4. Van Deemter's hodograph analysis.--Apply Van Deemter's analysis only to tile drains running just full, or to problems where the water table stands immediately above the drains.

Transient flow concept

The drainage of irrigated land presents problems which are different from those in humid areas. The rise and fall of the water table in irrigated areas generally follows a cycle which is related to the application of irrigation water during the growing season and the termination of irrigation water use in the off season. Contrasted with the steady-state ground-water conditions in humid areas the storage and discharge of ground water in irrigated areas follows a transient or nonsteady-state regimen. The Bureau of Reclamation has developed a method for drain spacing based on the transient-flow concept which gives consideration to the wide diversity of soils and ground-water conditions prevailing in Western United States. A theoretical formula, which incorporates most of the factors involved, was developed by R. E. Glover, and procedures for use of the formula

were developed by Lee D. Dumm, both engineers for the Bureau of Reclamation (10). The transient-flow concept has been in use by the Bureau for several years, and through experience with its use many refinements have been made (11). Van Beers' (8) nomographs for calculation of drain spacings include one for the Glover/Dumm formula and its use is recommended when using metric units.

Techniques for applying drainage theories

The foregoing are the principal theories of saturated flow toward drains. A number of techniques have been used to apply these and other fundamental approaches to the solution of actual drainage problems.

Mathematical analysis

This method is illustrated by Kirkham's (12) analytical solution of the problem of several tube drains equally spaced above an impermeable layer, using the method of images. For problems involving curved streamlines and stratified soil, this method is lengthy and involved. Laplace's fundamental flow equation, which combines Darcy's Law with the equation for continuity of flow, is the starting point for most mathematical analyses of drainage problems. The application of Laplace's equation is an "exact" method, but its complexity in solving actual problems has led to the approximate theories described in the preceding section.

Relaxation method

The relaxation method is a numerical analysis. It is a simple and powerful tool but usually is tedious to use.

Essentially, the relaxation method is the application of the Laplace equation by trial to points on a plane through the flow system. The boundary conditions must be known. A square grid is oriented conveniently on the plane, and numerical values are assigned to the potential along the boundaries in accordance with the site conditions. At each point of intersection of the grid, arbitrary or estimated numerical values are assigned. Then these numbers are adjusted until the value at each grid point is the arithmetic mean of the four values at the adjacent points.

Stratification, anisotropic conditions, and other variations may be accounted for by appropriate adjustment in the procedure. Luthin and Day (13) have used the method to apply to unsaturated flow. The relaxation method was used to construct the nomographic solution of the combined horizontal and radial flow theories previously described. The method has been applied to both steady- and nonsteady-state problems.

Electrical analog

Laplace's equation is the differential equation for electric potential distribution in conductors. Consequently, electric-model tests of ground-water flow may be based on the analogy between Darcy's Law and Ohm's Law (hence the name "electrical analog"). Conductor paper may be used to represent a plane in the flow region, on the boundaries of which potentials are placed to represent the actual problem boundary conditions.

A vacuum-tube voltmeter is used to measure the potential at various points on the plane, and from these data the flow net may be drawn. Resistance networks have been used in place of the conductor paper, particularly to study the effect of stratified soils on flow into drains.

Models

Sand or soil is sometimes placed in tanks so as to reproduce idealized field conditions for convenient study. The Hele-Shaw channel--Todd (14)--is a model which substitutes the flow of a viscous liquid between closely spaced plates for the flow of water through soil. Models are useful in testing the validity of approximate drainage theories.

Design Criteria

Criteria for design of drainage systems are essentially the specifications for conditions which must exist in a particular area for it to have the optimum level of water control required by the kind of agriculture to be practiced. These criteria consist of two items: (a) the rate of water removal necessary to provide a certain degree of crop protection, and (b) the optimum depth to water table.

The rate of water removal, often referred to as the drainage coefficient, may be expressed as a certain depth of water to be removed from the watershed per day, or as a rate of flow per unit of area, as cubic feet per second per square mile. For consideration of precipitation and runoff characteristics, the rate of removal should be based on a curve which varies according to the size of the drainage area.

Optimum depth to water table is that depth required for best plant-soil-water-air relationship, and which is feasible to maintain under existing conditions. A certain tolerance is necessary since it is not possible to maintain a particular depth exactly.

Several factors must be considered in selection of design criteria for a particular project. These include the requirements of crops to be grown as related to water needs and tolerance to excess water, soils, climate, salinity in the soil or in irrigation water, and economics. Within a particular watershed the criteria may be determined by a detailed analysis of all factors involved or by use of empirical methods based on experience with similar problems and consideration of the physical data available.

Drainage Coefficients

Criteria for design of drainage disposal systems by the Soil Conservation Service is based largely on empirical methods. Formulas for rates of removal have been used in the United States for over 50 years and have been refined by experience and gaged data. When planning drainage improvements in the Cypress Creek Drainage District, Desha and Chicot Counties, Arkansas, 1911-15, S. H. McCrory and Associates (15) developed a formula for determining the rate of runoff for drainage design. This formula now known as the Cypress Creek Formula, may be expressed as follows:

$$Q = 35M^{5/6}$$

where Q = rate of runoff at any point in the system from the drainage area above the point - in cubic feet per second.

M = drainage area in square miles.

The coefficient 35 was based on gaged runoff from different parts of the watershed, and consideration of the probable effect that drainage improvements would have on the rate of runoff.

Drainage systems have been installed on millions of acres of land in the alluvial valley of the Mississippi River by use of the Cypress Creek Formula, and slight modifications of it, and its validity has been proven by the successful functioning of these systems. By substituting a variable coefficient, C, for the 35 in the formula, and selecting a value for the coefficient based on the characteristics of a particular watershed and the degree of protection desired, the formula can be used for computing surface drainage removal rates in most of the United States.

The selection of a drainage coefficient, or the rate of water removal, for a particular drainage system, should be based on the water tolerance of crops to be grown and the physical characteristics of the area. Climate, soils, topography and crops are always important factors to consider. Where irrigation is practiced the quantity and quality of the irrigation water and irrigation water management practices also must be considered.

Research by Stephens and Mills (16) has resulted in a way to relate the coefficient in the Cypress Creek Formula to the particular characteristics of a watershed and the level of protection justified. This is discussed in Chapter 5 of this Handbook.

Drainage coefficients for surface drainage

A drainage coefficient for a surface drainage system should consider the characteristics of precipitation in the area as well as other climatic factors, topography, crop tolerance to excess water, soils, and irrigation. Stream gage records and studies made of the flow of excess precipitation from flatland watersheds indicate that the rate of flow per unit of area decreases as the total contributing area increases. The rate of change, as indicated by the exponent of M in the Cypress Creek Formula, varies somewhat between watersheds and with the intensity and duration of a particular storm. However, analysis of considerable stream gage data and experience with use of the Cypress Creek Formula support the $5/6$ exponent used in it for flatland watersheds. The procedure developed by Stephens and Mills for relating the coefficient in the Cypress Creek Formula to the characteristics of a watershed and the level of protection desired can be used to develop curves for rapid determination of runoff from areas with certain characteristics and for the required level of protection for specified cropping patterns.

Drainage coefficients for subsurface drainage

Whether the excess water results from precipitation, excess irrigation water, leaching water or ground-water flow from outside the area the flow into subsurface drains is more uniform and extends for longer periods of time than does the flow into surface drains. A drainage coefficient for subsurface drainage is related to the source of the excess water, to the rate of flow of the excess water through the soil, and to the tolerance of crops in the cropping system to excess water.

As the rate of flow through the soil is slower than overland and extends over a longer period of time, drainage coefficients for subsurface drainage are usually much smaller than for surface drainage. They are usually specified as a depth of water to be removed in 24 hours or one day. In humid areas the rate of removal specified is usually uniform for large areas, but in arid and semiarid irrigated areas the rate of flow per unit of area decreases as the size of the area increases because of the rotation of irrigation within large project areas and non-uniformity of other sources of excess water.

Drainage coefficients for pumping plants

Drainage coefficients for pumping plants are based on the criteria used for design of the drainage system which delivers water to them. Characteristics of flow to the pumping plant, whether surface, subsurface, or both, should be considered in determining the pumping capacity of the pumps. Most pumping plants are designed with a certain amount of storage in the forebay of pumps, which should be considered in relating the flow from the contributing area to the pumping capacity required. Surface drainage systems usually have substantial storage capacity below the elevation which will result in crop damage and which can be utilized to reduce the pumping capacity required (17). The flow from subsurface systems is much more uniform and less forebay storage is needed.

Drainage coefficients for watershed protection

Watershed-protection plans should be developed to create good conditions for plant growth, including protection against excess surface water and control of soil-moisture content. To assure these conditions, all multiple-purpose or flood-prevention channels, into which lands requiring drainage must outlet, should have capacities no less than those based on the applicable drainage coefficients. Where lands requiring drainage are planned for protection by flood-water-retarding structures and channels, the channel system should provide no less protection than that established by the drainage coefficient. Such a design requires that the entire watershed area be taken into account. Flow from flood-water-retarding structures should be added to the flow from unprotected uplands and flood-plain lands which is based on appropriate drainage coefficients for such unprotected land.

Special requirements for flatland

In considering the runoff from flatlands requiring drainage systems, it is important to consider the influence of extensive surface-drainage systems on the required capacity of the main ditches. Flatlands may have a large amount of surface storage in shallow depressions and a low rate of runoff before installation of water collection and disposal systems. As drainage collection and disposal systems are installed, both surface storage and time of concentration decrease. The long-range trend of agricultural development needs to be studied in determining the coefficients applicable to main drainage ditches for extensive areas of flatland.

Depth to water table

Optimum depth to water table is the subject of considerable research in the United States; and also in the Netherlands, where water tables can be controlled within close limits throughout the growing season in much of the country (18). One of the main factors involved is the quality of water. If it is free from salts, indications are that the water table needs to be only as deep as required to provide sufficient root zone depth for support of plants to be grown and to support tillage equipment. As roots generally do not penetrate deeper than approximately one foot above the water table the depth to water table should be approximately one foot more than the depth of the root penetration desired. Where salts are present the water table must be deep enough to prevent capillary flow from bringing dissolved salts up into the root zone.

Pumped-Well Drainage

Pumped wells have effectively drained land in some locations. Though costly and restricted to favorable geologic conditions, pumped wells are versatile and may have an economic advantage over other methods of lowering and maintaining a desirable water-table level.

Pumped-well drainage is based on the following principles:

1. A pumped well, like other forms of artificial drainage, increases the flow energy gradient by creating a sink within a saturated zone.
2. Energy which the well makes available to the ground-water flow system is derived from the motor which lifts the water from the sink.
3. The increased gradient must extend to the crop-root zone in such degree as to control the water table within the desired area and to the desired level.
4. The increased energy gradient may be in the form of drawdown; i.e. water table slope toward the well; or it may be in the form of a pressure gradient where the ground water is confined. In either case, at a given point in the saturated zone, the quantity (P_2) is decreased in the expression:

$$\text{Hydraulic gradient} = \frac{\left(\frac{P_1}{W} + Z_1\right) - \left(\frac{P_2}{W} + Z_2\right)}{L} \quad (\text{Eq. 1-1})$$

thus increasing the gradient toward the well. See "Hydraulic head" and "Hydraulic gradient" pages 1-10 to 1-14.

Classes of pumped wells

Water-table wells

Water-table wells remove water directly from the free ground water, creating a drawdown surface in the water table.

Confined-aquifer or artesian wells

These wells remove water from a fully saturated aquifer which is confined by impermeable or slowly permeable layers.

Theories of flow into pumped wells

Flow into wells is a function of the drawdown, and usually is expressed in the general form:

$$Q = f(y_1, y_2, r_1, r_2)$$

where y_1 and y_2 are the depths of water (or hydraulic head) at distances r_1 and r_2 from the well, respectively.

Water-table wells

The approximations of Dupuit are the basis for the equation:

$$Q = \pi K \frac{y_2^2 - y_1^2}{\log_e (r_2/r_1)}$$

where Q = flow into well, with dimensions L^3/T

K = hydraulic conductivity, L/T

y_1, y_2, r_1, r_2 as previously defined, in units of L

(L = length and T = time)

This equation neglects the curvilinear flow due to the drawdown shape. The error is not large if r_1 and r_2 are sufficiently large so that the curvature is negligible. The equation may be used to predict the draw-down curve and radius of effective influence. It is useful also for computing the hydraulic conductivity from field-pumping tests. Two or more observation wells are installed at different distances from the pumped well. The nearest observation well should not be closer to the pumped well than 100 times the well radius.

Confined-aquifer or artesian wells

Corresponding to the equation for unconfined aquifers, the Dupuit equation for confined aquifers becomes:

$$Q = 2\pi Km \frac{y_2 - y_1}{\log_e (r_2/r_1)}$$

where Q = flow into well, with dimensions L^3/T

K = hydraulic conductivity, L/T

m = thickness of aquifer, in units of L

y_1 and y_2 = depth from bottom of aquifer to pressure surface, at distances r_1 and r_2 from the well, respectively, all in units of L .

Additional information on the hydraulics of wells may be obtained from NEH, Section 18, Ground Water, pp 1-12 to 1-18.

Basis for design of pumped-drainage wells

The above equations are for the equilibrium or steady-state condition. Similar relations have been derived for use in the nonsteady state, such as in situations where pumped wells continue to deplete stored water.

Pumping from confined aquifers usually is steady throughout the season because the aquifers are deep and replenish slowly and uniformly. But water-table wells may be used for either short-time drawdown or near-constant seasonal discharge. Therefore, their design should be based on two considerations:

1. Capacity should be sufficient to lower the water table after irrigation, heavy precipitation, or other influent seepage, in a relatively short time to avoid crop damage.
2. Capacity should be sufficient to remove at least the seasonal net replenishment, which is the ground-water replenishment less depletions from causes other than the pumped well in question. Shorter pumping periods may be required for this analysis, such as 1-, 2-, or 3-month periods.

Advantages of pumped-well drainage

A high initial and operating cost for a pumped well for land drainage may be offset by a number of its advantages over a shallow drain system. Some of these are:

1. The water table may be lowered to much greater depths.
2. Deep strata may be much more permeable than those nearer the surface.

3. Productive land which would be occupied by open drains is saved.
4. Maintenance costs are less than for open drains and may be less than for closed drains.
5. Pumped water may be a valuable supplement to the irrigation-water supply.

References

- (1) DARCY, H.
1856. Les Fontaines Publiques de la Ville de Dijon, Paris.
- (2) WILLIAMSON, R. E. and KRIZ, GEORGE J.
1970. Response of Agricultural Crops to Flooding, Depth of Water Table and Soil Gaseous Composition, Transactions of the American Society of Agricultural Engineers, Vol. 13, No. 2 pp. 216-220.
- (3) DONNAN, W. W., BRADSHAW, G. B., and BLANEY, H. F.
1954. Drainage Investigation in Imperial Valley, A 10-Year Summary. U. S. Dept. Agr., SCS-TP-120.
- (4) VISSER, W. C.
1953. De Grondslagen van de Drainageberekening. Landbouwk. Tijdschr. 65: 66-81.
- (5) VAN SCHILFGAARDE, J., KIRKHAM, D., and FREVERT, P. K.
1956. Physical and Mathematical Theories of Tile and Ditch Drainage and Their Usefulness in Design. Iowa Agr. Expt. Sta. Res. Bul. 436. 667-706.
- (6) HOOGHOUTD, S. B.
1940. Bijdragen tot de Kennis van Eenige Natuurkundige Grootheden van den Grond, 7, Algemeene Beschouwing van het Probleem van de Detail Ontwatering en de Infiltratie door Middel van Parallel Loopende Drains, Greppels, Slooten en Kanalen. Versl. Landbouwk. Ond. 46: 515-707. Algemeene Landsdrukkerij, The Hague.
- (7) ERNST, L. F.
1954. Het Berekenen van Stationaire Groundwaterstromingen, Welke in een Vertikaal Vlak Afgebeeld Kunnen Worden, Rapport Bodemk. Inst. T.N.O., Groningen.
- (8) VAN BEERS, W. F. J.
1965. Some Nomographs for the Calculation of Drain Spacings. International Institute for Land Reclamation and Improvement, Wageningen, the Netherlands, Bulletin 8.
- (9) VAN DEEMTER, J. J.
1950. Bijdragen tot de Kennis van Enige Natuurkundige Grootheden van de Grond, 11, Theoretische en Numerieke Behandeling van Ontwatering- en Infiltratiestromingsproblemen. Versl. Landbouwk. Ond. 56, Nr. 7. Staatsdrukkerij, The Hague.
- (10) DUMM, LEE D.
1954. Drain Spacing Formula. Agricultural Engineering, Vol. 35, No. 10, pp 726-730.
- (11) DUMM, LEE D.
1964. Transient-Flow Concept in Subsurface Drainage: Its Validity and Use. Transactions of the American Society of Agricultural Engineers, Volume 7, No. 2, pp 142-146, 151.

- (12) KIRKHAM, D.
1949. Flow of Ponded Water into Drain Tubes in Soil Overlying an Impervious Layer. Am. Geophys. Union Trans. 30: 369-385.
- (13) LUTHIN, J. N., and DAY, P. R.
1955. Lateral Flow above a Sloping Water Table. Soil Sci. Soc. Am. Proc. 19: 406-410.
- (14) TODD, D. K.
1955. Flow in Porous Media Studied by Hele-Shaw Channel. Civ. Engr. 25: 51.
- (15) McCRORY, S. H., BAXTER, O. G., YARNELL, D. L., JONES, L. A., and SCHLICK, W. J.
1915. Report upon the Cypress Creek Drainage District, Desha and Chicot Counties, Arkansas. U. S. Dept. Agr., Office of Exper. Sta., Bul. 198.
- (16) STEPHENS, JOHN C. and MILLS, W. C.
1965. Using the Cypress Creek Formula to Estimate Runoff Rates in the Southern Coastal Plain and Adjacent Flatwoods Land Resource Areas. U. S. Dept. Agr., ARS-41-95.
- (17) SUTTON, JOHN G.
1950. Design and Operation of Drainage Pumping Plants. U. S. Dept. Agr. Tech. Bul. 1008, p. 34.
- (18) WESSELING, J. and VAN WIJK, W. R.
1957. Height of Water Table. Drainage of Agricultural Lands. Vol. VII of Agronomy Monographs, pp 498-503, American Society of Agronomy. Madison, Wisconsin.

UNITED STATES DEPARTMENT OF AGRICULTURE

SOIL CONSERVATION SERVICE

NATIONAL ENGINEERING HANDBOOK

SECTION 16

DRAINAGE OF AGRICULTURAL LAND

CHAPTER 2. DRAINAGE INVESTIGATIONS

| | <u>Contents</u> | <u>Page</u> |
|--|-----------------|-------------|
| General | | 2-1 |
| Existing data | | 2-1 |
| Aerial photographs | | 2-1 |
| Maps | | 2-1 |
| Surveys | | 2-1 |
| Miscellaneous data | | 2-2 |
| Soil Conservation Service experience in particular areas | | 2-2 |
| Relation of flood hazard to drainage feasibility | | 2-3 |
| Adequacy of outlet for drainage improvement | | 2-3 |
| Basic requirements | | 2-4 |
| Special outlet conditions | | 2-4 |
| Tidal influence | | 2-4 |
| Pumping | | 2-4 |
| Dikes and floodgates | | 2-5 |
| Economics of drainage projects | | 2-5 |
| Classification of Investigations | | 2-5 |
| Reconnaissance | | 2-5 |
| Field reconnaissance | | 2-5 |
| Detailed reconnaissance | | 2-6 |
| Objectives | | 2-6 |
| Recommended procedure | | 2-7 |
| Preliminary Survey | | 2-8 |
| Objectives | | 2-8 |
| Recommended procedure for preparation of survey outline | | 2-8 |
| Preliminary design and estimate | | 2-9 |
| Preparation of plans and estimates | | 2-10 |
| Design Survey | | 2-11 |
| General | | 2-11 |
| Data required for design | | 2-12 |
| Investigations for Surface Drainage | | 2-13 |
| General | | 2-13 |
| Vertical Control | | 2-13 |
| Topography | | 2-14 |
| Soils investigations | | 2-15 |

| | |
|--|------|
| Soil classification | 2-15 |
| Soil surveys | 2-15 |
| Investigations for channel stability | 2-15 |
| Land use and cropping pattern | 2-16 |
| Precipitation, runoff, and stream stage records | 2-16 |
| Location of mains and laterals | 2-16 |
| Profiles and cross sections | 2-17 |
| Recommendations for additional information and construction requirements | 2-18 |
| Investigations for Subsurface Drainage | 2-18 |
| General | 2-19 |
| Surveys and investigations required | 2-19 |
| Topographic surveys | 2-20 |
| Soils investigations | 2-21 |
| Subsurface explorations | 2-21 |
| Logging soils and subsurface materials | 2-22 |
| Soil samples for laboratory testing | 2-24 |
| Hydraulic conductivity | 2-27 |
| Auger-hole method | 2-28 |
| Equipment for auger-hole method | 2-29 |
| Formulas for determination of HC by auger-hole method | 2-33 |
| Other methods for determining hydraulic conductivity | 2-34 |
| Ground-water investigations | 2-34 |
| Observation wells | 2-34 |
| Size of wells and casing | 2-34 |
| Spacing | 2-37 |
| Depth | 2-37 |
| Establishing well elevations | 2-37 |
| Measuring water table levels and recording data | 2-37 |
| Period of measurement | 2-39 |
| Piezometers | 2-39 |
| Installation by driving | 2-43 |
| Installation by jetting | 2-43 |
| Batteries of piezometers | 2-45 |
| Salinity of ground water | 2-45 |
| Irrigation practices | 2-45 |
| Investigation of existing systems of buried drains | 2-45 |
| References | 2-47 |

Figures

| | | |
|------------|---|--------|
| Figure 2-1 | Sample form for soil log | 2-23 |
| Figure 2-2 | Check list for fine-grained and partly organic soils | 2-25 |
| Figure 2-3 | Check list for coarse-grained soils | 2-26 |
| Figure 2-4 | Symbols for auger-hole method of measuring hydraulic conductivity | 2-28 |
| Figure 2-5 | Equipment for auger-hole method of measuring hydraulic conductivity | 2-30 |
| Figure 2-6 | Auger-hole method of measuring hydraulic conductivity | 2-31 |
| | | & 2-32 |
| Figure 2-7 | Hydraulic conductivity--auger-hole method by Ernst Formula | 2-35 |
| | | & 2-36 |

| | | |
|-------------|---|--------|
| Figure 2-8 | Example of field sheets for well and piezometer records | 2-38 |
| Figure 2-9 | Max-min well gage | 2-40 |
| | | & 2-41 |
| Figure 2-10 | Example of field sheet for piezometer log | 2-44 |

Appendix A

| | |
|--|------|
| Typical Outline for Preliminary Survey (Following page 2-48) | 2A-1 |
|--|------|

NATIONAL ENGINEERING HANDBOOK

SECTION 16

DRAINAGE OF AGRICULTURAL LAND

CHAPTER 2. DRAINAGE INVESTIGATIONS

General

Drainage projects require survey and investigation of site conditions and study of historical data to determine their feasibility and for design. The extent of investigation required for each project depends on the investigator's experience in the area and the amount of data already available. Where the project is small and problems and their solutions are obvious, investigations and surveys may be limited to field checking at the site. Larger or complex projects will require more intensive investigations.

This chapter provides guidelines for determination of the extent of investigations needed under various conditions and describes procedures for making them.

Existing data

Use of existing data, such as maps, plans, and records, and the experience of trained personnel saves considerable time in the investigation of drainage projects. Available data relating to local drainage problems should be obtained, evaluated, properly identified, and assembled for use. Local SCS personnel should become familiar with these data in order to make the maximum use of it. Some types of data helpful to drainage work, and which should be available locally, are discussed below. The source of supply of the data is indicated.

Aerial photographs

Standard 4- and 8-inch per mile prints are usually available through the local SCS work unit. The more up-to-date they are the more useful they will be. Mosaics may be needed on larger projects. Photos in USDA-SCS county soil survey reports, particularly in those recently published, are valuable aids.

Maps

Maps which show detailed and recent topographic data are the most valuable. Quadrangle maps of the U. S. Geological Survey (USGS), Corps of Engineers (CE), Bureau of Reclamation, Tennessee Valley Authority, or other federal or state agency may be available. Local irrigation or drainage districts or private engineering firms often have useful maps which may be obtained. USGS maps are available from the U. S. Geological Survey, Denver, Colorado or Washington, D. C. CE maps are available from the District Engineer of the District which made the map. An index of maps is available from the USGS.

Surveys

Old drainage surveys and maps are often available and generally contain useful information. These are usually available through the drainage district, county clerk or county engineer.

Soil, geologic, ground water, and topographic surveys are helpful in drainage work. Benchmark surveys made by the U. S. Coast and Geodetic Survey, USGS, Corps of Engineers, Bureau of Reclamation or other federal or state agency are valuable. Vertical control for large group or district enterprises should be tied to standard benchmarks, based on mean sea level datum wherever practicable.

Miscellaneous data

Records and reports of value may include: reports of surveys listed above; soil conservation district programs and work plans; standard soil survey reports; precipitation, streamflow, river stage, and tidal records; and crop yield data.

The following publications will be of particular interest:

1. "Rainfall Frequency Atlas of the United States" - U. S. Department of Commerce, Weather Bureau - Technical Paper No. 40, May 1961, and Technical Paper No. 43, 1962 for Hawaii.
2. Two- to Ten-Day Precipitation for Return Periods of 2 to 100 years, U. S. Department of Commerce, Weather Bureau, Technical Paper No. 49, 1964 for the contiguous United States, Technical Paper No. 51, 1965, for Hawaii, and special precipitation records for mountain states.
3. Location of hydrologic stations, including those measuring precipitation, and river gaging stations are shown in "Notes on Hydrologic Activities Bulletin No. 11" compiled under the auspices of the Inter-Agency Committee on Water Resources, Subcommittee on Hydrology, April 1961. This is available through the National Weather Service.
4. Tide Tables, compiled by the U. S. Coast and Geodetic Survey, are available from that agency's Washington office. The volume for the Atlantic and Gulf Coast is "Tide Tables, East Coast, North and South America (including Greenland)" and for the Pacific Coast, "Tide Tables, West Coast, North and South America (including Hawaiian Islands)." These are published annually.
5. Data on benchmarks established by federal agencies are available on request from their local district headquarters or the Washington office. Requests should specify the locality for which the information is desired.
6. State Laws - requirements of state agencies for project development, clearance, etc. should be known.

All data should be evaluated for currency, accuracy, and application to the problem area, and it should be identified as to source and date of procurement. Also, after evaluation, the results of the evaluation should be clearly stated, dated, and signed by the evaluator. Limitations on use of the data should be specified.

Soil Conservation Service experience in particular areas

To take advantage of experience gained by working in a particular area use the SCS "Drainage Guides" which describe problems of drainage on certain soils within particular areas, investigations required, and the general criteria for design of remedial measures.

Before the different kinds of problems encountered in agricultural drainage are recognized, a good knowledge of soils, hydrology, hydraulics, and agricultural economics is needed. The effects of excess water and salinity on plant growth must be understood. Types of problems encountered in drainage work and principles of dealing with them are discussed in Chapter 1. Details of remedial measures are in other chapters which cover the particular type of drainage.

Relation of flood hazard to drainage feasibility

When investigating drainage problems it is important to determine if the area is subject to flooding and the frequency and character of the flooding. Floods may be so frequent and damaging that, without their prevention, drainage of the project area would not be feasible.

The principle of drainage design is to remove excess water from the surface of the land and/or from the root zone of the crop, before it causes damage, and to create a more favorable environment for the desired crops. There are periods in the growth of some crops when flooding should be held to as short a time as possible, but it is usually not feasible to attempt to contain all runoff from the less frequent rainfall events within ditch banks without any overland flow.

In evaluating the effects of flooding on flatland areas the following factors should be considered:

1. Frequency of damaging floods.--The frequency of damaging floods under which agricultural land can be operated profitably will vary according to the kind of crops to be grown, productivity of the land, the cost of preventing such floods, and other economic factors. If damaging floods can be expected more often than once each 3 to 5 years an economic evaluation for determining feasibility of the project may be required.
2. Depth and duration of flooding.--Flooding to shallow depths for a short duration may not be damaging. In many areas it has been determined that water standing 6 inches deep for periods up to 24 hours usually is not damaging to field crops. Truck crops and other crops sensitive to excess water usually require a more rapid rate of water removal. Most pasture, and riceland in rotation with pasture, can withstand longer periods of flooding without damage.
3. Time of flooding.--During the season when crops are not being grown, damage by flooding on flatland may be limited to scour of the flood plain, deposition of sterile materials, and/or property damage. Under some conditions floods may benefit land by deposition of topsoil and nutrients.
4. Erosion and/or sedimentation.--If flooding in a particular area is likely to cause serious erosion, the feasibility of drainage improvement is questionable. If sedimentation is excessive, methods to control it should be investigated. Such measures as diversions, dikes, and debris basins may be indicated. Flood plain scour or excessive sedimentation expected may make the project feasibility questionable.

Adequacy of outlet for drainage improvement

Drainage improvements should be continued to an adequate outlet. Generally, improvements to a drainage system will increase the peak discharge for the more frequently recurring storms. The increase will vary according to the ratio of ditch capacities after improvement to their capacities before improvement. The effect which this increase in peak discharge has on stages of water in the outlet depends on the relation of the size, shape, and hydrologic factors of the project area improved to the size, shape, and hydrologic factors of the watershed of the outlet above the point of discharge of the project system.

Effects of drainage improvements on water stages in outlets consisting of major rivers, large lakes, or tidewater may be considered negligible. Effects on outlets in flat lands, whose drainage area above the point of discharge of the project system is at least ten times the size of the project drainage area, also may be considered negligible.

Basic requirements

In determining adequacy of outlets the following basic requirements should be met:

1. The capacity of the outlet should be such that the design flow from the project will discharge at a stage elevation equal to or less than that required for adequate drainage of the land in the project. Where the project discharges into a natural or constructed channel, consideration should be given to the runoff from the entire watershed of the channel, which should be computed on the same basis as that used for the project area. The stage-discharge relationship of the outlet channel should be determined from records or by calculation.
2. The capacity of the outlet also must be such that the discharge from the project, after proposed improvements, will not result in stage increases in the outlet that will cause significant damages downstream.
3. The elevation of the water surface at normal low flow in the outlet should permit any needed subsurface drainage to be discharged.

The hydraulic gradeline for low water flow, from the outlet through the system of mains and laterals to the uppermost subsurface drain in the project, should be determined to insure that all needed drains can be discharged above it.

4. There should not be excessive scour or deposition of sediment in the outlet.

Special outlet conditions

Tidal influence. - Effect of the tides or littoral drift on discharge should be determined where improved channels discharge into rivers, estuaries, bays, and sounds subject to tidal influence. This should apply whether or not the outlet is reached through an automatic tide gate, or directly, without the benefit of a tide gate.

The characteristics and types of tides are discussed by H. A. Marmer in "Tidal Datum Planes," (1), and in Chapter 9 of this handbook. Where the drainage of agricultural land is affected adversely by tidal action it should be protected by a system of dikes and tide gates. Planning, design, and construction of dikes is covered in Chapter 6. Routing of specified flows through existing or proposed gates, in order to determine stage relations in the project area is covered in SCS Technical Release No. 1, "Routing Through Tide Gates," and in Chapter 9 of this handbook.

Pumping. - Where the project is provided with pumps for discharge of runoff from the watershed, the area usually is protected by dikes. In this case the dikes should meet the National Engineering Standard for dikes, the pumping capacity should be adequate for the design runoff, and the outlet into which the pumps discharge should meet the basic requirements for outlets.

Dikes and floodgates. - The area to be improved may be protected from flooding only by a system of dikes and floodgates. In such cases there is a question as to whether a pumping plant is needed to relieve temporary flooding within the protected area during periods when the floodgates are closed due to higher stages on the outside. This resolves itself into a check of coincidence of stages on both sides of the dike. A temporary reservoir is formed in the protected area, and a check is made of the frequency and duration of pumping required to remove water from the reservoir. The cost of the pumping plant required to relieve the temporary flooding within the protected area should be determined, including the cost of operation. This would be compared with the damage which could be expected due to flooding without the pumping plant. A study of the timing of coincident flood stages on both sides of the dike and the economic factors involved will provide the information needed to determine the feasibility of the pumping plant.

Economics of drainage projects

In all cases, recommended improvements should provide benefits in excess of costs. For large complex projects an economic analysis is needed to make the feasibility determination. For small jobs a comparison with similar work in the area, where benefits are well known, is usually enough to determine feasibility.

On large group enterprises, the analysis may be complex and require the assistance of an economist. There are various stages between these two extremes and the principles of good economic analysis should be followed. Reference should be made to the Soil Conservation Service's "Economics Guide for Watershed Protection and Flood Prevention," March 1964.

Classification of Investigations

Investigations for drainage work may be divided into three types depending upon the objectives and level of investigation required. These will be discussed here as:

1. Reconnaissance
2. Preliminary survey
3. Design survey

Since most jobs are somewhat different the investigations needed for each should be considered carefully. For the larger, more complex jobs a work outline usually is required to insure that the data needed is obtained in an orderly manner. Investigations for the smaller, frequently recurring types of jobs may be based on a standard procedure, which has been developed for the particular type of job and a similar set of site conditions. In any case, extraneous details and work not needed to meet a specific objective should be omitted.

Reconnaissance (Preliminary Investigation)

Field reconnaissance

A field reconnaissance of the drainage problem area is necessary to obtain as much information as possible, and to provide the basis for development of a work outline for additional investigations needed. The reconnaissance is usually an inspection of the area from easily accessible points. Parts of the watershed outside the drainage problem area, should be examined to determine runoff characteristics and land treatment needed for protection of the proposed

improvements. This reconnaissance may be supplemented by discussions with the owners and others who are familiar with the area.

For group enterprises where a report is necessary as a basis for determining feasibility of the job, group interest, and determination of SCS personnel time required to complete the job, a more comprehensive reconnaissance is needed. Under these circumstances the type of investigation usually required is on the order of that described as "Preliminary Investigation" in the Watershed Protection Handbook and as a detailed reconnaissance below.

Detailed reconnaissance

This is a streamlined type of investigation to determine the problems in the drainage area and the principal improvements needed, and to make a rough estimate of the cost.

Conditions applicable to a detailed reconnaissance are:

1. A P.L. 566 Watershed which it is known will be considered for planning priority by the Governor of a State or his designated state agency.
2. A group enterprise where the group is not well organized, interest level among some landowners is high, but some opposition may exist, and there is a need for a plan and cost estimate of the project before organization of the group can be completed.
3. A comparatively large and complex individual farm job where the owner needs an estimate of cost before he can commit himself to proceeding with the project.

Objectives

The objectives of a detailed reconnaissance should be to:

1. Determine the extent of the area needing improvement.
 - a. Type of improvements required should be determined: flood prevention, surface drainage, subsurface drainage.
2. Determine the adequacy of outlets for the needed improvements.
3. Develop a general plan for improvement:
 - a. Make an estimate of principal improvements needed.
 - b. If drainage ditches may be located through hardwood swamps, have forester to identify and evaluate timber in a general way.
 - c. Consider wildlife aspects of ditches through swamps. Priorities in maintenance of wildlife values and agricultural purposes should be determined at this stage.
 - d. Determine adequacy of organization to obtain needed rights-of-way. (For group enterprises only.)
4. Insure that the plan of improvement will meet the requirements of state law.

5. Make an estimate of the costs and benefits of the proposed improvements (where necessary).
6. Make a comparison of the costs and benefits and prepare recommendations to the members of the enterprise for the course of action to follow.

Recommended procedure

The following items are considered to be the minimum required. Modification may be needed for the project under consideration.

1. Assemble and evaluate existing data.
2. Prepare a work map of the project showing watershed boundaries, existing streams, old ditches and drains, physical features, and other pertinent information.
3. Obtain or develop a generalized soil and simple land use map of the project.
4. Determine status of any state, federal, or local program which will have an effect on the project.
5. Make an engineering reconnaissance of the project. Observe existing drains and ditches, bridges, topographic and farm conditions, and ground water levels.
6. Determine the adequacy of outlets for drainage improvements.
7. Make the following determinations by evaluating the information gained from the engineering reconnaissance, and the material listed in items 1, 2 and 3 above:
 - a. Develop a tentative plan of improvement.
 - b. Determine the approximate locations of the mains and principal laterals - evaluate adequacy of present locations.
 - c. Prepare cost estimate - consider clearing, excavation, spreading of spoil, erosion control, bridges, culverts and other structures, pipelines, etc.
 - (1) Mains and principal laterals.
 - (2) Minor lateral ditches and drains.
 - (3) Dikes, flood gates, pumping plant.
 - (4) Land, easements and rights-of-way.
8. Check the project cost estimate against costs for similar projects previously constructed. Modify unit costs to represent current costs. Allow for physical differences between projects.
9. Use an adequate contingency allowance in arriving at total cost estimate.
10. Estimate the benefits expected to accrue to the project after installation of proposed improvements. Compare the costs and benefits.

11. Prepare recommendations.

All data developed in the reconnaissance should be plotted on standard data sheets, properly identified and filed in a manner that it can be used most effectively in further work on the project.

Preliminary Survey (Engineering Survey for Watershed Work Plan Investigations and Analysis)

This is a rather comprehensive survey, but lacking the detail required for preparation of construction plans. However, field data collected and recorded should be sufficiently accurate for use in design survey. Extensive field surveys and investigations are made, problems are located and remedial measures are planned, preliminary designs are made, and a reliable cost estimate is prepared. Ordinarily an economic evaluation of project feasibility is made. This type of survey should be made only after it is determined that interest of landowners is adequate to justify the surveys and that it is their intent to assume their financial obligations and overcome any minor obstacles and right-of-way problems.

Preliminary surveys are applicable to:

1. A group enterprise where the drainage problems are complex, the specific measures needed to correct the problems may not be readily apparent, a plan and cost estimate is needed to make arrangements for installation of the needed improvements, and an economic evaluation is needed to determine project feasibility. This includes P.L. 566 Watersheds and RC&D projects.
2. A group enterprise where kinds of needed improvements are known, landowners responsibilities for obligations are known and accepted, but a more detailed survey is necessary for bond issue or for federal assistance.

Objectives

The objectives of a preliminary survey are to:

1. Specifically locate areas in need of improvement - flood prevention, surface drainage, subsurface drainage.
2. Develop a comprehensive plan for improvement based on needs of the watershed and desires of the owners.
 - a. Select design criteria.
 - b. Locate and make preliminary design of all the principal features of the planned improvements.
3. Prepare estimate of quantities and costs.

Recommended procedure for preparation of survey outline

The specific surveys and investigations required to meet the objectives will vary according to the nature of the problems in the area. The procedure outlined below may be altered to meet the particular requirements.

In the preliminary survey, substantial field work is required, the results of which are then evaluated for completeness and accuracy, and data is plotted for use in design. A schedule of operations should be developed to insure that the various phases of the survey are completed as required. In projects where subsurface drainage is a problem it may be necessary to provide a time lag of several months for assembly of field data - other than the periodic reading of observation wells and/or piezometers after their installation and during the period when water table conditions are expected to be most significant.

After the reconnaissance of the project area by the engineer responsible for the survey, made with local personnel most familiar with the situation, the following procedure is indicated:

1. Existing data, pertinent to the problem area, should be obtained. Most of this will have been obtained during the reconnaissance. Careful evaluation of such data will usually save a lot of field work.
2. A survey outline should be prepared. This outline should cover the following items with respect to the specific needs of the area:
 - a. Objectives of the survey and investigation.
 - b. Inventory of available data which will be useful.
 - c. Additional data needed to meet the objectives.
 - d. Proposed plan of investigation.
 - (1) This may need to be expanded or revised as the survey progresses and requirements of the project are better known.
 - (2) The plan of investigation should be carefully worked out to use available routes of communication to the maximum extent possible and to obtain the essential information at the least cost.
 - e. Plan for evaluation of data and preliminary design.
 - f. Preparation of estimates and report.
 - g. Estimate of personnel required - unless the job is to be contracted.
 - (1) A deadline for completion of the survey should be established and types of personnel and time on the job scheduled in order to meet the deadline.
 - h. Equipment required - type and time on job - unless job is to be contracted.

A sample outline for a Preliminary Survey is given in Appendix A. This outline suggests procedures which are of the intensity normally needed for meeting the objectives of this type of survey. As work progresses it may be found that certain changes in the proposed investigations should be made in order to accomplish the objectives at the least cost. Changes in the outline should be made in the same manner as the original outline was developed.

Preliminary design and estimate

The preliminary design required as an essential part of this survey is based on

criteria contained in the chapter of this handbook which deals with the particular type of drainage. State engineering standards and local drainage guides for the practice should be followed. The data on which the design is based will not be of the intensity required for construction design and the design itself need not go into the detail required for construction. The need here is to obtain a design of the project which will permit the development of a cost estimate that will be within the required degree of accuracy. This is generally considered to be an estimate within 20 percent of the actual cost of improvement.

The following guidelines generally should be followed in order to obtain a sufficiently accurate estimate:

1. A preliminary design of all mains and laterals should be made which will permit estimation of quantities and costs within the tolerances discussed above.
2. Principal laterals for surface drainage are considered to be those with a drainage area of one square mile or more, and which are needed to remove excess water from land to be protected.
3. For subsurface drainage improvements all open ditches draining one square mile or more, and all group main drains should be included in features for which a preliminary design is made.

In addition to estimating quantities and costs for clearing and grubbing, excavation, spreading of spoil, installation of drains and appurtenant structures, and rights-of-way, all other items required for the drainage system should be included in the cost estimate. Costs for some of these items should be estimated on an individual basis because of their size and importance. These include: bridges, culverts, irrigation flumes and grade control structures in mains and principal laterals; dikes, pumps, and tide and floodgates. Other, less costly items, may be estimated on a sampling basis. These include erosion control structures for side-water inlets, watergates for cross fences, and vegetation of ditch banks and critical erosion areas.

Preparation of plans and estimates

The plans for proposed improvements should be as complete as the data accumulated will permit. Plans and estimates prepared as a result of this survey will frequently form the basis for development of watershed work plans, issuance of bonds by drainage districts, or other large scale drainage operations. They should meet all Service standards for technical excellence and clarity. Data developed for these plans can be used in preparation of final design and should be carefully marked in the field and on the notes.

The following items should be included in the plans developed:

1. Map of project area showing proposed improvements. The map should show the following features:
 - a. Location of all mains and laterals which were surveyed. Laterals which are proposed but not specifically located should not be shown on the map.
 - b. Drainage area boundaries of mains and laterals.

- c. Existing land use, roads, railroads, towns, public utilities and pipelines, irrigation facilities, bridges and culverts which are proposed to be built or rebuilt, apparent property lines, and other structures or items which are specifically located.
 - d. Pumps, dikes, floodgates, etc. where applicable.
 - e. Any other features which will affect the drainage plan.
2. Profiles and cross sections - Profiles and cross sections of all mains and laterals surveyed should be included. Profiles should show normal ground elevation, spot elevations in field, existing and proposed ditch bottoms, design hydraulic gradeline, and bridge, culvert, and grade control structure elevations and dimensions. The elevation of the water stage in the outlet, after installation of project improvements, for the frequency of storm used for design, should be determined and shown on the profile of the main ditch.

Cross sections should show existing and proposed sections of channel, berm, and related dike or spoil bank; existing and proposed culverts and bridges, including deck, abutments, piers, and footings; and computation of earthwork quantities.

- 3. Typical layouts of on-farm drainage systems recommended and used in making cost estimates.
- 4. Typical plans for structures required for admitting runoff water to mains and laterals to prevent erosion, and for other structures needed.
- 5. Hydraulic computations for channel or floodway design.
- 6. Estimates of quantities and costs. These should be broken down by major items of work to the extent that any separate group or agency concerned with the project will be able to identify their obligations for installation.

Design Survey

General

Design surveys are those required for preparation of construction plans and specifications.

This type of survey is indicated:

- 1. After the reconnaissance and/or preliminary surveys have served their purposes and the owner or group has made the necessary financial and rights-of-way arrangements to proceed with the project, and further detailed surveys and investigations are needed to prepare construction plans and specifications.
- 2. For an individual farmer or small group in an area where Service experience in similar types of work has previously been obtained and there is no question as to project feasibility or the willingness and ability of the owners to obtain rights-of-way and finance the work.

Prior to construction of any drainage project, surveys and investigations should be made which show existing topography, structures, soil, ground water and hydrologic data needed for detailed location and design of all features to be included in the project. Maximum use should be made of data obtained in prior surveys. Additional data will usually be needed to prepare the necessary plans and estimates. For many small jobs the design survey may be the first and only survey to be made.

Data required for design

Data on hand should be evaluated and a determination made as to the amount of additional data needed for construction design. Depending on the age of existing data it may be necessary to make a random field check to verify it. For complex or unusual jobs it usually is necessary to prepare a survey outline as a guide to obtaining additional information. The following list covers the data usually required for design. Some of this usually will be available from previous investigations. This may be adapted to local conditions and a standard operating procedure (SOP) developed for obtaining it.

1. Delineate the problem area. Use soils map, supplemented by deeper borings, field observations and discussion with owners. Examine water table records for fluctuations, if available, and where subsurface drainage is needed determine if the problem area has been adequately defined.
2. For large projects ground water or piezometric contour maps should be made to show seasonal changes.
3. Determine extent, frequency, and seasonal flooding of the problem area and if the outlet is adequate.
4. Determine land use and crop requirements for drainage and any proposed changes in cropping pattern. (At this stage of project development all objectives to be obtained through drainage should have been defined.)
5. Obtain topography of the problem area, and select the location of all mains and laterals, interceptor drains, relief drains, and pipelines to accomplish project objectives.
6. Delineate drainage areas of all mains and laterals (open ditches) and all subsurface drains, which are a part of the project.
7. Survey and plot profiles and cross sections, adequate for design and estimation of quantities.
8. Make geologic and ground water investigations and obtain required testing to determine channel stability where necessary. SCS Technical Release No. 25, "Planning and Design of Open Channels," contains guidelines for this. Plot geologic ground water and test data on the profiles and cross sections where applicable.
9. In addition to items in 5 above, determine all other improvements needed, such as bridges, culverts, grade control structures, surface water inlets to buried drains or to open ditches, dikes, floodgates, pumping facilities, and all other structures and appurtenant facilities to fully meet the project objectives. Obtain necessary information for hydraulic, foundation and structural design of each feature.

10. Develop construction specifications for all items of work included in the plan. (Use standard specifications where applicable.)
11. Estimate needs and approximate costs of on-farm facilities - not included in the project improvements - such as land grading, land smoothing, drainage field ditches, buried drains, pumps, and other drainage structures.
12. Estimate quantities and costs for all features of the project.

Investigations for Surface Drainage

As previously discussed, the engineer responsible for design of a project must decide the kind and intensity of surveys and investigations which are needed for planning, design, and evaluation of the project which will meet the objectives of the owners. Where needed, an outline should be developed which lists in detail the factors to be considered, and the kind and intensity of surveys and investigations to be made. The kind of investigations needed for surface and subsurface drainage are different and will vary in different parts of the country.

In some areas the main problem will be surface drainage, and in other areas - subsurface drainage. In most situations, however, where drainage is a problem, it is necessary to investigate both surface and subsurface conditions. Investigations required for each type must be determined by the responsible engineer and the survey planned accordingly.

General

Surveys and investigations usually required for planning and design of surface drainage improvements are:

1. Topographic surveys.
2. Soil surveys and delineation of critical erosion areas.
3. Determination of land use and cropping pattern.
4. Precipitation and runoff investigations.
5. Stage-frequency investigation of high water in outlets, including tidal and lake level fluctuations where these are involved.
6. Profiles and cross sections of existing streams and ditches.
7. Geologic investigations and required testing for channel stability, where needed.

When preparing an outline for a particular survey the needs for future more intensive surveys should be kept in mind. Quite often a little extra work on a preliminary survey will save a lot of time later when making the design survey. Setting temporary benchmarks for future use, and to the degree of accuracy required for construction design, is an example of things which can be done when making preliminary surveys that will save time and expense later.

Vertical control

The survey for surface topography requires accurate differential leveling. A high degree of accuracy is required because gradients are usually quite low and

small differences in elevation are important. Usually a system of temporary benchmarks is established over the problem area as the first step in obtaining topographic and other data based on differences in elevation. Survey outlines and standard operating procedures should specify the accuracy to which elevations of temporary benchmarks (TBM's) should be checked. TBM's established during the preliminary survey should be numbered and identified so they can be used in making the design and construction layout surveys. Where a Coast and Geodetic Survey or Corps of Engineers benchmark is available within a reasonable distance from the problem area, vertical control should be based on the datum of the benchmark. In large watersheds it is helpful to prepare location maps of existing benchmarks. This may be done on an existing county highway or similar type map. Additional benchmarks and temporary benchmarks should then be established at convenient locations over the project area.

Topography

Information on the topography of the drainage problem area is essential. The topographic map should show all physical features, both natural and man made, which affect design of the drainage system. It should be in the detail necessary to locate existing drainageways and the drainage area boundaries. The detail of the topographic information required for planning and design of group enterprises and that required for on-farm field drainage is quite different. Minor differences in elevation within a field are not important to planning or design of ditches which are to serve a larger area. These minor differences are important, however, to the design of the field drainage system, which may include land grading, field ditches, row direction, etc. Good judgment is needed to determine the extent of topographic data needed for a particular purpose, and contour maps developed which will show the detail required for development of the plan. The flatter the topography is, the smaller the contour interval should be. These maps should be supplemented when necessary by spot elevations of isolated critical points, when these are evident and will fall between contour intervals.

In addition to surface contours, the location of ditches, roads, railroads, pipelines, other utility lines, farm boundaries, land use, section lines, boundaries of drainage enterprises, and other features, which may affect the plan for improvement, should be shown on the map. Quadrangle maps of the U. S. Geological Survey, Bureau of Reclamation, or Corps of Engineers will give a great deal of this information. It usually is necessary to supplement this data with information from aerial photographs and field surveys.

Field surveys are made in various ways according to customs of the engineer, equipment available, and detail required. The planetable with telescopic alidade is excellent for obtaining detailed topography. Transit surveys for both horizontal and vertical control are used in many cases. A common method of obtaining topographic data is to use aerial photographs for horizontal control and an engineers' level to obtain elevations.

Chapter 1, Engineering Surveys, of SCS Engineering Field Manual for Conservation Practices is a good manual on surveying. It should be consulted for guidance on practices and procedures. Standard notekeeping procedures, and requirements for accuracy, clarity, and identification should be followed. Survey data should be recorded and filed in a way which will facilitate its use in subsequent surveys - as well as for the one being made. Notekeeping procedures specified in Engineering Memorandum SCS 39 should be followed.

Soils investigations

The best soils map available should be used in drainage investigations. For surface drainage the standard soil survey usually is adequate for planning purposes. It will be necessary to obtain logs from some deeper borings to determine soil stability, permeability, and barriers which would affect channel construction. In some areas logs from deeper borings are necessary to obtain depths and types of compressible organic soils. For large complex jobs use the investigation procedures of NEH-8, Engineering Geology.

Soil classification

Standard soil surveys use the USDA Comprehensive Soil Classification System. Soil texture is recorded for every horizon. Conservation planning and determination of surface drainage needs are based on this classification.

In SCS construction operations, however, the Unified Soil Classification System is used. This is described in ASTM Designations D 2487 and D 2488. Use of the two systems of soil classification requires engineers and other technical personnel who work with both planning and construction to learn both systems and the areas where each is applicable. For example, on a surface drainage job the standard soil survey with USDA textural classification is used to describe soil profiles to shallow depths. The Unified Soil Classification is used for deep borings. Each system has characteristics which make it adaptable and useful for its particular purpose.

Soil surveys

The standard soil survey usually is available for design surveys but for some preliminary surveys a less detailed survey may suffice after field checking site conditions.

Information on the soils map will indicate those areas which have inadequate drainage and the degree of inadequacy and which require follow up investigations.

Investigations for channel stability

The standard soil survey usually will furnish information on soil stability adequate for design of ditches four feet deep or less. For deeper ditches, and some soil conditions, more detailed information is needed on soil strata to a depth below planned excavation of about one-half the proposed depth of ditch. This must be obtained from test holes along the route of the proposed ditch. The Unified Soil Classification System should be used for identification of material obtained from the test holes. Test holes should be dug, drilled, or bored initially at 500-foot intervals, and if correlation of material from holes is good, the spacing may be extended. If correlation is poor, the interval between holes should be decreased. The survey outline should specify the initial spacing and depth for obtaining soil logs. Knowledge of the complexity of geologic and soils distribution in the area is helpful in determining the amount of subsurface investigation required.

Data is needed on soil materials to determine design requirements for channel stability. Observations and records of side slopes and stability of existing channels in similar soils in the same area provide guides for determining the limits for side slopes and velocities for design purposes. The depth to a water table encountered in test holes should be determined and areas of unstable soils where the water table will be above the bottom of the proposed ditch should be located, as this will cause sloughing and other construction problems. Barriers of shale or rock which would not classify as common excavation to the required depth of channel should be located and identified. Results should be shown on the channel profile sheet.

Land use and cropping pattern

Land use can ordinarily be obtained from recently made aerial photographs. It may be necessary to check this in the field. The cropping pattern on cultivated land is needed to select proper rates of drainage and to make the economic evaluation. Data is needed for conditions prior to improvements and for proposed changes after project installation. This information can be obtained from individual landowners.

Precipitation, runoff, and stream stage records

Most of the available data on precipitation is published by the National Weather Service, and that for stream stages and discharge by the Geological Survey. Records pertaining to the area involved should be available for use. This information is needed to determine flooding conditions in the project area, capacities of existing streams, and adequacy of outlets for drainage improvements. In areas where drainage coefficients or pumping requirements have not been established the hydrologic factors will be needed to help establish them.

Location of mains and laterals

Prior to running levels for profiles and cross sections the main ditches and laterals to be included in the plan should be located on aerial photographs or topographic maps of the project. Each should be identified in such a manner that it can be easily referred to and located. It is desirable for laterals to be designated in a manner which will identify them with their outlets. One way to identify main ditches by Roman numerals and laterals which empty into them by this numeral followed by a capital letter. For instance, the first lateral above the outlet of Main No. I would be Lateral IA; and the second lateral would be IB. This could be extended on to the sublaterals by going into arabic numerals and lower case letters. Stream names should be used also, where the local name is known. Thus:

Main No. I, Cypress Bayou
 Lateral No. IA, Muddy Slough
 Lateral No. IA1
 Lateral No. IA2
 Lateral No. IA2a
 Lateral No. IB, Hickory Draw
 Lateral No. IB1
 Lateral No. IB1a
 Lateral No. IB1b

etc.

Location of ditches may be made from information on topographic maps or aerial photographs as supplemented with information obtained by field observation and property ownership maps. Considerations which govern the location and proper alignment of ditches appear in Chapter 5. Good alignment of mains and laterals is most important. A lot of thought and effort is fully justified in order to obtain the best alignment possible for the particular site conditions. After tentative locations of main ditches and laterals have been drawn on the photograph or map - often called "paper locations" - centerlines are located on the ground. If actual field location is different from the tentative map location, the map location should be changed to correspond with field location. The centerline on the map is scaled, and stations are marked for future use. When improving the alignment of ditches, care should be taken that the hydraulic grade line is not increased to the extent that the resulting velocity will cause a

stability problem in the ditch. When making design surveys in many locations it is necessary to use a transit or compass to establish the centerline of ditches. The centerline is staked at intervals of 100 feet or greater, depending upon the regularity of the ground surface and the alignment of the ditch. This may require use of an offset line if the proposed centerline is inaccessible or vision is obscured by trees or brush. Where the location is open and is not rigidly fixed by easement or other legal description, the engineer can stake out the centerline reasonably close with the use of range poles. This method often gives a sufficiently accurate alignment.

See Chapter 5 for recommendations as to use of simple curves and minimum radii in establishing alignment for mains and laterals.

Simple curves may be located with a transit and tape or with only a tape. A high degree of accuracy is not required. A field manual containing tables of functions of a 1-degree curve and formulas for solving problems in field location of curves will be helpful.

Refer to Chapter 1, Engineering Field Manual for Conservation Practices, for methods of staking curves.

Profiles and cross sections

Before obtaining profiles and cross sections of existing streams and ditches in the project, it is necessary to establish vertical control over the problem area by the network of temporary benchmarks described under Vertical control, page 2-13. The outline for the survey, whether it is to be a preliminary or design survey, should specify the manner in which the profiles and cross sections are to be obtained. In some cases it may be desirable to run lines of levels adjacent to the drainageways to be surveyed, taking profile readings and cross sections at predetermined intervals. This is usually done for design surveys and may be used for preliminary surveys. For preliminary surveys it may be desirable to run lines of differential levels at approximate right angles to the direction of drainage and across the problem area, at predetermined spacings, taking a ditch cross section wherever a line of levels crosses a drainageway. In the latter case, maximum use should be made of existing roads, railroads, and utility line rights-of-way for running lines of levels.

The distance between cross sections on a particular stream or ditch will be governed by the type of survey and the uniformity of the drainageway. In making a reconnaissance, few cross sections will be needed. In preliminary surveys the interval between cross sections may vary from about 500 feet to one mile, depending on uniformity. This would be in addition to obtaining cross sections at all existing bridges, side channels, etc.

In design surveys, profile readings and cross sections are taken at intervals of 100 to 1,000 feet along the established location, depending on the topography. Cross sections should be taken at topographic breaks in order to obtain accurate yardage. Where existing ditches, natural streams, or depressions occur, profile readings should be taken on normal ground along the low side of the ditch. Cross sections should extend far enough on either side of centerline to reveal the field elevation and changes in topography having a bearing upon the design, construction, and function of the proposed ditch. Low areas, important and large enough to be control points, should be located and their elevation and approximate areas obtained. Good judgment is necessary to obtain sufficient cross sections to meet standards of accuracy for yardage determination without doing an excessive amount of surveying.

When obtaining profiles and cross sections, surveys should originate and terminate on temporary or permanent benchmarks of known elevation. Additional TBM's should be set as needed, and located so as not to be destroyed by clearing operations. Turns should be made through all TBM's.

Recommendations for additional information and construction requirements

As surveys are made for the specific items listed, notes should be kept of any feature which will affect design or construction. Roughness coefficients of existing channels, which could possibly be used, should be noted. Clearing and grubbing required should be located and identified. Pipelines, other utility lines, fences, access roads, stability of existing ditches, etc. are items which will have a bearing on design and construction, and may have a significant effect on economic feasibility of the project.

The size and adequacy of existing bridges and culverts should be determined. The structure should be described and elevations obtained of the inverts of culverts, bottom of stringers of bridges, and road surfaces. The condition of the super-structure, foundation, piers, piling, abutments and footings should be determined where applicable.

When buildings are located within the area which may be affected by construction of the project, their location should be accurately established, and the structural stability of the building and its foundation determined.

Recommendations for all specific practices and features needed to provide a completely adequate drainage system should be passed on from the field survey party to the design engineer. The surveys and investigations are adequate only if the field engineer obtains the information required to design all features needed. Wherever possible the design engineer should make a personal reconnaissance of site conditions.

Investigations for Subsurface Drainage

Certain investigations are required for all drainage projects. These include mapping the topography, soils, present land use and cropping pattern; study of precipitation, evapotranspiration, runoff, and streamflow records pertinent to the area; and making profile, cross section, and soil profile investigations for open ditches. Geologic and ground water investigations are made as needed. Techniques for making these investigations are discussed in this Chapter under "Investigations for Surface Drainage," and in NEH Section 8, Engineering Geology. These methods of investigation are applicable to all parts of the country and to irrigated areas as well as non-irrigated areas.

In addition to the investigations required for all drainage projects there are some which are needed to furnish information on areas where preliminary investigations have indicated a need for subsurface drainage. Investigations for this purpose are covered in this section. These differ from those for surface drainage, as it is necessary to obtain information on ground water, perched water tables, salinity, and conditions below the upper soil horizons in addition to most of the information previously listed as needed for surface drainage. Ground water moves both horizontally and vertically through the soil and subsurface materials; therefore it is necessary to obtain information on the permeabilities of these materials. Permeabilities vary with the type of soil or subsurface materials and with the structure and the texture. Therefore it is necessary to investigate these to the extent that they have an influence on drainage. In summary, subsurface drainage investigations involve most of the items pertinent to surface drainage plus more detailed information on soil, subsoil and ground water conditions.

Additional information may be obtained from the "Guide for Investigation of Subsurface Drainage Problems on Irrigated Lands" published by the American Society of Agricultural Engineers (2).

General

Objectives of investigations for subsurface drainage are:

1. Inventory of project site conditions.
2. Diagnosis of the causes of excess ground water and/or salinity.
3. Determination of the appropriate remedial measures.
4. Procurement of data required for establishing the pattern, size, depth and spacing of the drains, outlet requirements, and for design of such auxiliary ditches, diversions and appurtenant structures as are needed.

The usual causes of excess wetness in humid areas can often be assessed in the reconnaissance of the project and will usually conform to one of the categories of site conditions discussed under "Subsurface-drainage problems" in Chapter 1. In some situations, particularly where rock outcrops or artesian pressure are evident or suspected, investigations to locate the source of wetness and to determine methods of correction are necessary.

The majority of subsurface drainage needed in the arid and semi-arid regions of the United States is within irrigated areas. There is a close relationship between irrigation and drainage in these areas. The amount of drainage water to be removed by subsurface drains is related to the irrigation water applied and, to some extent, the irrigation methods practiced. The physical information and data required for drainage is in part the same as that required for irrigation. Data on permeability, consumptive use, water quality, salinity, water table levels and surface topography are needed for both the practices of irrigation and drainage.

Surveys and investigations required

Surveys and investigations usually required for subsurface drainage include the following:

1. Topographic surveys
 - a. Detailed topographic surveys
 - b. Partial or strip-topography
2. Soils investigations
 - a. Standard soil survey maps
 - b. Data on salinity and alkalinity
3. Subsurface explorations
 - a. Logs of soil and subsoil materials
 - b. Hydraulic conductivity measurements

4. Ground water investigations
 - a. Position of the water table relative to the ground surface
 - b. Fluctuations in water table levels
 - c. Salinity of ground water
5. Irrigation practices and requirements.
 - a. Quality of irrigation water
 - b. Frequency and type of irrigation
 - c. Amount of water applied each irrigation
 - d. Leaching requirement and deep percolation loss
 - e. Field ditch losses
 - f. Source of water supply
6. Investigation of existing subsurface drainage systems

A short discussion of the above listed surveys and investigations is given in the following sections. More details can be obtained from the references cited.

Topographic surveys

Topographic surveys of varying degrees of detail are normally required for both surface and subsurface drainage. In the case of subsurface drainage, topographic maps are needed as a base map to which ground water and soils information can be referenced. Information on ground water levels can be tied-in to the topographic survey, which will give a direct relation between surface elevation and water-table levels.

Seep areas and vegetation indicative of seasonal or deep seated sources of seepage or prolonged high-water table should be located on the map. Particular attention should be given to the elevation of control points such as ridges, knolls, low pockets, natural drainageways, rock outcrops, and outlet channels.

Drainage investigations in irrigated areas and seep areas of non-irrigated lands may require complete topographic coverage. The amount of detail required will vary with the complexity of the surface relief. Normally this detail will need to be such that maps can be prepared with a contour interval in the range of one to five feet. Provisions should be made to tie in piezometers and/or observation wells. Their location and elevation should be obtained along with other topographic data.

In a few cases, the required location of subsurface drains may be so apparent that detailed topographic coverage of the entire area under investigation may not be necessary. In these cases partial or strip topography along the proposed routes of the drain or drains may be adequate. This may be obtained through profile and cross-section surveys, along the routes of the drains.

Soils investigations

Standard soil surveys are needed for all areas being planned for subsurface drainage. These surveys are currently available in many areas, but if not, the best soils map available should be used. Additional information is usually needed, however. Soil borings to approximately one and one-half times the estimated depth of drain are needed to determine depth and thickness of the different soil materials, estimation of permeability of the different soil strata, location of layers of very low permeability and other materials which should be considered in design. These layers may include clay pans, shale, sandstone, bog iron, rock, gravel or quicksand. Such materials may require inclusion of filters, gravel envelopes, or special backfill treatment in design of the system.

The pH of the soil and the amount of sulfates present will have an effect on kinds of drain materials that can be used. Borings needed to furnish this information are described below under "Subsurface explorations." Information on characterization of soil materials and their structure and permeability is contained in the USDA Soil Survey Manual (3). Engineering properties of soils are described and requirements for investigations are covered in NEH Section 8, Engineering Geology.

The drainage of saline and alkali soils in irrigated areas must give attention to their particular requirements. For this reason it is necessary to delineate saline and alkali areas and determine the degree of salinity or alkalinity. In some areas this has been done in connection with standard soil surveys and is noted on soil maps. Where this has not been done it is necessary to make these determinations along with other investigations for drainage. In all cases it is desirable to obtain the services of a soil scientist or geologist to delineate and classify salty lands. If this is not possible, samples should be taken and submitted to a testing laboratory. Agriculture Information Bulletin No. 279 (4) provides a guide to the sampling procedure. It is recommended that for fields of 40 acres or less, two sampling sites be selected in areas which are apparently affected and two sites in unaffected areas. Samples should be taken to the plow depth and at 12-inch depths thereafter.

The U. S. Salinity Laboratory has developed a portable test kit for the purpose of determining salinity and alkalinity in the field. It is assembled in a small suitcase for convenience in transportation to field locations. Use of the kit is described in USDA Circular No. 982 (5). Operation is not difficult and does not require the services of a soil scientist.

Subsurface explorations

Subsurface drains in arid irrigated areas are usually placed at a depth of 6 to 9 feet below the ground surface; and in humid areas the drains are usually placed from 3 to 6 feet below the surface. Ground water flows to the drains through the soil and subsoil materials extending from the water table surface to a depth of several feet below the drain. (See "Principles of flow in the saturated zone," Chapter 1.) The depth of this region of flow will vary with the hydraulic conductivity of the subsurface materials present. For this reason it is necessary to explore these materials to a depth of about one and one-half times the drain depth, or deeper, to determine if there is a significant change in the hydraulic conductivity.

Logging soils and subsurface materials

Subsurface explorations are usually made by boring test holes on a rectangular grid pattern to cover the area under consideration. The spacing of borings should be based on a knowledge of soils, local geology and experience gained in a particular work area. Borings must be spaced close enough to permit the correlation of subsurface strata. In alluvial materials where sediments are heterogeneous materials deposited in a complex pattern, this spacing may need to be 100 feet or less. In areas of residual homogeneous soils the spacing may be as great as 1,000 feet. In practical field application the usual procedure is to select a grid spacing based on previous experience; start subsurface explorations and attempt to correlate the data from the borings progressively. If the correlation between borings is poor or lacking, the data should be supplemented by cutting the original grid spacing in half and repeating the correlation process. It often develops that in certain parts of an area correlation may be good, whereas in other sections it may be poor. In this latter case the grid pattern should be supplemented with additional borings to the extent that the subsoil and substrata configuration is made clear. Borings on large areas should be located on a grid pattern, usually rectangular. The lines of borings may be oriented in any convenient direction to fit the area. When the spacing and grid pattern have been established, guide stakes can be placed at field boundaries and interior stakes sighted in. If a topographic survey is to be made, the locations of borings can be tied in with it.

The depth of borings should be at least 1-1/2 times the drain depth. Since the actual depth of the drain which may be installed as a result of the investigations is not known, the borings are normally made to a depth of approximately twice the average drain depth in the area. A few deeper borings - 15 to 20 feet - interspersed with the others, should be made to determine the composition of underlying strata. The presence of certain types of strata may require the alteration of the entire drainage plan. If initial borings in the area indicate a rather uniform configuration of subsurface layers, the spacing of the borings may be increased.

Each boring should be numbered and identified by that number on the topographic map. Logs of each boring should be prepared in the field and identified by number and location. A sample sheet for logging the soils is given in Figure 2-1.

Information which should be recorded for all borings includes:

1. State, soil conservation district, work unit, farm or project, and location.
2. Name of technician logging the hole.
3. Date.
4. Boring number.
5. A stratigraphic description of the subsoil profile.
6. Estimated hydraulic conductivity of each significant layer.
7. Location of water table at time of boring.

Although a few borings may be made by hand auger, power equipment should be provided where many, and/or deep, borings are needed.

LOG SHEET FOR SOIL BORING

State _____ SCD _____ Work Unit _____

Farm or Project _____ Location _____

Technician _____ Date _____

Boring No. _____ Location _____

Soil Symbol _____ Land Use _____ Crop Condition _____

Log-Feet

| | | |
|-----|--|-----|
| 0 | | 12 |
| 1- | | 13- |
| 2- | | 14- |
| 3- | | 15- |
| 4- | | 16- |
| 5- | | 17- |
| 6- | | 18- |
| 7- | | 19- |
| 8- | | 20- |
| 9- | | 21- |
| 10- | | 22- |
| 11- | | 23- |
| 12- | | 24- |

Classification Symbol

GW - Gravel, well graded
 GP - Gravel, poorly graded
 SW - Sand, well graded
 SP - Sand, poorly graded
 CH - Clay, high plasticity
 CL - Clay, low plasticity
 MH - Silt, medium plasticity
 ML - Silt, low plasticity
 GC - Clayey gravels, plastic
 GM - Silty gravels, non-plastic
 SC - Clayey sands, plastic
 SM - Silty sands, non-plastic
 OH - Organic clays, plastic
 OL - Organic silts, non-plastic
 Pt - Peat & Muck

Wetness

1 - Dry 3 - Wet
 2 - Moist 4 - Saturated

Estimated Permeability

(S) less than 0.20 in/hr (MS) 0.20 to 0.80 in/hr
 (M) 0.80 to 2.50 in/hr (MR) 2.50 to 5.00 in/hr
 (R) 5.00 in/hr or more

Note: Show symbol to indicate the sediment type, number for wetness and circled letter for permeability.

Example: A slowly permeable wet clay with low plasticity would be logged as shown.

Remarks:

CL
 3
 (S)

Figure 2-1, Sample form for soil log

The Unified Soil Classification System is recommended for use in logging the soil materials. The Unified Soil Classification Symbols are defined as follows:

- GW - Well-graded gravels and gravel-sand mixtures, little or no fines.
- GP - Poorly graded gravels and gravel-sand mixtures, little or no fines.
- GM - Silty gravels, gravel-sand-silt mixtures.
- GC - Clayey gravels, gravel-sand-clay mixtures.
- SW - Well-graded sands and gravelly sands, little or no fines.
- SP - Poorly graded sands and gravelly sands, little or no fines.
- SM - Silty sands, sand-silt mixtures.
- SC - Clayey sands, sand-clay mixtures.
- ML - Inorganic silts, very fine sands, rock flour, silty or clayey fine sands.
- CL - Inorganic clays of low to medium plasticity, gravelly clays, sandy clays, silty clays, lean clays.
- OL - Organic silts and organic silty clays of low plasticity.
- MH - Inorganic silts, micaceous or diatomaceous fine sands or silts, elastic silts.
- CH - Inorganic clays of high plasticity, fat clays.
- OH - Organic clays of medium to high plasticity.
- PT - Peat, muck and other highly organic soils.

Based on Visual-Manual Procedure, ASTM D 2488

A visual-manual procedure for description of soils is given in ASTM Designation D 2488, and laboratory methods for classification of soils for engineering purposes is given in ASTM Designation D 2487.* Field tests and estimates of the hydraulic conductivity (HC) should be related to similar soils where the HC has been measured in place and to laboratory measurements of the HC on undisturbed samples of similar soils.

Check lists have been developed for description and field identification of soil materials, based on the Unified Soil Classification System. See Figures 2-2 and 2-3. These lists may be printed on double-weight field-book size paper for field use.

Soil samples for laboratory testing

Soil samples for use in laboratory analysis are needed for benchmark soils in each particular drainage problem area. Each significantly different stratum in a soil profile should be sampled for the laboratory tests. These tests generally should include hydraulic conductivity, and in special cases development of moisture retention curve, total pore space, mechanical analysis, and determination of organic matter. Undisturbed samples are necessary for the hydraulic conductivity, moisture retention, and pore space tests. Disturbed samples are suitable for the others. Various types of equipment have been developed for taking in-place samples. Taking the samples in an open pit has the advantage that a sample may be taken from a horizontal or a vertical direction, in order to obtain both horizontal and vertical hydraulic conductivity.

In arid irrigated areas disturbed samples should also be taken for testing the salinity of the soil solution extract. The first of these should be taken of the topsoil to the plow depth and others at depth increments of approximately one foot to the maximum depth of root zone (4). A small--1/2 pound--sample is adequate.

*American Society for Testing and Materials, 1916 Race Street, Philadelphia, Pa. 19103

| DESCRIPTION OF COARSE-GRAINED SOILS - ASTM D 2488 | | | |
|--|--|---|---|
| 1. Typical Name: | Boulders | Cobbles | Gravel Sand |
| | Add descriptive adjectives for minor constituents. | | |
| 2. Gradation: | Well-graded | Poorly-graded | (Uniformly-graded or Cap-graded) |
| | Describe range of particle sizes or predominant size or sizes as coarse, medium, or fine sand or gravel. | | |
| 3. Maximum Particle Size: | Note percent boulders and cobbles in total sample. | | |
| 4. Size Distribution: | Approximate percent gravel, sand and fines in fraction finer than 3 in. (76 mm). Indicate plasticity of fines. | | |
| 5. Grain Shape: | Angular | Subangular | Subrounded Rounded |
| 6. Mineralogy: | Rock type for gravel, predominant minerals in sand. Note presence of mica flakes, shaly particles and organic material. | | |
| 7. Color: | Use common terms or Munsell notation. Based on moist or wet condition. | | |
| 8. Odor: | None | Earthy | Organic (Dark-colored soils only) |
| 9. Moisture Content: | Dry | Moist | Wet Very Wet |
| 10. Natural Density: | Loose | Dense | |
| 11. Structure: | Stratified | Lensed | Nonstratified |
| 12. Cementation: | Weak | Strong | (Note reaction with HCl as none, weak or strong.) |
| 13. Origin: | Examples - Alluvial, Colluvium, Till, Outwash, etc. | | |
| 14. Group Symbol: | Estimate. (See Field Identification below.) | | |
| Example: Silty Sand, well-graded gravelly. Maximum size, 8 in., about 5 percent cobbles. About 20 percent subrounded granite gravel, 65 percent subrounded to subangular quartz sand, and 15 percent low plasticity fines. Light brown (7.5 YR 6/4). Moist. Dense. Stratified. No reaction to HCl. Alluvial sand (SM). | | | |
| FIELD IDENTIFICATION - COARSE-GRAINED SOILS | | | |
| COARSE PARTICLE GRADE SIZES | | | |
| Grade Name | Grade Size | Sieve No. | Comparative Size |
| Boulders | 12" + | - | Basketball or larger |
| Large Cobbles | 6" - 12" | - | Cantaloup to Basketball |
| Small Cobbles | 3" - 6" | - | Orange to Cantaloup |
| (Exclude fraction larger than 3" from Unified Classification) | | | |
| Coarse Gravel | 3/4" - 3" | - | Cherry to Orange |
| Fine Gravel | 1/4" - 3/4" | 4 - 3/4" | Pea to Cherry |
| Coarse Sand | 2.0 - 4.76 mm | 10 - 4 | Wheat Grain to Pea |
| Medium Sand | 0.42 - 2.0 mm | 40 - 10 | Sugar to Wheat Grain |
| Fine Sand | 0.074 - 0.42 mm | 200 - 40 | Flour to Sugar |
| COARSE-GRAINED SOILS | GRAVEL AND GRAVELLY SOILS More than half of Coarse Fraction (by weight) is larger than 1/4 in. size. | CLEAN GRAVELS Will not leave a dirt stain on a wet palm. | Wide range in grain sizes and (Unified) substantial amounts of all intermediate particle sizes. GW |
| | | DIRTY GRAVELS Will leave a dirt stain on a wet palm. | Predominantly one size or a range of sizes with some intermediate sizes missing. GP Nonplastic fines or fines with low plasticity (for identification of fines see characteristics of ML fine-grained soils). GM Plastic fines (for identification of fines see characteristics of CL fine-grained soils). GC |
| | SAND AND SANDY SOILS More than half of Coarse Fraction (by weight) is smaller than 1/4 in. size. For visual classification the 1/4 in. size may be used as equivalent to the No. 4 sieve size. | CLEAN SANDS Will not leave a dirt stain on a wet palm. | Wide range in grain size and substantial amounts of all intermediate particle sizes. SW |
| | | DIRTY SANDS Will leave a dirt stain on a wet palm. | Predominantly one size or a range of sizes with some intermediate sizes missing. SP Nonplastic fines or fines with low plasticity (for identification of fines see characteristics of ML fine-grained soils). SM Plastic fines (for identification of fines see characteristics of CL fine-grained soils). SC |

9224-002-STATISTICS, 00, 1960

Figure 2-3, Check list for coarse-grained soils

Further information on sampling and testing soils for analysis of salinity and alkalinity is given in Agriculture Handbook 60 (6) and USDA Circular No. 982 (5).

Hydraulic conductivity

The terms "hydraulic conductivity," "permeability" and "coefficient of permeability," although having different technical meanings, are often used in the same sense. The "coefficient of permeability" is defined (7) as the rate of flow of water through a unit cross-sectional area under a unit head during a unit period of time. The term "hydraulic conductivity" may be defined (8) as the coefficient K in Darcy's law $v = Ki$ where v is the velocity of seepage and i is the hydraulic gradient. Values of K depend on properties of the fluid, such as viscosity, as well as that of the porous medium, and reflect any interactions of the fluid with the porous medium such as swelling of soil and its attendant reduced porosity. The term "permeability" is used in a general sense to indicate the relative ability of soils to transmit water. In the following discussion the term "hydraulic conductivity" (HC) will be used in the specific sense to mean the rate of transmissibility of water through soil assuming a hydraulic gradient of unity.

In the past, much research work has been done on developing various methods and techniques for determining the permeability of soils. In general, these methods and techniques fall into two types depending on whether the soil was tested "in place" or whether soil samples were transported to the laboratory for testing. Tests made "in place" are generally considered superior as it is almost impossible to obtain samples and transport them to the laboratory without disturbing them to some degree, thereby altering their permeability.

Laboratory-testing methods involve placing soil samples in permeameters where they are subjected to a head of water for a designated period of time. By measuring the amount of water that passes through the sample in a given period of time the permeability can be determined.

Laboratory tests may be made in either of two ways. An undisturbed core may be obtained in the field with a special core sampler and taken to a laboratory for tests or a disturbed sample may be obtained and taken to the laboratory where it will be dried, reduced to granule size, and then packed into a permeameter tube for testing. Equipment for permeability tests is relatively inexpensive and may be purchased complete or fabricated locally. Tests and equipment are described in USDA Agriculture Handbook 60 (6) and USDA Technical Bulletin No. 1065 (7).

In-place measurement of permeability may be made by several methods. The procedures which have been used most commonly are described in Special Publication SP-SW-0262 of the American Society of Agricultural Engineers (9). In addition to a brief description of the different methods of measuring saturated hydraulic conductivity of soils, the equipment required is listed and the merits and limitations of each method are discussed. A list of references for details on theory and application is given.

The auger-hole method is the simplest method for measuring the hydraulic conductivity of soil in place in the presence of a water table. It is also one of the most reliable methods. Several investigators have contributed to the development of the theory and application of the method and a large part of their work is summarized by Luthin in Vol. VII of Agronomy Monographs (10) and by Kirkham (11). A good discussion of the method and equipment required is given by Van Beers in Bulletin No. 1 of the International Institute for Land Reclamation and Improvement, Wageningen, the Netherlands. Graphs, in metric units, are given for solution of the formula (12).

The number of tests which are needed to arrive at the value for hydraulic conductivity to use for design depends on the uniformity of the soil profile below the water table. This test, then, should be made after the soils have been logged or concurrently with the logging. It is a matter of judgment as to how many tests for HC should be made. The HC may vary quite a bit within short distances. Since it is desired to determine the average HC for a rather large area it is better to run several tests in different locations than to try to determine the HC in only one place. A good guide to go by is to use alternate logging holes for making tests of hydraulic conductivity. The number of logging holes and HC tests required are thus both related to the uniformity of the subsurface materials.

Other field permeability test methods are presented in NEH Section 8, Engineering Geology, and NEH Section 18, Ground Water.

Auger-hole method. - The principle of the auger-hole method is simple. A hole is bored to a certain distance below the water table. This should be to a depth about one foot below the average depth of drains. The depth of water in the hole should be about 5 to 10 times the diameter of the hole. The water level is lowered by pumping or bailing and the rate at which the ground water flows back into the hole is measured. The hydraulic conductivity can then be computed by a formula which relates the geometry of the hole to the rate at which the water flows into it.

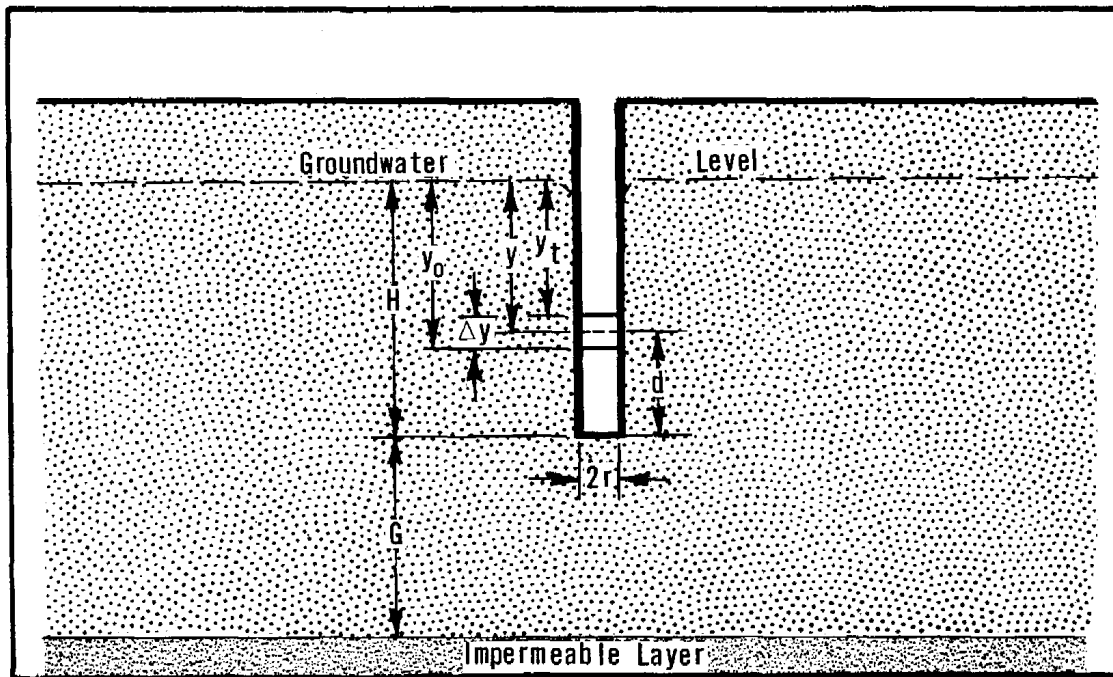

Figure 2-4, Symbols for auger-hole method of measuring hydraulic conductivity

K = hydraulic conductivity--inches per hour

H = depth of hole below the ground water table--inches

r = radius of auger hole--inches

y = distance between ground water level and the average level of water in the hole--inches, for the time interval Δt --seconds

Δy = rise of water--inches, in auger hole during Δt --seconds, time interval

G = depth of the impermeable layer below the bottom of the hole--inches. Impermeable layer defined as a layer which has the permeability of about one-tenth or less of the permeability of the layers above.

d = average depth of water in auger hole during test--inches

Good judgment is needed in determining how big a drawdown of the water level in the auger hole to make for the purpose of the test. Generally, a larger drawdown should be made for slowly permeable soils than for more permeable soils. A small drawdown for holes in sloughing soils may reduce the amount of sloughing. Pumping should stop when the water level is within a few inches of the bottom of the hole to prevent picking up sand in the pump.

Measurement of the rate of recovery of water in the auger hole should be completed before one-fourth of the total amount of drawdown has been recovered (10). Four or five readings should be taken at uniform short time intervals and a plot of the readings made to determine a uniform rate of recovery to use in the formula. Plottings of time in seconds against the residual drawdown in inches will indicate those readings at the beginning and end of the test which should be discarded and the proper values of Δt and Δy to use.

Equipment for auger-hole method. - - The equipment required to make the test consists of a suitable auger, a pump or bail bucket to remove water from the hole, a watch, and a device for measuring the depth of water in the hole, as it rises during recharge. For use in unstable soils a well screen may be necessary.

Many operators prefer a well made, light weight, boat or stirrup pump. One that is easily disassembled for cleaning is better. One type of pump which has given good service is a small double diaphragm barrel pump. This can be mounted on a wooden frame for ease of handling and use. The watch must have a second hand. For the depth measuring device a light weight bamboo fishing rod marked in feet tenths, and hundredths with a cork float works well. Other types of floats have been developed also. A juice can with a standard soldered to one end to hold a light weight measuring rod is good. A field kit for use in making the auger hole measurement of HC is illustrated in Figure 2-5. In addition to the items indicated on this figure, a watch and a soil auger will be needed.

In making the auger-hole measurement in fluid sands a perforated liner for the hole will be needed to keep the hole open and maintain the correct size. Several types of liners have been used. These include perforated or slotted downspouting (conductor pipe for roof runoff) and various types of well points and well screens, including a particular type of copper screen made in the Netherlands. For most kinds of fluid sands and silts this last screen is the best. It stays open much better than other types in these soils. For many soils the slotted downspouting is satisfactory, if adequate slot openings are provided to allow free flow into the pipe.

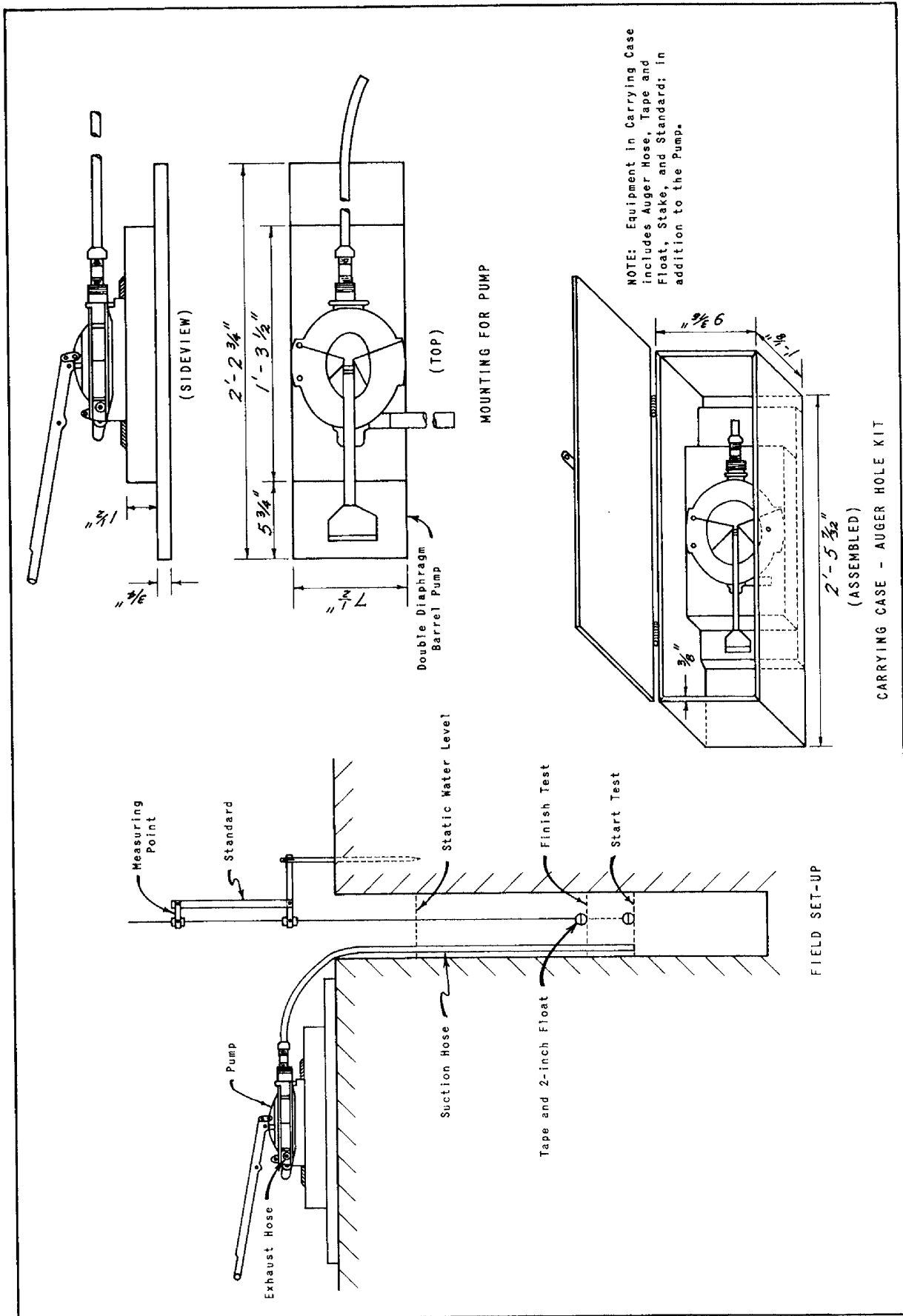

Figure 2-5, Equipment for auger-hole method of measuring hydraulic conductivity

FIELD MEASUREMENT OF HYDRAULIC CONDUCTIVITY AUGER-HOLE METHOD

For use only where bottom of hole coincides with barrier.

SOIL CONSERVATION DISTRICT Dry River WORK UNIT Salt Flat
 COOPERATOR John Doe - Farm No. 2 LOCATION 1/2 Mi. E. Big Rock Jct.
 SCD AGREEMENT NO. 264 FIELD NO. 4 ACP FARM NO. B-817
 TECHNICIAN Tom Jones DATE 1 June 64
 BORING NO. 4 SALINITY(EG) SOIL — WATER 5.6 ESTIMATED K 1.0 in/hr

| START 10:03 ELAPSED TIME | Δt | DISTANCE TO WATER SURFACE FROM REFERENCE POINT | | | Δy | RESIDUAL DRAWDOWN |
|-----------------------------------|------------|---|------------------|-------------------|------------|----------------------|
| | | BEFORE PUMPING | AFTER PUMPING | DURING PUMPING | | |
| | | B | A | R | | |
| SECONDS | SECONDS | INCHES | INCHES | INCHES | INCHES | INCHES |
| xx | xx | 43 | xx | xx | xx | xx |
| 0.0 | xx | xx | 81.5 | | 0.00 | 38.5 |
| 30 | | | | 79.0 | | 36.0 |
| 60 | | | | 77.5 | | 34.5 |
| 90 | | | | 76.0 | | 33.0 |
| 120 | | | | 74.0 | | 31.0 |
| 150 | 150 | | | 72.0 | 9.5 | 29.0 |
| | | | | | | |
| | | | | | | |
| | | | | | | |
| | | | | | | |
| | | | | | | |
| | | | | | | |
| | | | | | | |
| | | | | | | |
| | | | | | | |
| | | | | | | |

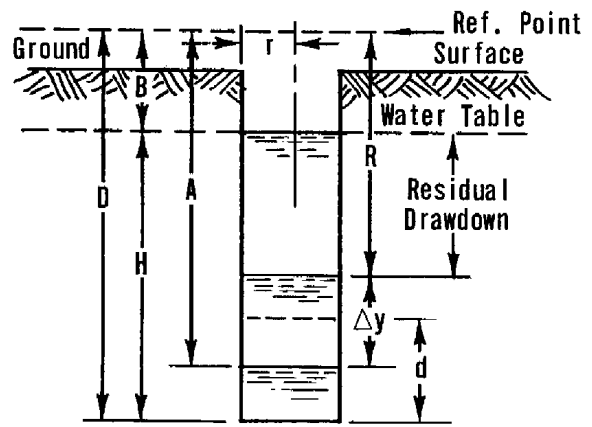
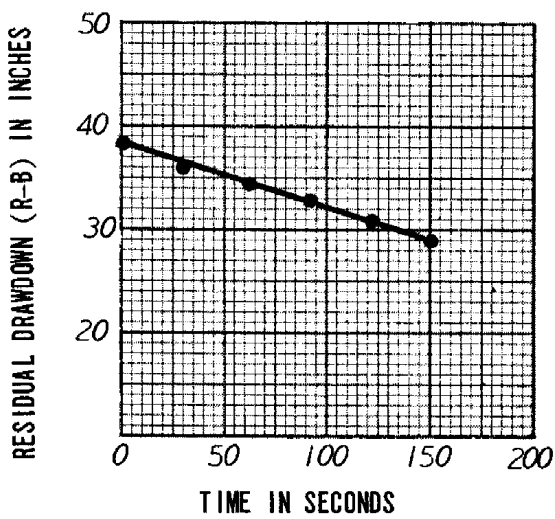

AUGER HOLE PROFILE

Figure 2-6--sheet 1 of 2, Auger-hole method of measuring hydraulic conductivity

Soil profile log holes are used for the test or a special hole may be augered for the purpose. The hole is pumped or bailed out 2 or 3 times to permit any puddled-over pores on the wall of the cavity to be flushed out by the in-seeping groundwater. This flushing process can be accomplished with a pump or bail bucket slightly smaller than the auger hole. The water level in the auger hole is allowed to become static following the cleaning process.

TEST: The water level is lowered in the hole with the pump or bail bucket. The distance the water level is lowered will be dependent on the sloughing tendency of the profile. Where sloughing is a problem a smaller drawdown should be used and possibly a liner or screen will be required. The water levels and time elapsed since beginning observations are recorded on the form. The rate of rise is used in the following formula to calculate K. The depth of water in the auger hole (D-B) should be about 5 to 10 times the diameter of the hole. Measurement of the rate of rise should be completed before $\Delta y \geq 1/4 (A-B)$.

$$K = 2220 \frac{r}{SH} \times \frac{\Delta y}{\Delta t}$$

- K = Hydraulic conductivity in inches per hour
- r = Radius of auger hole in inches
- S = Function from figure on chart below
- H = Depth of water in auger hole in inches (D-B)
- Δy = Raise of water level in inches in Δt timed interval (A-R)
- Δt = Time required to give Δy in seconds
- d = Average depth of water in auger hole during test $(D-A + \Delta y/2)$ in inches

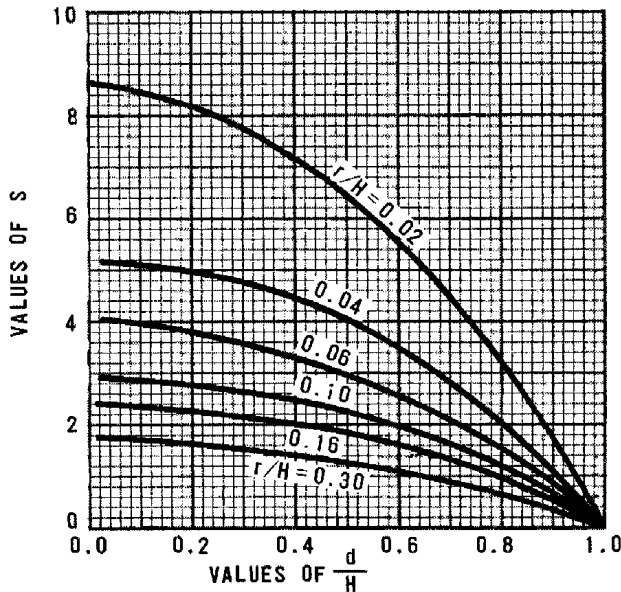
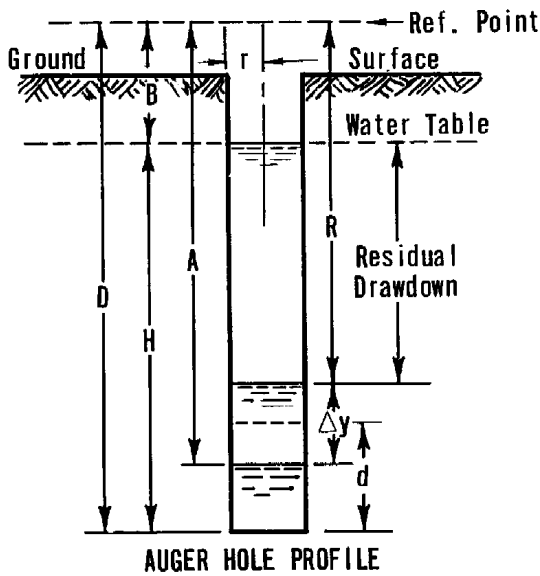

Hole Dia. $\frac{4''}{84''}$ Ground to Ref. = 11''
 Hole Depth $\frac{93''}{93''}$
 $D = \frac{93''}{93''}$
 $r = \frac{2}{93''}$
 $H = \frac{50}{93''}$
 $d = \frac{17}{93''}$
 $\Delta y = \frac{9.5}{93''}$
 $\Delta t = \frac{150}{93''}$ seconds
 $r/H = \frac{2}{50} = 0.04$
 $d/H = \frac{16.2}{50} = 0.32$
 $S = \frac{4.7}{2} \times \frac{9.5}{150}$
 $K = 2220 \times \frac{4.7}{2} \times \frac{9.5}{150}$
 $K = 1.2 \text{ in/hr}$

Figure 2-6--sheet 2 of 2, Auger-hole method of measuring hydraulic conductivity

The openings in the screen should not restrict flow appreciably. The head loss through the screen should be negligible and the velocity of flow through the openings should be small - 0.3 foot per second or less - to prevent movement of fines into the hole. These criteria will usually be met if the area of openings is 5 percent or more of the total area of the screen.

The Bureau of Reclamation uses 4-inch downspouting with sixty 1/8 inch by 1-inch slots per foot of length. This works well in a variety of soils. The screen from the Netherlands referred to is made from a punched brass sheet 2 mm. thick with holes averaging about 0.5 mm. diameter. It is rolled into a tube 8 cm. in diameter by 1 meter long. The reasons this screen works so well are that the sheet is rolled so that the direction in which the holes are punched is outward and the holes are variable in size. It has been used in many troublesome soils and there have been no reports of clogging or failure to keep fines out of the hole.

Formulas for determination of HC by auger-hole method. - - Determination of the hydraulic conductivity by the auger-hole method is affected by the location of the barrier or impermeable layer. For the case where the impermeable layer coincides with the bottom of the hole a formula for determining the hydraulic conductivity (K) has been developed by Van Bavel and Kirkham (13).

The formula is as follows:

$$K = \left(\frac{2220r}{SH} \right) \left(\frac{\Delta y}{\Delta t} \right) \quad (\text{Eq. 2-1})$$

Where S is a function dependent on the geometry of the hole, the static depth of water and the average depth of water during the test (14), and the other symbols are as defined on page 2-29.

A sample form for use in recording field observations and making the necessary computations is illustrated in Figure 2-6. This includes a chart for determining the geometric function S for use in the formula for calculation of the HC.

The more usual situation is where the bottom of the auger hole is some distance above the barrier. Formulas have been developed by Ernst (15) for computing the hydraulic conductivity in homogeneous soils by the auger-hole method for both cases. Converted to English units of measurement the formulas are as given below. Refer to Figure 2-4.

1. For the case where the impermeable layer is at the bottom of the auger hole, $G = 0$:

$$K = \frac{15,000r^2}{(H + 10r)(2 - y/H) y} \frac{\Delta y}{\Delta t} \quad (\text{Eq. 2-2})$$

2. For the case where the impermeable layer is at a depth $\bar{y} = 1/2H$ below the bottom of the auger hole:

$$K = \frac{16,667r^2}{(H + 20r)(2 - y/H) y} \frac{\Delta y}{\Delta t} \quad (\text{Eq. 2-3})$$

To obtain acceptable accuracy from use of this method the following conditions should be met:

$$2r > 2-1/2 \text{ and } < 5-1/2 \text{ inches}$$

$H > 10$ and < 80 inches

$y > 0.2 H$

$G > H$

$\Delta y \leq 1/4 y_0$

Charts have been prepared for solution of Equation 2-3 for auger holes of $r = 1\text{-}1/2$ and 2 inches. For the case where the impermeable layer is at the bottom of the auger hole the hydraulic conductivity may be determined from these charts by multiplying the value obtained by a conversion factor "f" as indicated on Figure 2-7, Sheet 2 of 2.

Other methods for determining hydraulic conductivity. - A method for determining the hydraulic conductivity in the absence of a water table has been developed by Bouwer (16). This is termed the double-tube method for field measurement of hydraulic conductivity of soil above a water table. The principle, method, and equipment required are discussed in the reference. Resulting measurements are less precise than measurements in a water table due to slow adjustments that must take place from capillary movement and air entrapment within the soil-pore space.

A field test for determining the permeability of soil in place and termed the Well Permeameter Method is used by the Bureau of Reclamation (17). This method, consisting of measuring the rate at which water flows outward from an uncased well under constant head, is particularly useful for estimating the need for lining an irrigation canal prior to construction. The apparatus required for the test and the procedure are described in the Bureau's Earth Manual.

Ground-water investigations

The purpose of a ground-water investigation is to provide information on the position and fluctuation of the water table at various points in the problem area. This will determine the extent and severity of the drainage problem over the area and will indicate the general type and location for subsurface drains. To obtain information on the position and fluctuation of the water table to develop a ground-water or piezometric pressure head contour map, it is necessary to establish observation wells and/or piezometers. Conditions of artesian flow should be investigated by use of batteries of piezometers.

It may be necessary to install a few observation wells just outside and adjacent to the project area to determine ground-water levels and water-table fluctuations in the perimeter area.

Observation wells

These are open wells placed at strategic points throughout the problem area to permit periodic observations of water-table levels. They may be cased or uncased wells depending on the stability of the soil materials at each location. Wells should be established on a grid pattern and spaced to give a close approximation of the ground-water surface. Observation wells should be established concurrently with making soil borings and measuring hydraulic conductivity. A number of the borings made should be cased--if necessary--and used as observation wells.

Size of wells and casing. - It is usually necessary to case observation wells so that they may be maintained for a period of at least one year. The purpose is to prevent sloughing and caving. Casing material may be sheet metal, downspouting, stovepipe, drain tile or tubing, wood, used well casing or pipe, or standard commercial types of well casing. Downspouting serves the purpose very well as it

HYDRAULIC CONDUCTIVITY BY AUGER HOLE METHOD FROM FORMULA ERNST

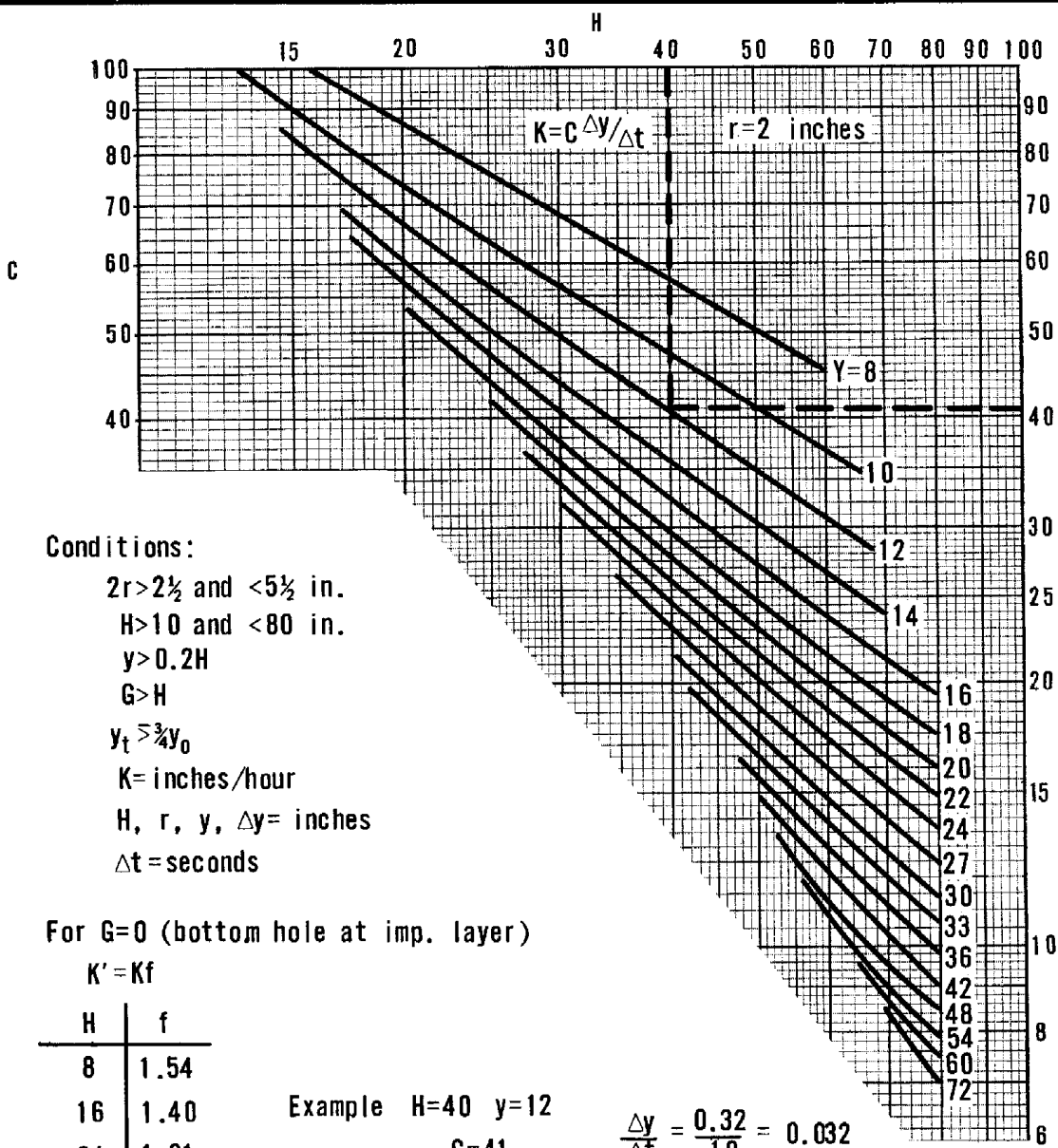

Conditions:

- $2r > 2\frac{1}{2}$ and $< 5\frac{1}{2}$ in.
- $H > 10$ and < 80 in.
- $y > 0.2H$
- $G > H$
- $y_t > \frac{3}{4}y_0$
- $K =$ inches/hour
- $H, r, y, \Delta y =$ inches
- $\Delta t =$ seconds

For $G=0$ (bottom hole at imp. layer)

$K' = Kf$

| H | f |
|----|------|
| 8 | 1.54 |
| 16 | 1.40 |
| 24 | 1.31 |
| 36 | 1.22 |
| 48 | 1.16 |
| 60 | 1.13 |
| 72 | 1.10 |

Example $H=40$ $y=12$
 $C=41$

$\frac{\Delta y}{\Delta t} = \frac{0.32}{10} = 0.032$

$K = 41 \times 0.032 = 1.31$ in/hour

REFERENCE From formula L. F. Ernst
Groningen, The Netherlands

$$K = \frac{16,667 r^2}{(H+20r) \left(2 - \frac{y}{H}\right) y} \frac{\Delta y}{\Delta t}$$

U. S. DEPARTMENT OF AGRICULTURE
SOIL CONSERVATION SERVICE
ENGINEERING DIVISION - DRAINAGE SECTION

STANDARD DWG. NO.
ES - 734
SHEET 1 OF 2
DATE 3-23-71

Figure 2-7, Hydraulic conductivity--auger-hole method by Ernst Formula

HYDRAULIC CONDUCTIVITY BY AUGER HOLE METHOD FROM FORMULA ERNST

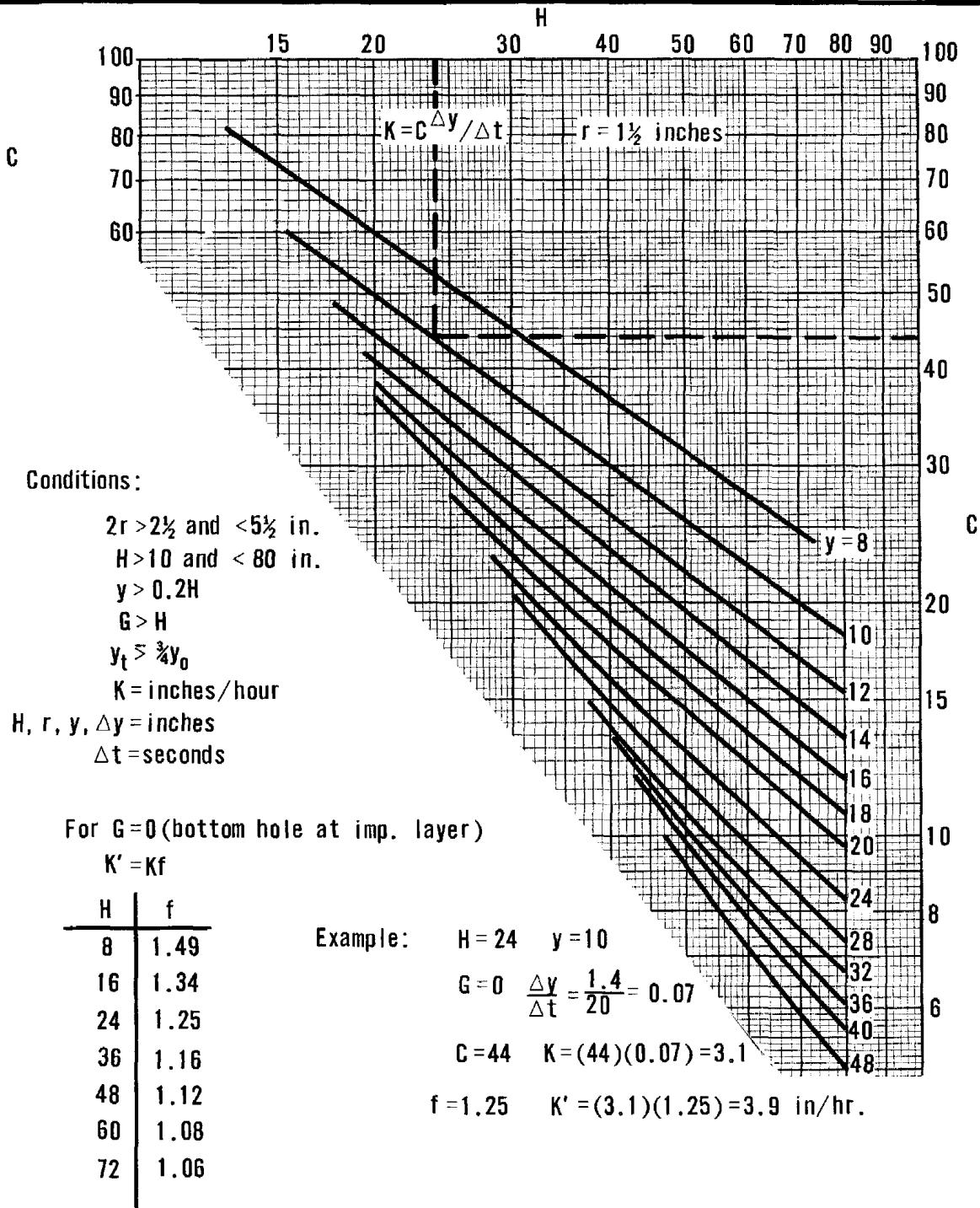

REFERENCE From formula L. F. Ernst
Groningen, The Netherlands

$$K = \frac{16,687r^2}{(H+20r)(2-\frac{y}{H})y} \frac{\Delta y}{\Delta t}$$

U. S. DEPARTMENT OF AGRICULTURE
SOIL CONSERVATION SERVICE
ENGINEERING DIVISION - DRAINAGE SECTION

STANDARD DWG. NO.
ES - 734
SHEET 2 OF 2
DATE 3 - 23 - 71

Figure 2-7--sheet 2 of 2, Hydraulic conductivity--auger-hole method by Ernst Formula

is sufficiently durable, cheap, light in weight, easy to handle, and can be installed with simple hand tools. The casing should extend at least 8 inches above the ground surface and be provided with a cap for protection.

Water surface fluctuations within large diameter observation wells often lag considerably behind actual water-table fluctuations in slowly permeable soils because of the relatively large water storage within the well. Reducing the well diameter reduces the water storage factor and the lag error. A small diameter observation well can be installed by using an adaptation of jetting techniques described under piezometers page 2-43. A 3/4-inch inside diameter pipe is jetted to a depth of 15 feet. Then a 3/8-inch outside diameter perforated tube is placed inside the larger pipe. The 3/4-inch pipe is pulled leaving the smaller tube in place, and the annular space around the tube is back-filled with coarse sand. The 3/8-inch perforated tube then functions as a small diameter well. In unstable soils a larger outside pipe should be used and the sand placed in the space between it and the tube before pulling it.

Small diameter jetted wells have functioned satisfactorily and have several advantages over the larger wells. They can be installed to much greater depths; installation is quicker; the cost of materials is reduced; and the lag error is considerably less.

Spacing. - The spacing of observation wells usually will be some multiple of the spacing for borings, as previously discussed. In areas where the subsurface profile is fairly uniform, the water-table surface usually is smooth without abrupt changes.

Generally, the water-table surface is smoother than the land surface. For these reasons, it is often possible to correlate water-table levels between observation wells that are spaced farther apart than soil borings. There should be no set rule for spacing observation wells as this should be a "cut and try" process as the investigation proceeds. The investigator should compare water-table levels observed in the wells and if there is a sharp departure from the general slope of the water-table surface, additional wells should be established to explain the irregularities.

Depth. - The depth of observation wells should be based on the expected low ground-water level. The purpose of the wells is to permit measuring the seasonal high and low ground-water levels within certain limits. Therefore, it is necessary to estimate what the low level will be. Soil profile and stratification also may indicate the proper depth for observation wells. Generally, a water level below 8 feet is not significant in drainage planning and wells to this depth are usually adequate except where artesian conditions exist.

Establishing well elevations. - In order to correlate water-table levels with ground-surface levels and to compile ground-water contour maps, the elevation of observation wells must be determined. Surveys are made to determine the elevation of the ground-surface at the location of each well and of the measuring point. The well casing usually provides a good measuring point.

Measuring water table levels and recording data. - Periodic measurements should be made to show the distance from the measuring point to the water-table level in each well. These measurements must be tabulated and reduced to show the actual elevation of the water level and to show the depth from the ground surface to the water level in each well. Forms which may be used for recording measurements are illustrated on Figure 2-8. A simple device for use in observation wells to obtain the maximum and minimum water elevations, which may occur between the readings, has

OR-16
APP-3-7-55

U.S. DEPARTMENT OF AGRICULTURE
SOIL CONSERVATION SERVICE

WELL RECORDS
FOR DRAINAGE INVESTIGATIONS

Property A. B. Doe
Location S. Sec. 10-75N-R8E
Technician R. B. Roe B. M. Elev. 2876.84

| NO. | ELEV. (Reference) | DATES (Readings Taken) | | | | | |
|------|----------------------|------------------------|------------|--------|------------|-----|------|
| | | 3-2-71 | 4-6-71 | 5-4-71 | | | |
| | | READ. | ELEV. W.S. | READ. | ELEV. W.S. | | |
| A-1 | 2872.6 | 4.6 | 2868.0 | 4.1 | 68.5 | 4.0 | 68.6 |
| A-2 | 2871.4 | 3.0 | 68.4 | 2.8 | 68.6 | 2.8 | 68.6 |
| A-3 | 2872.5 | 2.5 | 70.0 | 2.3 | 70.2 | 2.1 | 70.4 |
| A-4 | 2875.0 | *1.1 | 73.9 | 5.0 | 70.0 | 4.8 | 70.2 |
| etc. | " | " | " | " | " | " | " |
| " | " | " | " | " | " | " | " |
| " | " | " | " | " | " | " | " |
| " | " | " | " | " | " | " | " |

REMARKS

*Surface water near well-?
Level notes in Book-13

OR-16
APP-3-7-58

U.S. DEPARTMENT OF AGRICULTURE
SOIL CONSERVATION SERVICE

WELL RECORDS
FOR DRAINAGE INVESTIGATIONS

Property A. B. Jones
Location N.E. 1/4 Sec. 6-T10N-R3W
Technician R. B. Roe B. M. Elev. 1242.98

| NO. | ELEV. (Reference) | DATES (Readings Taken) | | | | | |
|------|----------------------|------------------------|------------|--------|------------|-----|------|
| | | 3-2-71 | 4-6-71 | 5-4-71 | | | |
| | | READ. | ELEV. W.S. | READ. | ELEV. W.S. | | |
| E-3 | 1238.4 | 6.8 | 1231.6 | 5.4 | 33.0 | 6.4 | 32.0 |
| E-4 | 1239.2 | 7.2 | 32.0 | 6.6 | 32.6 | 6.8 | 32.4 |
| etc. | " | " | " | " | " | " | " |
| " | " | " | " | " | " | " | " |
| " | " | " | " | " | " | " | " |
| " | " | " | " | " | " | " | " |
| " | " | " | " | " | " | " | " |
| " | " | " | " | " | " | " | " |

REMARKS

Piez. all in good condition.
Level notes in Book-28

Figure 2-8, Example of field sheets for well and piezometer records

been developed by two Corps of Engineers employees, Beryl G. Stinson and John G. Collins. The device is known as the "Max-Min Well Gage" and it can be shop made for about \$10 to \$20. Figure 2-9 illustrates the gage and details its construction.

The principle of the gage is simple. The float--refer to Figure 2-9--moves freely on the shaft; consequently, as the water table rises, the top slide is moved up the shaft by the float, and as the water table recedes, the bottom slide is moved down the shaft by the float. Field procedures used in reading the gage are as follows:

1. Pull the nylon line up until the sinker hits the bottom of the float and the line is fairly taut.
2. Clamp the line at the top of the cap.
3. Lift the entire gage assembly from the well.
4. Measure the position of the two slides and the float on the rod (the rod may be marked with a mark-a-lot pencil, and the position of the slides and float can then be read directly).
5. Push the slides flush with the top and bottom of the float assembly.
6. Lower the entire gage assembly back into the well.
7. Lower the nylon line until the sinker just rests on the spacer.
8. Clamp the line at the top of the cap.

Period of measurement. - Observation wells should be established to function for a period of at least one year. In irrigated areas with permeable subsoil and substratum sediments, water-table levels fluctuate considerably during the growing season. Fluctuations of as much as 8 feet are common. Under these conditions, any one set of measurements usually will not furnish the information needed on high and low water elevations. For this reason, a series of measurements must be made, usually one or two each month, for a period of several months to a year. When the max-min well gage is used, readings may be less frequent. By comparing the data by months, the highest water-table condition can be detected. This is the critical condition and should be used as a basis for drainage design.

Piezometers

The piezometer (7) is a useful tool in determining ground-water conditions, particularly where artesian pressures are suspected. There is a basic difference between a piezometer and an observation well. The piezometer is a small-diameter pipe driven into the subsoil so that there is no leakage around the pipe and all entrance of water into the pipe is through the open bottom. The piezometer indicates only hydrostatic pressure of ground water at the specific point in the soil where the lower end or opening of the tube is located. In the case of observation wells, the entrance of water into the well is through the entire section penetrated below the water table. The observation well reflects a composite of all ground-water pressure to the depth of the well.

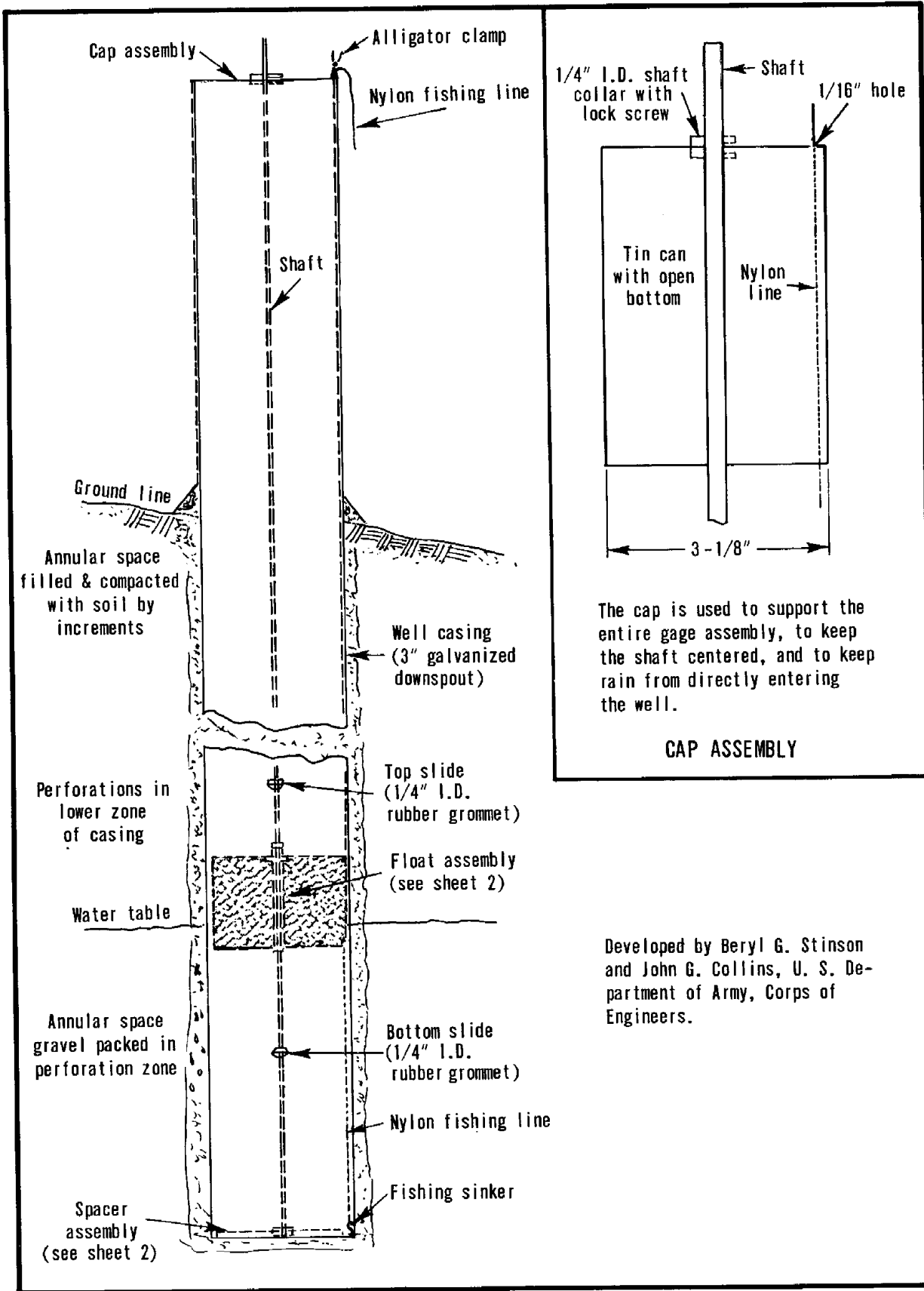

Figure 2-9, Max-min well gage

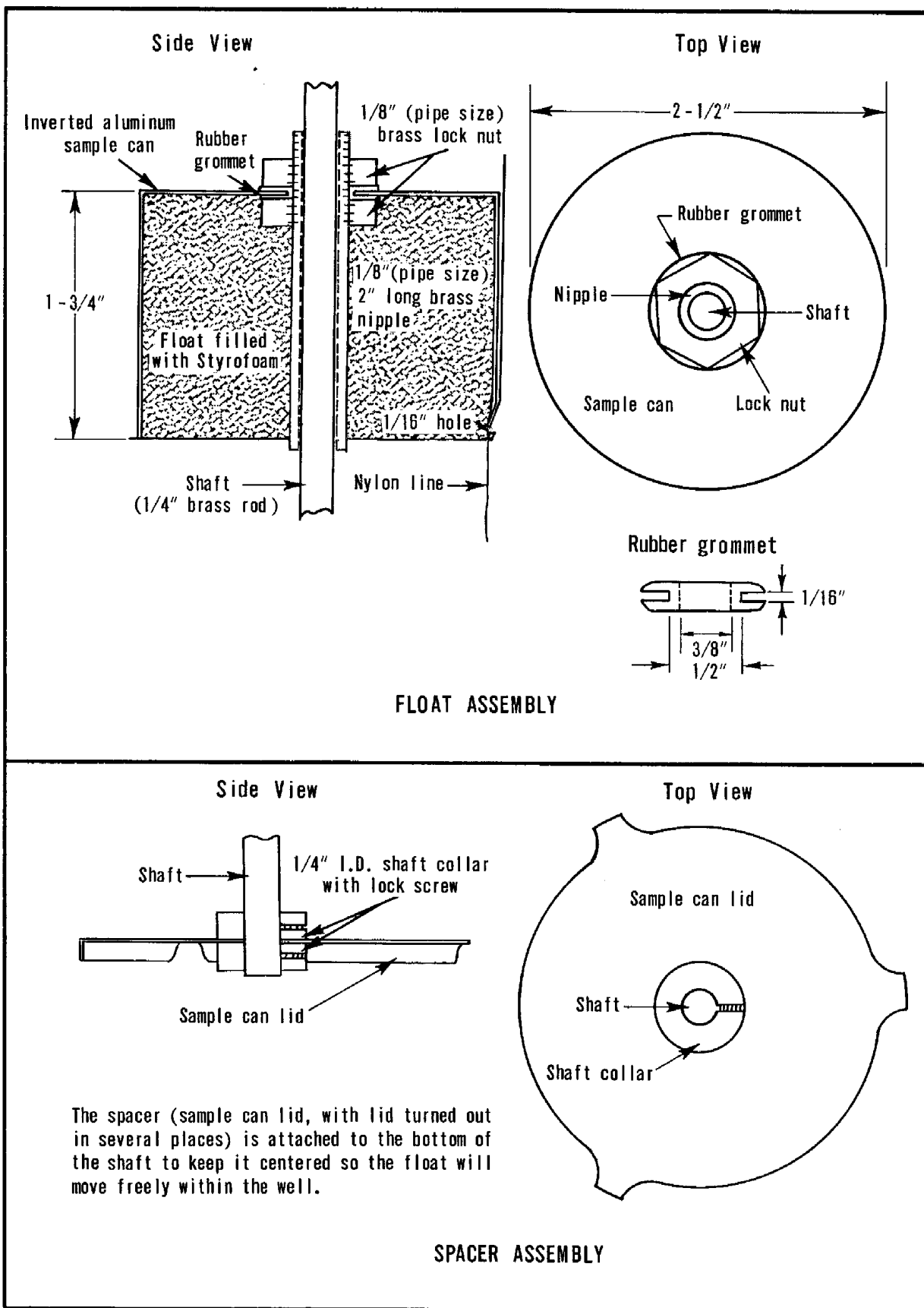
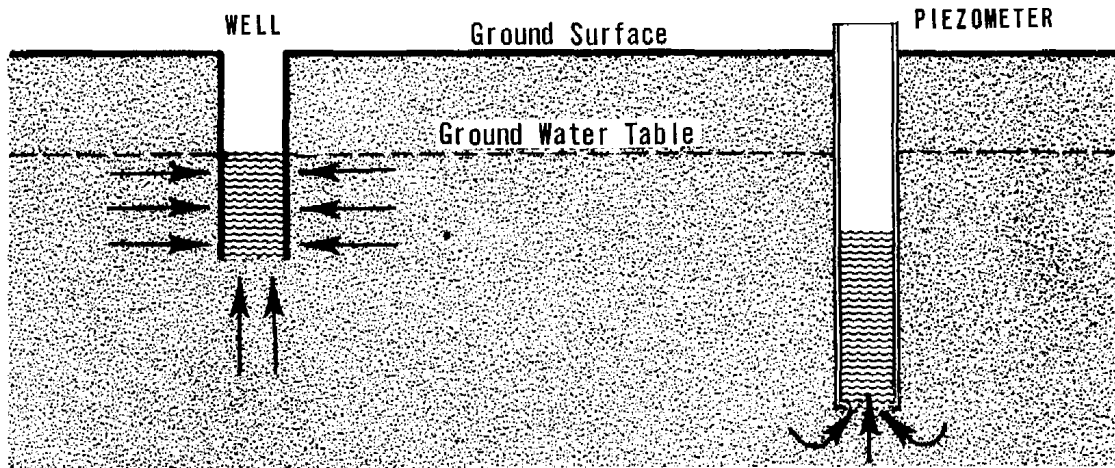
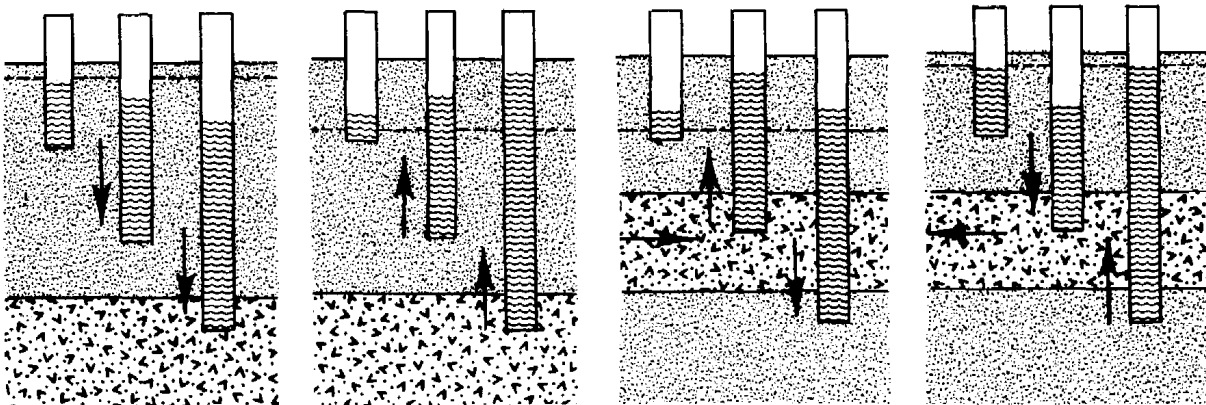

Figure 2-9--sheet 2 of 2, Max-min well gage



As the piezometer is a tool that can be used to determine the hydrostatic pressure at a point in the soil profile, it is valuable in detecting artesian pressures and differences in pressure between various strata. Ground water moves from a point of high hydrostatic pressure to one of low pressure; therefore, the flow of ground water can be charted if the various hydrostatic pressures are known. Batteries of piezometers of different lengths can be used to detect the vertical movement of ground water, and piezometers spaced at horizontal intervals can be used to detect horizontal seepage or movement. This technique is especially useful in studying ground-water movement adjacent to canals, drains, and reservoirs.



The piezometers indicate that the ground water is going down and that there is some natural drainage.

The piezometers indicate a hydrostatic pressure or that there is water coming up from a deeper strata.

The piezometers indicate a hydrostatic pressure in a stratum, and that water is being forced both up and down from the stratum.

The piezometers indicate that ground water is moving into a stratum and going out of the area.

Piezometers may be installed by driving or by jetting into position by high velocity water jet. If more than just a few piezometers are to be installed the jetting technique is recommended.

Installation by driving. - Before driving the tube is started, a loose rivet is placed in the lower end of the 1/4-, 3/8-, or 1/2-inch pipe to keep soil from entering. The exact length of the pipe should be noted so that the elevation of the bottom of the pipe after driving may be determined. When the desired depth is reached, a rod is inserted and the rivet is punched out, leaving an open pipe--or piezometer.

There are several types of piezometer drivers available. One type is a special hammer fashioned like a steel fence-post driver. It consists of two pieces of 3/4-inch pipe, one 15 inches long and the other 5 feet, joined by a 1-foot section of 1-1/2-inch pipe filled with lead. This leaded section is fitted with a steel plug at each end to receive the impact of the blow. The piezometer is driven into the soil with the driver until it reaches the desired depth. Since hand driving of a 15- or 20-foot piezometer in some formations may entail considerable labor, the use of this method is definitely limited. Placing a joint and coupling about 1 foot from the bottom of the pipe slightly enlarges the hole through which the pipe passes. This helps to reduce side friction and cuts down on driving resistance. Piezometers may be driven to about 40 feet with a pneumatic jack-hammer if the top of the piezometer pipe is fitted with a driving cap.

For successful installation and operation of piezometers, the soil at the lower end of the piezometer should be removed by flushing a small cavity at the bottom of the pipe. The equipment needed for flushing includes a water container, stirrup pump, and enough plastic tubing to reach the bottom of the deepest piezometer. The piezometer is tested for sensitivity by filling the piezometer with water and observing the rate of drop. If the rate of drop is very slow, the flushing should be repeated.

See Figure 2-10 for an example of a form for recording information on installation of piezometers. Figure 2-8 illustrates a form for recording readings.

Installation by jetting. - Equipment required for jetting piezometers into position consists of a high pressure pump, a supply of water, and the necessary fittings to make the connections for directing the jet of water through the piezometer. Commercial orchard spraying rigs have been used successfully for the pump and water supply tank, and the fittings added have been varied according to the ingenuity of the people developing the equipment and the convenience and ease of operation desired (18).

As the piezometer is jetted into position and to the depth desired by the high velocity water jet the sediments dislodged and suspended in the water flow to the surface by the passage around the pipe. An experienced operator can examine the flow of these sediments and by correlating the characteristics of the materials with the "feel" of the pipe as it is jetted into position he can develop a reasonably good log of the profile.

Installation of piezometers by jetting in coarse sand or gravel requires the addition of drillers mud to the water used for jetting. If this is not done the water from the jet flows into the formation and the skin friction on the pipe becomes too great for it to be moved. In areas where this condition is present the equipment should include an additional water tank for mixture of the drillers mud. A pump will be needed for agitation of the mud, and additional fittings are required to permit utilization of either clear water or the water and mud mixture in the jetting operation.

OR-14
APP-3-7-55

U.S. DEPARTMENT OF AGRICULTURE
SOIL CONSERVATION SERVICE

PIEZOMETER LOG FOR DRAINAGE INVESTIGATIONS

Property A. B. Doe Date 9-15-71
 Piezometer No. B-4 Elevation 3301.9
 Location Sec. 15-T21N.-R31E. Land Use Crop
 Surface Soil Clay Loam Elevation 3300.4
 Physiography Bench Relief Slope 0.003
 Length of Piezometer 9.0 Feet
 Height of Piezometer above Ground Surface 1.5 Feet
 Depth of Piezometer in the Ground 7.5 Feet
 Technician R. B. Roe

| | | | | | | | | | | | | | | | | | | | | | | |
|---|--|-------------------------------------|-------------------------------------|--------------------------|-------------------------------------|-------------------------------------|--------------------------|--------------------------|-------------------------------------|--------------------------|--|--|-------|-------|-------|------------|--------------|--------------------------|--------------------------|--------------------------|-------------------------------------|--------------------------|
| <p style="text-align: center;">DRIVING RESISTANCE</p> <p>H..... Hard M..... Moderate E..... Easy</p> <div style="display: flex; align-items: center;"> <div style="writing-mode: vertical-rl; transform: rotate(180deg); font-weight: bold; margin-right: 5px;">FEET</div> <div style="border-left: 1px solid black; border-right: 1px solid black; border-bottom: 1px solid black; padding: 5px;"> <p>0</p> <p>1</p> <p>2 E</p> <p>3</p> <p>4 EM</p> <p>5</p> <p>6</p> <p>7 M</p> <p>8</p> <p>9</p> <p>10</p> <p>11</p> <p>12</p> <p>13</p> <p>14</p> <p>15</p> <p>16</p> <p>17</p> <p>18</p> <p>19</p> <p>20</p> <p>21</p> </div> </div> | <p style="text-align: center;">PUNCHING RIVET FROM END OF PIEZOMETER (Resistance)</p> <table style="width: 100%; text-align: center;"> <tr> <td>Hard</td> <td>Moderate</td> <td>Easy</td> </tr> <tr> <td><input type="checkbox"/></td> <td><input checked="" type="checkbox"/></td> <td><input type="checkbox"/></td> </tr> </table> | Hard | Moderate | Easy | <input type="checkbox"/> | <input checked="" type="checkbox"/> | <input type="checkbox"/> | | | | | | | | | | | | | | | |
| | Hard | Moderate | Easy | | | | | | | | | | | | | | | | | | | |
| | <input type="checkbox"/> | <input checked="" type="checkbox"/> | <input type="checkbox"/> | | | | | | | | | | | | | | | | | | | |
| | <p style="text-align: center;">SOIL CONDITION AT END OF PIEZOMETER (Soil on End of Punch Rod)</p> <table style="width: 100%; text-align: center;"> <tr> <td>Dry</td> <td>Moist</td> <td>Wet</td> <td>Soupy</td> <td>Water</td> </tr> <tr> <td><input type="checkbox"/></td> <td><input type="checkbox"/></td> <td><input type="checkbox"/></td> <td><input type="checkbox"/></td> <td><input checked="" type="checkbox"/></td> </tr> </table> | Dry | Moist | Wet | Soupy | Water | <input type="checkbox"/> | <input type="checkbox"/> | <input type="checkbox"/> | <input type="checkbox"/> | <input checked="" type="checkbox"/> | <p style="text-align: center;">SOIL TEXTURE (Determined from Flushing Effluent)</p> <table style="width: 100%; text-align: center;"> <tr> <td>Clays</td> <td>Silts</td> <td>Looms</td> <td>Fine Sands</td> <td>Coarse Sands</td> </tr> <tr> <td><input type="checkbox"/></td> <td><input type="checkbox"/></td> <td><input type="checkbox"/></td> <td><input checked="" type="checkbox"/></td> <td><input type="checkbox"/></td> </tr> </table> | Clays | Silts | Looms | Fine Sands | Coarse Sands | <input type="checkbox"/> | <input type="checkbox"/> | <input type="checkbox"/> | <input checked="" type="checkbox"/> | <input type="checkbox"/> |
| | Dry | Moist | Wet | Soupy | Water | | | | | | | | | | | | | | | | | |
| | <input type="checkbox"/> | <input type="checkbox"/> | <input type="checkbox"/> | <input type="checkbox"/> | <input checked="" type="checkbox"/> | | | | | | | | | | | | | | | | | |
| Clays | Silts | Looms | Fine Sands | Coarse Sands | | | | | | | | | | | | | | | | | | |
| <input type="checkbox"/> | <input type="checkbox"/> | <input type="checkbox"/> | <input checked="" type="checkbox"/> | <input type="checkbox"/> | | | | | | | | | | | | | | | | | | |
| <p style="text-align: center;">RATE OF WATER SURFACE DROP IN PIEZOMETER (Following Flushing)</p> <table style="width: 100%; text-align: center;"> <tr> <td>Artesian</td> <td>Back Pressure</td> <td>Slow</td> <td>Moderate</td> <td>Rapid</td> </tr> <tr> <td><input type="checkbox"/></td> <td><input type="checkbox"/></td> <td><input type="checkbox"/></td> <td><input checked="" type="checkbox"/></td> <td><input type="checkbox"/></td> </tr> </table> | Artesian | Back Pressure | Slow | Moderate | Rapid | <input type="checkbox"/> | <input type="checkbox"/> | <input type="checkbox"/> | <input checked="" type="checkbox"/> | <input type="checkbox"/> | <p style="text-align: center;">REMARKS</p> <p><i>Piez. elev. top of pipe at elev. 3301.9</i></p> | | | | | | | | | | | |
| Artesian | Back Pressure | Slow | Moderate | Rapid | | | | | | | | | | | | | | | | | | |
| <input type="checkbox"/> | <input type="checkbox"/> | <input type="checkbox"/> | <input checked="" type="checkbox"/> | <input type="checkbox"/> | | | | | | | | | | | | | | | | | | |

Figure 2-10, Example of field sheet for piezometer log

Batteries of piezometers. - In areas where artesian pressures are suspected piezometers should be installed in groups of 2 to 4 piezometers of different lengths. The number of piezometers in each battery will be dependent on the variations in the subsoil profile. A piezometer should bottom out in each stratum of significantly different permeability. Where the subsoil materials are essentially the same at least two piezometers should bottom out at different depths in order to determine the direction of water flow.

Salinity of ground water

Drainage investigations in arid and semi-arid areas should include an investigation of salinity. It is assumed that in irrigated areas the quality of irrigation water is known. If not, the quality should be determined. Investigation of soil salinity was discussed on page 2-21. To supplement the information obtained by that investigation samples of ground water should be obtained and tested for total salt content. These may be obtained from the bore holes used to measure hydraulic conductivity. A small one-ounce sample bottle of water is adequate for the test.

Irrigation practices

Irrigation and agricultural practices, quality of irrigation water, precipitation, and salinity are the principal factors which determine the drainage coefficient in an irrigated area. The procedure for making the determination is discussed in detail in Chapter 4. Information needed includes precipitation records, knowledge of crops to be grown, quality of irrigation water, salinity of the soil, the amount of water to be applied each irrigation, the frequency of irrigation and an estimate of irrigation water losses. The leaching requirement, necessary to the maintenance of a favorable salt balance, must be included in the water to be drained but it is not considered a loss. It should be considered a necessary use of water. The amount of irrigation water applied and the frequency of irrigation can be obtained from farmer-rancher interviews. In district or corporation type enterprises this information can usually be obtained from the project manager's office. Data on the leaching requirement and deep percolation losses can be obtained from an analysis of crops grown and irrigation water quality and from consumptive use studies in the local area. Data on field ditch losses can be obtained from actual measurements made, or may be available from irrigation project records. Field ditch losses are usually minor and vary in the general range of five to ten percent of the field delivery. In the absence of data on ditch losses they can usually be estimated at about eight percent without introducing serious error.

Investigation of existing systems of buried drains

Investigation of old drain installations is sometimes necessary to determine feasibility of rehabilitating or adding them to other systems, or using them as outlets for new systems. Often, investigation of such drains is almost entirely a probing and digging operation.

Prior to making the field investigation, it is desirable that all possible sources of information on the old system be explored. These would include old construction plans, records and diaries, and the comments of knowledgeable inhabitants. Soil surveys, farm conservation plans, and aerial photographs may reveal information also. Aerial photographs taken after heavy rainfall or periods of high water may reveal the general location of the system through lighter coloring of drier soils immediately over the drains or differences in color or density of vegetative growth.

By use of metal probes, exact location of lines can be found and inspection pits opened up along the line, usually at about 500-foot intervals. From these locations, the depth, grade and size of drain, amount of silt and root growth in it, and the condition of drain material can be appraised. Need for additional inspection pits is determined from what appears to be wrong with the drain. Poor grade, such as high and low places in the drain, would require closer spacing of pits than would uniform deposits of silt. Surface sinks over lines are indicative of broken tile or excessive construction gaps between tile. Rising water in an inspection pit would indicate blocks in the drain further downstream. If a few openings show cracked or broken tile, enough tile must be uncovered to determine whether the line should be salvaged.

If silt deposits occupy a substantial part of the drain cross section and extend throughout much of the line, consideration should be given to cleaning the line or to replacing it. Accumulation of chemical deposits, such as iron and manganese oxides, in the drain and drain openings also may make a drain ineffective. It is usually cheaper to install a new drain than to dig up, clean, and relay an existing small line. However, salvage of drains may be accomplished by cleaning the drain in place with special jetting equipment. This equipment uses high velocity water jets from a nozzle on a high pressure hose inserted in the line from the outlet end to dislodge and flush silt and sludge from the drain. Treatment with sulfur dioxide gas may be needed for rehabilitation of drains affected by chemical deposits. See Chapter 4, page 121.

Sufficient amounts of soil are exposed in the process of establishing inspection pits to provide checks on soil texture and drain spacing requirements.

Observation of the type of drain failure also indicates cause of failure. For example, longitudinal breaks at quarter points on the circumference of a tile drain are indicative of expansion of freezing water in the line or excessive loading.

Thus, inadequacies of design are revealed from the location, depth, grade and size of drain and absence of essential auxiliary measures, such as silt traps, etc. Poor alignment, wavy profile, and defective drains reveal inadequacy of construction and materials. Presence of sink holes, filled silt traps, and surface washes over lines may indicate inadequate design, lack of suitable filter around the drain, poor construction, and inadequate maintenance. Filled and overgrown outlet channels reveal inadequate maintenance.

References

- (1) MARMER, H. A.
1951. Tidal Datum Planes. U. S. Coast and Geodetic Survey, Special Publication No. 135, U. S. Government Printing Office.
- (2) DRAINAGE OF IRRIGATED LANDS COMMITTEE, SW-234, AMERICAN SOCIETY OF AGRICULTURAL ENGINEERS.
1966. Guide for Investigation of Subsurface Drainage Problems on Irrigated Lands. Special Publication SP-04-66, American Society of Agricultural Engineers, St. Joseph, Michigan 49085.
- (3) SOIL SURVEY STAFF, USDA, SOIL CONSERVATION SERVICE.
1951. Soil Survey Manual, USDA Agriculture Handbook No. 18, U. S. Government Printing Office.
- (4) BOWER, C. A.
1963. Diagnosing Soil Salinity. U. S. Salinity Laboratory, Agricultural Research Service, U. S. Department of Agriculture, Agriculture Information Bulletin No. 279.
- (5) RICHARDS, L. A., BOWER, C. A., and FIREMAN, MILTON.
1956. Tests for Salinity and Sodium Status of Soil and of Irrigation Water. Circular No. 982, U. S. Department of Agriculture.
- (6) UNITED STATES SALINITY LABORATORY.
1954. Diagnosis and Improvement of Saline and Alkali Soils. Agriculture Handbook No. 60, U. S. Department of Agriculture.
- (7) DONNAN, W. W. and BRADSHAW, G. B.
1952. Drainage Investigation Methods for Irrigated Areas in Western United States. Technical Bulletin No. 1065, U. S. Department of Agriculture.
- (8) KIRKHAM, DON.
Measurement of the Hydraulic Conductivity of Soil in Place.
Journal Paper No. J-2505, Iowa Agricultural Experiment Station, Ames, Iowa, Project 998.
- (9) DRAINAGE RESEARCH COMMITTEE, SW-231, AMERICAN SOCIETY OF AGRICULTURAL ENGINEERS.
1962. Measuring Saturated Hydraulic Conductivity of Soils. Special Publication SP-SW-0262, American Society of Agricultural Engineers, St. Joseph, Michigan 49085.
- (10) LUTHIN, JAMES N.
1957. Drainage of Agricultural Lands. Vol. VII of Agronomy Monographs, American Society of Agronomy, Madison, Wisconsin.
- (11) KIRKHAM, DON.
1965. Saturated Conductivity as a Characterizer of Soil for Drainage Design. Journal Paper No. J-5310, Iowa Agricultural Experiment Station, Ames, Iowa. Conference Proceedings, Drainage for Efficient Crop Production, American Society of Agricultural Engineers, St. Joseph, Michigan 49085.

- (12) VAN BEERS, W. F. J.
1958. The Auger Hole Method. Bulletin 1, International Institute for Land Reclamation and Improvement, Wageningen, the Netherlands.
- (13) VAN BAVEL, C. H. M. and KIRKHAM, DON.
1948. Field Measurement of Soil Permeability Using Auger Holes. Soil Science Society of America Proceedings, Vol. 13, pp. 90-96.
- (14) SPANGLER, M. G.
1951. Soil Engineering. International Textbook Co., Scranton.
- (15) ERNST, L. F.
1950. A New Formula for the Calculation of the Permeability Factor with the Auger Hole Method. Agricultural Experiment Station, T.N.O. Groningen, the Netherlands. Translated from the Dutch by Herman Bouwer, Cornell University, Ithaca, N. Y., 1955.
- (16) BOUWER, HERMAN.
1962. Field Determination of Hydraulic Conductivity Above a Water Table with the Double-Tube Method. Soil Science Society of America Proceedings, Vol. 26, No. 4, July-August 1962.
- (17) UNITED STATES BUREAU OF RECLAMATION.
1963. Earth Manual. U. S. Department of the Interior, Bureau of Reclamation.
- (18) REGER, J. S., PILLSBURY, A. F., REEVE, R. C., and PETERSEN, R. K.
1950. Techniques for Drainage Investigations in Coachella Valley, California. Agricultural Engineering, Vol. 31, No. 11, pp. 559-564, November 1950, Journal of the American Society of Agricultural Engineers, St. Joseph, Michigan 49085.

APPENDIX A

TYPICAL OUTLINE FOR PRELIMINARY SURVEY

This typical survey outline illustrates the detail which is normally required for the engineering survey for development of a watershed work plan for a flat land watershed. The criteria listed is for illustration only, but it is typical for the following type of watershed:

1. Soils are slowly permeable. Permeability is generally less than 0.5 inch per hour.
2. Slopes are flat - less than four feet per mile.
3. The watershed is moderately well developed for agriculture. A large percentage is cultivated, with the rest in woodland, pasture, and miscellaneous.
4. Some drainage improvements have been made, but due to lack of organization and financing, maintenance has been neglected and the present drainage situation is poor.
5. Principal crops are rice, cotton, and soybeans.

OUTLINE FOR SURVEY
of the
CYPRESS BAYOU WATERSHED, SUTTON COUNTY
MIDDLESTATE
May 1971

I. Objectives:

- A. Determine extent of area needing flood prevention and drainage and adequacy of the outlet for desired improvements.
- B. Locate and design principal features of a flood prevention and drainage system which will remove within one day after cessation of rain the runoff from 48-hour, 2-year frequency storms.
- C. Estimate the quantities and costs of the improvements needed to meet the objective in B above.
 1. Break down the estimate into the part needed for group facilities (disposal system) and the part needed for on-farm improvements (collection system).
 - a. Group facilities should be extended to a minimum 160 acres drainage area, but not beyond the point where less than two landowners are benefited.
 - b. On-farm or collection system should include all facilities, other than those included as group facilities, which are needed to meet the objective listed above.

II. Data presently available:

(This is usually listed in the report of Preliminary Investigation. It is listed here as an example of the type of data which is useful on a survey of this type.)

- A. Aerial photographs, 1968 flight - 8"/mi. alternates and 3.167"/mi. consecutives (contact prints).

Complete coverage of the watershed.

B. Maps:

1. Sutton County Highway Map--scale 1/2 inch equals 1 mile.
2. U. S. Corps of Engineers quadrangle maps: DeQueen, 1954; Golden, 1941; Gilmer, 1935; and Vaness, 1935--scale 1/62,500--5' contour interval - complete coverage.
3. Cypress Bayou Watershed Map--scale 2 inches equals 1 mile.
4. Generalized soils map--Sutton County SCD--scale 1 inch equals 1 mile.
5. Approximately 60 percent coverage standard soil surveys.

C. Surveys:

1. U.S.C. & G.S., control leveling, first order--DeQueen West, Gilmer to DeQueen to Alton to Sanford, Sanford to Big Bayou, and Alton West.
2. U.S.C.E., BM data--DeQueen, Golden, Gilmer, and Vaness quadrangles.

D. Records and reports:

1. House Document No. ____, __th Congress 1st Session, Blue and Salt Rivers and Tributaries, Middlestate, 1967.
2. U.S.C.E. stream gage data--Big Bayou near Vaness, and at Big Bayou floodgate, U. S. Army Engineer District, Vicksburg.

III. Data to be developed:

- A. Land use and capability map.
- B. Drainage area map of watershed--to be added to Cypress Bayou Watershed Map. Watershed boundaries of all mains and laterals should be delineated.
- C. Project map of watershed--to show all principal features of the recommended plan of improvement.
- D. Land ownership map.
- E. Plans, profiles, cross sections, and other design data of all mains and laterals to be included in the plan of improvement.
- F. Design data for all appurtenant structures for mains and laterals and for other features of the plan of improvement for the watershed.

- G. Estimate of quantities and costs for all features of the plan.
- H. Report of the survey and investigation including recommendations and any information needed for work plan development. Data A - G inclusive to be attached as appendixes to the report.

IV. Proposed sequence of survey and investigation:

- A. From study of generalized and detailed soils maps and aerial photographs, determine land use, land capability, and area needing drainage.
 - 1. Information from standard soil surveys to be expanded to cover the watershed according to the generalized soils map and aerial photographs.
 - 2. Map to be prepared on Cypress Bayou watershed base map showing areas which will benefit from flood prevention and improved drainage. Tabulation of land use according to soils to be developed as basis for estimating benefits.
- B. By study of quadrangle maps and aerial photographs locate existing main ditches and principal laterals.
 - 1. Locate these on alternate contact-print aerial photographs. Identify each main stream or ditch by a Roman number. Also give each ditch its local name, if any. Number each lateral in a way which will identify it with its outlet.
- C. Locate, number, and give elevations of benchmarks within the watershed and vicinity on a county highway map. Data listed in IIC above to be included.
- D. Sketch watershed boundaries on the contact-print aerial photographs from data on quadrangle maps and aerial photographs. Check these boundaries on the ground as the survey progresses. Correct where necessary. Make a level survey where needed to delineate boundaries.
- E. Obtain data from U. S. Army Engineer District, Vicksburg, concerning outlet for Cypress Bayou into Big Bayou.
 - 1. From the Corps of Engineers study of water surface profiles - present and projected - for Big Bayou, for the two-year and five-year frequency storms, determine the adequacy of Big Bayou as the outlet for the proposed improvements.
- F. Establish additional temporary benchmarks (TBM's) on the North-South roads which are generally parallel to the main streams and along the east and west sides of the watershed. These TBM's are to be numbered and identified so they can be used in subsequent surveys.
 - 1. Locate TBM's at intervals of approximately 1 mile and at intersections with East-West roads.
 - 2. Close lines of differential levels with an allowable error of $\pm 0.05 \sqrt{\text{Length of line in miles}}$.

- G. Visually inspect all main and lateral ditch locations.
1. Estimate existing roughness coefficients of ditches which apparently have an adequate cross section.
 2. Check location of ditches previously sketched on aerial photographs - correct where necessary. Improve alignment as needed. Obtain necessary information on fences, irrigation flumes, dams, or any obstruction in the ditches which will affect the design or cost of the improvements. Record on aerial photographs or in notebook as required.
 3. Examine existing ditches for any evidence of instability - erosion or sedimentation.
 4. Estimate density and extent of clearing required for improving channel capacity.
 5. Locate and describe all utility lines crossing the ditches.
- H. Make a field survey.
1. Obtain cross sections of main ditches and laterals at intervals of approximately one mile; at major structures as bridges; where substantial changes in cross section or depth are evident; and below the entrance of all major tributaries. Take representative cross sections at each proposed realignment. Use the E - W roads to run levels to carry elevations from established TBM's to the locations selected for cross sectioning.
 2. Determine horizontal location of cross sections on mains and laterals by map wheel or scaling from aerial photographs. Measure from outlet upstream in miles to nearest hundredth. Cross sections must be accurately surveyed and located to be used with the design survey.
 3. Establish temporary benchmarks in strategic locations near the site of each cross section.
 4. Check previously located watershed divides, when running levels to obtain cross sections, and make corrections where needed.
 5. Determine the location, type, size, and condition of all bridges, culverts, and flumes on mains and laterals. Obtain cross sections, elevations of underside of stringers and bottom of footings, invert elevations of all culverts, and elevations of road surfaces at bridges and culverts. Information should be adequate to determine the adequacy of structure in its present condition or approximate cost of alteration or replacement if necessary.
 6. Determine high water elevations of main ditches and streams where possible.
 7. Obtain soil profile at each ditch cross section taken - - on mains to minimum depth of 10 feet; below intersection of Cypress and Muddy Bayous to minimum depth of 15 feet; and on all laterals to minimum depth of 6 feet. All depths given are below normal ground level.

- I. Plot existing cross sections and profiles of mains and laterals surveyed.
 1. For cross sections use horizontal and vertical scales of 1 inch equals 10 feet except for unusually large sections where a scale of 1 inch equals 20 feet, horizontally and vertically may be preferable. All sections should be located on cross-section sheet in the proper sequence. Scales used are to be clearly indicated. (Use 10 x 10 paper.)
 2. For profiles use a horizontal scale of 1 inch equals 2000 feet and a vertical scale of 1 inch equals 4 feet. (Use 4 x 20 paper.)
 3. On profiles show normal ground (low side), spot elevations and distances from ditch of control points, and existing ditch bottom. Plot the logs of soil borings. For structures plot the elevations of underside of stringers, roadbed, bottom of ditch under bridges or invert of culvert and bottom of structure footing. Give brief description of structures (as wood deck, concrete abutments, etc.) including size. Give type and estimate of riprap, if any.
- J. Complete location of mains and laterals on watershed map. Use corrected locations sketched on contact-print aerial photographs. Correct stationing as required. Add laterals and extend existing laterals to give coverage to watershed as outlined in ICla.
- K. Compute drainage areas at all cross-section locations.
- L. Determine rainfall excess - R_e - from a 2-year frequency, 48-hour storm and compute the C for the coefficient for surface drainage, $Q = CM^{5/6}$, by the relation $C = 16.39 + 14.75 R_e/2$.
- M. Compute capacity required at all cross-section locations based on the Cypress Creek Formula thus developed.
- N. Establish hydraulic gradelines for good drainage of the watershed, giving due consideration to water surface elevation of the outlet. (See Chapter 5).
- O. Complete design of drainage system.
 1. Check capacities of existing mains and laterals--including bridges and culverts--using the existing roughness coefficient. Evaluate the junctions of mains and laterals including the need for side inlet structures.
 2. Where existing sections are inadequate, compute the size required. Vary side slopes as required for stability, hydraulic efficiency and maintenance requirements. Proportion bottom widths and depth for best hydraulic efficiency, within requirements for channel stability.
 3. Based on soil characteristics determine stability of proposed channel by method of allowable velocities as prescribed in Engineering Standard for Open Channel, Code 582.
 4. Compute sizes of bridges and culverts which must be replaced. Design culverts to carry 25 percent more flow at the hydraulic grade line

than ditch is designed for. For bridge replacements, design bottom of stringers to be a minimum of one foot above the hydraulic grade line and the length to span the top width of proposed ditch.

- P. Plot the proposed sections superimposed on original cross sections and compute yardage of required excavation. Plot proposed bottom on profile. Add notes to profile concerning structure alterations or replacements necessary.
- Q. Estimate quantities and cost of the proposed improvement: clearing, clearing and shaping, channel excavation and disposition of spoil, bridges, culverts, grade stabilization structures, erosion control structures for side water inlets, watergates for cross fences, irrigation flumes, other appurtenant structures. Base estimate on current State standards and specifications.
- R. Estimate right-of-way required and show widths required by mile location on the profile sheet.
- S. Prepare report.
- V. Personnel required. Field work to start 10/4/71

| <u>Personnel</u> | <u>Dates</u> | | <u>Man Days</u> |
|---|---------------------|--------------|-----------------|
| Engineer GS-13 | 9/7/71 - 1/21/72 | | 4 |
| Engineer GS-12 | 9/7/71 - 1/21/72 | 2 days/month | 9 |
| Engineer GS-11 | 9/20/71 - 1/21/72 | 2 days/week | 36 |
| Engineer GS-9 (Field and office 50-50) | 9/27/71 - 1/7/72 | Full time | 75 |
| Geologist GS-9 | 11/22/71 - 12/17/71 | Full time | 20 |
| Aid GS-6 (Office) | 9/27/71 -- 1/7/72 | Full time | 75 |
| Aid GS-6 (Survey party) | 10/4/71 - 12/17/71 | Full time | 55 |
| Aid GS-5 (Survey party) | 10/4/71 - 12/17/71 | Full time | 55 |
| 2 Aids WAE (Survey party) | 10/4/71 - 12/17/71 | Full time | 110 |
| 2 Aids WAE (Geologist's helpers) | 11/22/71 - 12/17/71 | Full time | 40 |
| Complete field work | 12/17/71 | | |
| Complete plotting, design, and estimates | 1/7/72 | | |
| Complete report | 1/21/72 | | |

VI. Equipment. (Normally only equipment not on hand by the survey party will be listed. This list might be required to set up a new party.)

A. Automotive.

Pickup, equipped with trailer hitch, - Engineer GS-9

Station wagon - survey party

Truck w/power auger, fully equipped (See Guide to Geologic Site Exploration, South RTSC Area), Geologist GS-9

B. Boat and appurtenant equipment.

12-foot flat bottom aluminum boat on trailer

7-1/2 HP outboard motor

4 Life preservers

20ars - sounding weight - 200' steel wire, 11 ga.

C. Equipment for survey party.

1 Engineers' level, w/tripod and carrying case

2 - 14' Philadelphia level rods

1 - 100' steel tape

2 - 50' metallic tapes

1 - Tapewriter with aluminum tape

2 - Hand axes w/scabbards

2 - Pole axes, single bit

1 - 6-lb. sledge hammer

2 - Machetes w/scabbards

1 - Shovel, sharpshooter

6 - Aluminum hats, visor type

6 - pr. hip boots, (Lightweight, sizes to fit personnel)

Notebooks, pencils, lumber crayons, stakes, flagging material, 30d nails, water can, insect repellent, clip boards, carrying case for contact print aerial photographs, first aid kit, 10 pocket-type snakebite kits.

D. Office equipment.

1 - Drafting table, w/adjustable stool

1 - Calculator

1 - Slide rule

1 - Filing cabinet

1 - Desk and 10 chairs

2 - Tables

1 - Typewriter, with stand

Cross-section and profile paper, tracing paper, manila paper, pencils, writing paper, straightedges, triangles, engineers scales, scratch pads.

E. Books.

National Engineering Handbook

Surveying: Theory and Practice, 5th Edition - Davis, Foote, and Kelly

King and Brater's Handbook of Hydraulics, Fifth Edition

Tables, Trigonometric, Peters

Hydraulic Tables - Corps of Engineers

Technical Bulletin 129, USDA, Flow of Water in Drainage Channels.

Developed at:

Slippery Rock Junction,
Middlestate
July 1, 1971

By:

Tom Jones, Engineering Specialist
John Doe, Planning Party Engineer
Robert Roe, Area Engineer

Approved:

Sam Smith, Planning Party Leader

NATIONAL ENGINEERING HANDBOOK

SECTION 16

DRAINAGE OF AGRICULTURAL LAND

CHAPTER 3. SURFACE DRAINAGE

Contents

| | <u>Page</u> |
|---|-------------|
| General | 3-1 |
| Surface-drainage systems | 3-3 |
| The random system | 3-3 |
| The parallel system | 3-3 |
| The cross-slope system (diversion system) | 3-7 |
| Types and functions of surface-drainage ditches | 3-12 |
| Collection ditches | 3-12 |
| Disposal ditches | 3-13 |
| Land forming | 3-13 |
| Land smoothing | 3-15 |
| Land grading | 3-15 |
| Bedding | 3-16 |
| Land leveling | 3-18 |
| Joint surface and subsurface-drainage system | 3-18 |
| References | 3-22 |

Figures

| | | |
|-----------|---|------|
| Fig. 3-1 | Typical layout - individual farm-drainage system | 3-2 |
| Fig. 3-2 | Random system | 3-4 |
| Fig. 3-3 | Parallel system (sugarcane) | 3-5 |
| Fig. 3-4 | Parallel system | 3-6 |
| Fig. 3-5 | Cross-slope system on slight to moderate slopes | 3-8 |
| Fig. 3-6 | Cross-slope system on moderate to steep slopes | 3-9 |
| Fig. 3-7 | Cross-slope system on bottom land | 3-10 |
| Fig. 3-8 | Controlled surface water discharge into deep disposal ditch | 3-11 |
| Fig. 3-9 | Comparative profiles of land surface graded for drainage and one leveled for irrigation | 3-11 |
| Fig. 3-10 | Methods of grading surfaces for drainage | 3-14 |
| Fig. 3-11 | Bedding | 3-17 |
| Fig. 3-12 | Typical drainage system for irrigated land | 3-19 |
| Fig. 3-13 | Drainage and subsurface irrigation for improved pasture | 3-20 |
| Fig. 3-14 | Typical layout - individual rice farm, irrigation and drainage system | 3-21 |

General

Surface drainage is the orderly removal of excess water from the surface of land through improved natural channels or constructed ditches and through shaping of the land surface.

Surface drainage applies primarily on flat land where slow infiltration, low permeability, or restricting layers in the soil profile, or shallowness of soil over rock or deep clays, prevent ready percolation of rainfall, runoff, seepage from uplands, or overflow from streams through the soil to deep stratum. The land surface to be drained should have a continuous fall to the field ditch and the field ditch should have a continuous grade to the field lateral. The water surface in the field lateral at design depth should be low enough to drain the field.

Surface drainage systems, when properly planned, eliminate ponding, prevent prolonged saturation, and accelerate flow to an outlet without siltation or erosion of soil (1). In some cases, orientation of crop rows with the land slope may accomplish this purpose. In other cases, use of a diversion or a complete system of ditches and crop row drains is necessary as shown in figure 3-1. Combinations of both surface and subsurface drainage, such as land grading and smoothing over subsurface drains, often provide better and more economical results.

Surface drainage systems include both collection and disposal ditches. Where the system, or parts of the system, primarily collect and remove surface water from a field or small land area, the cross section, slope, pattern and spacing of ditches are essential factors of design as covered herein. Ditches for surface drainage are usually designed to remove the runoff produced by an ordinary rain in time to prevent damage to the crops grown in the drainage area.

The rate of removal is called the drainage coefficient which is the rate of water removal per unit area used in drainage design. For surface drainage the coefficient is usually expressed in terms of flow rate per unit of area, which varies with the size of the area. Where the drainage system or parts of the system primarily convey discharge from one or more fields, farms or large land areas to an outlet, the depth, capacity and hydraulic gradeline are added factors of consideration. Drainage coefficients for surface drainage and design of the ditches of the disposal system are covered in chapter 5, "Open Ditches - Design, Construction, and Maintenance."

Wide variations in climate, topography, soils, crops and farming practices between regions of the United States alter surface-drainage requirements. Therefore, when planning and designing surface-drainage systems, reference should be made to state handbooks and local drainage guides.

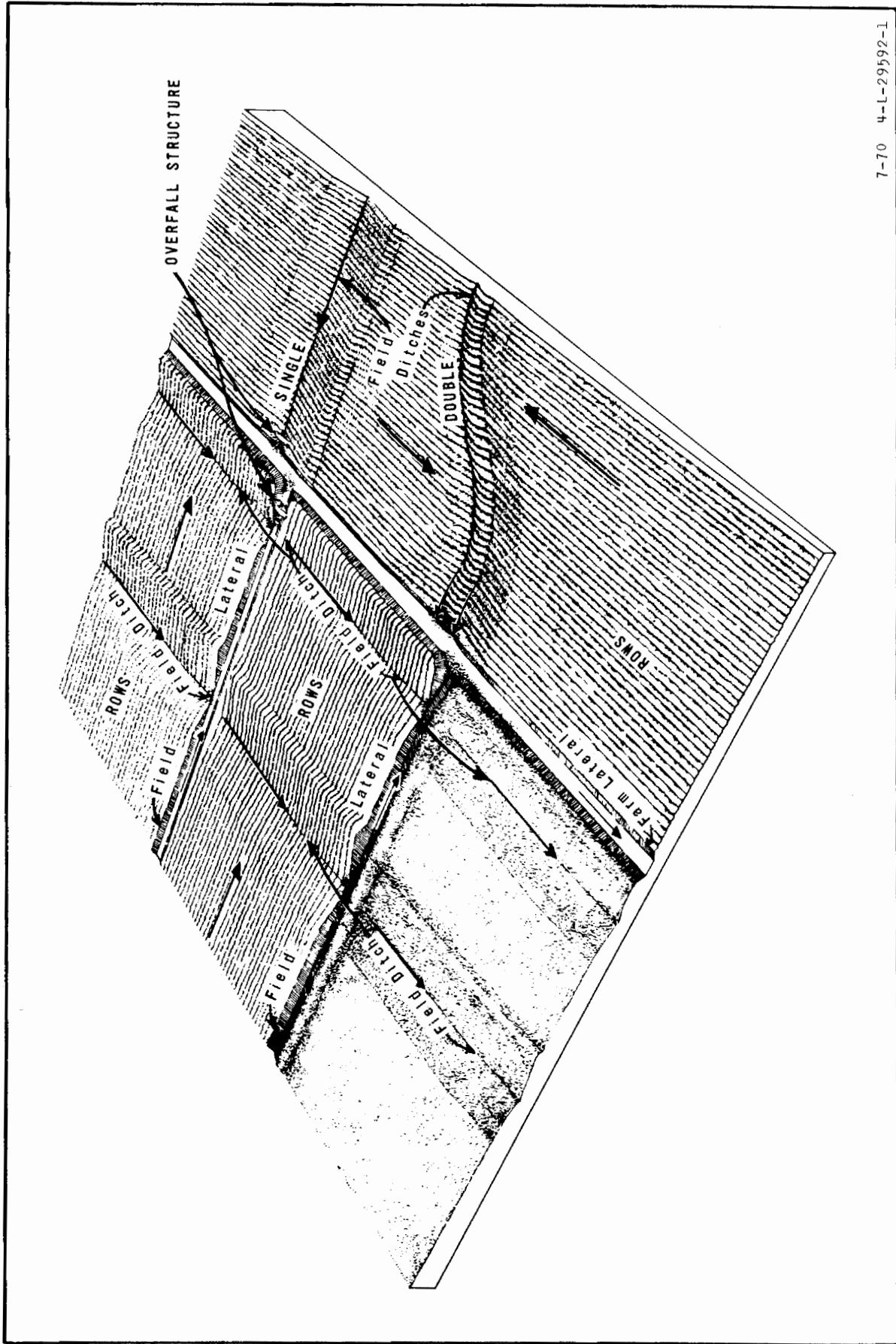

7-70 4-L-29592-1

Figure 3-1, Typical layout - individual farm drainage system
(Where the ground surface is undulating, ditches and drains will meander)

Surface-Drainage Systems

The basic surface-drainage systems are the parallel, the random, and the cross-slope or diversion system. The system to be used will depend upon the requirements of the site. The system used should --

1. Fit the farming system.
2. Cause water to flow readily from land to ditch without harmful erosion or deposition of silt.
3. Have adequate capacity to carry the flow.
4. Be designed for construction and maintenance with appropriate equipment locally available.

The random system

Where the topography is irregular, but so flat or gently sloping as to have wet depressions scattered over the area as shown in figure 3-2, a random system is used. The field ditches should be so located that they will transect as many depressions as feasible along a course through the lowest part of the field toward an available outlet. The course should be selected so as to provide the least interference with farming operations and a minimum of deep earth cuts. Cuts over three feet should be avoided although these sometimes are necessary to reach an outlet and leave a farmable field. Field ditches should ordinarily not be shallower than one-half foot deep or deeper than one foot where they are to be crossed frequently by farming equipment. Side slopes for handling farm equipment should be determined from local guides. Ditches should extend completely through depressions, as shown in figure 3-2, to assure complete drainage. Land grading, smoothing or bedding will usually be necessary on the less permeable soils to assure complete surface water removal.

The parallel system

Where topography is flat and regular, and a random system is impractical or inadequate, field ditches should be established in a parallel but not necessarily equidistant pattern as shown in figures 3-1, 3-3, and 3-4. Orientation of field ditches will depend upon direction of land slope; location of diversions, cross-slope ditches and mains and laterals of the disposal system; and access of the established lands to farming equipment. Usually, field ditches should run parallel to each other across a field to discharge into field laterals bordering the field. Laterals and mains should be deeper than the field ditches to provide free outfall. Surfaces of lands should be graded and smoothed for uninterrupted flow along crop rows or over the land surfaces, when rows are not maintained.

When soils are permeable and the field ditches will dry out in about the same time as the adjoining land surface, crop rows may be run across the field ditches so that they can collect and carry the row water directly to field laterals.

When crop rows are established parallel to field ditches, row ditches must be planned to drain rows through depressions and to reduce row lengths. Such ditches are temporary installations and are cut by hand shovel or plow during the course of farming operations.

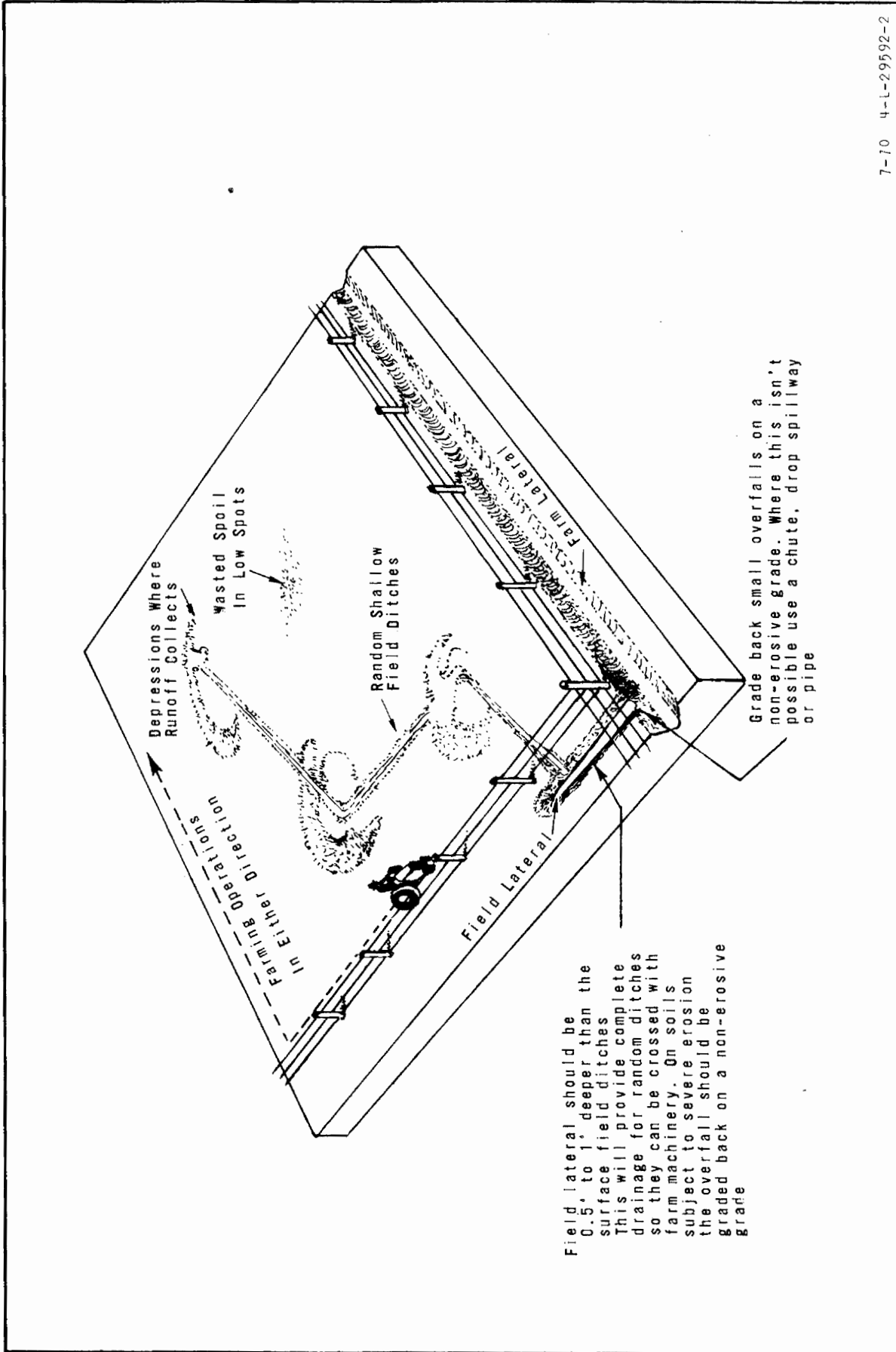

7-70 4-L-29592-2

Figure 3-2, Random system

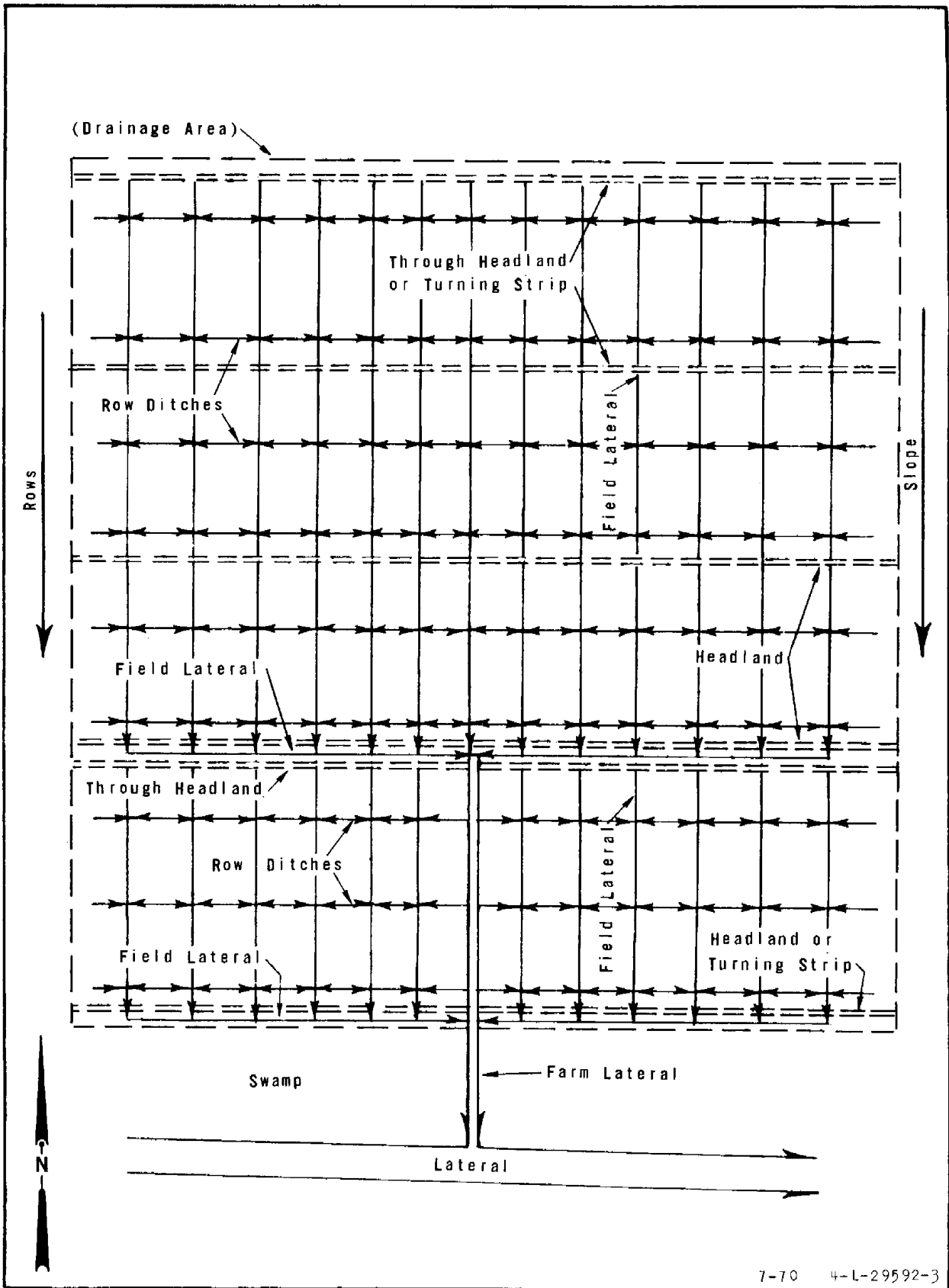

7-70 4-L-29592-3

Figure 3-3, Parallel system
(Illustrates field layout well suited to sugarcane)

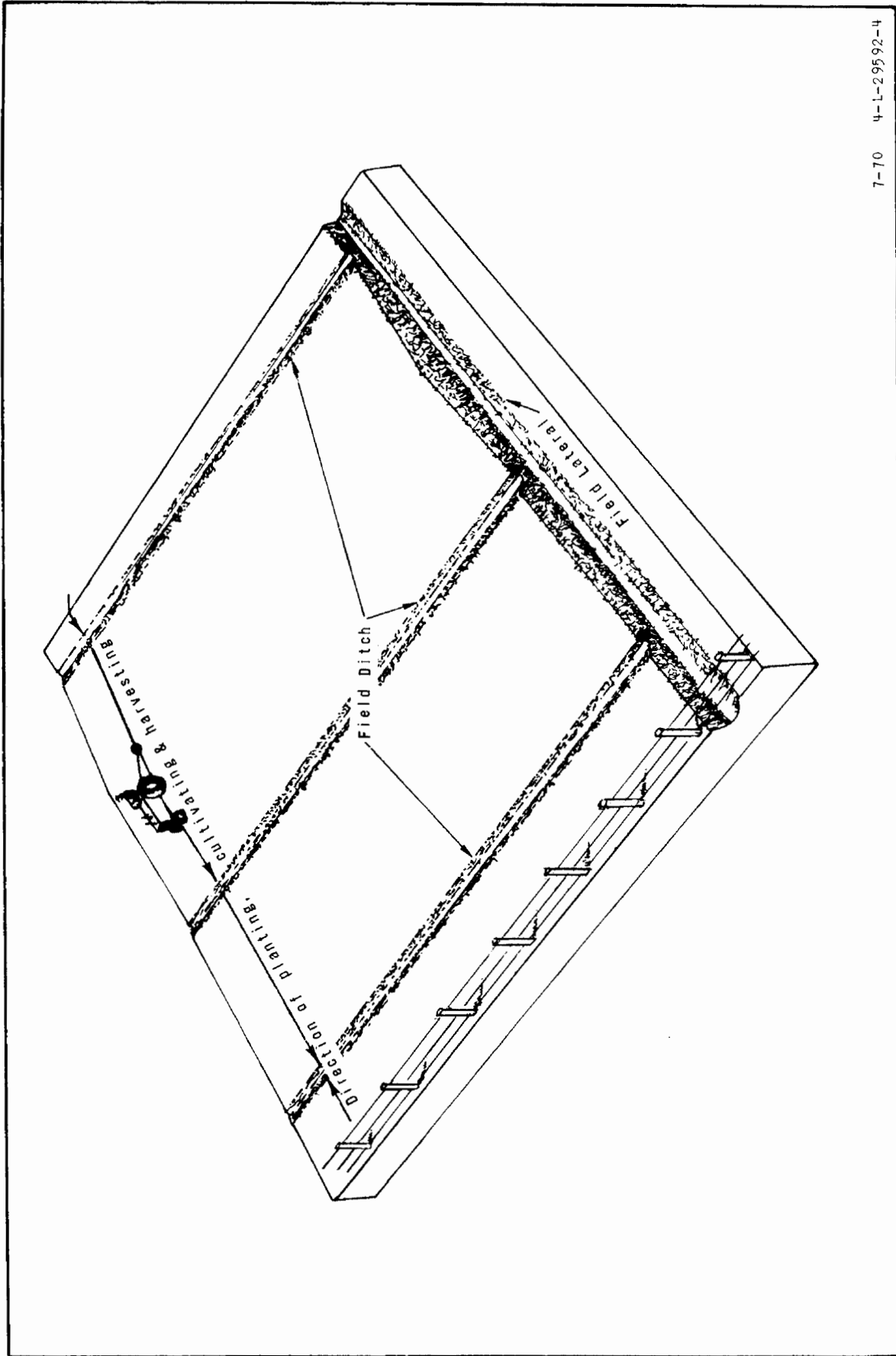

7-70 4-L-29592-4

Figure 3-4, Parallel system
(Illustrates field layout suited to growing a variety of row crops, including cotton, corn, soybeans, sugarcane, grain sorghum, etc.)

Spacing of parallel field ditches depends upon size of lands that can be tilled and harvested economically, on water tolerance of crops, and on the amount and cost of the necessary land forming. These factors must be determined locally. Where subsurface drainage may be used in conjunction with field ditches for protection of crops highly sensitive to water, such as tobacco, field-ditch spacing may need to be adjusted to be compatible with spacing requirements of the subsurface drains. Field-ditch spacing also should be adjusted to accommodate tillage and harvesting equipment to be used in the field.

The cross-slope system (diversion system)

Use the cross-slope system (a) to drain sloping land that may be wet because of slowly permeable soil, (b) to prevent the accumulation of water from higher land, and (c) to prevent the concentration of water in shallow pockets within the field. This system consists of one or more diversions, terraces, or field ditches built across the slope. As water flows downhill--either in the furrows between rows on cultivated land, or as sheet flow on hay land and permanent grassland--it is intercepted and carried off (figure 3-5).

Whether to use diversions or field ditches depends on the steepness of the slope, the permeability of the soil, and the possibility of water flowing from higher land onto the field being drained. Field ditches are best on slopes under two percent. Diversions apply to steeper land. Diversions also shorten long slopes where overtopping of field ditches would create an erosion hazard (figure 3-6).

The cross-slope system also prevents accumulation of water at the ends of long rows or at the lower edges of a field. It may be necessary to build field ditches to collect water from the furrows between the rows along the edge of spoil paralleling large mains and laterals. See figure 3-8.

Use local drainage guides to determine spacing and slope. Normally, erosion-control requirements determine spacing and design of terraces and diversions. Space the channels to control erosion. Design diversions to carry runoff from a 10-year frequency storm, plus freeboard. Where subsurface seepage is a problem, try to locate the channel so as to provide continuous interception of the seep line.

Where the field joins bottom land, use a field ditch (or lateral where several farms or large areas are involved) on the bottom land at the toe of slope. Where occasional overflow of bottom land is permissive, design the ditch capacity for the applicable drainage coefficient. Prevent unnecessary overflow by embankment of the spoil upon the bottom land side of the ditch (figure 3-7). Where shallow surface soils are underlain by slowly permeable soil, make the channels deep enough to intercept any subsurface flow that moves downhill above the tight layer. Spoil should be placed so that the ditch will hold as much water as possible in order to prevent unnecessary overflow.

Build the channels so that they have side slopes of 6 to 1 or flatter or as recommended in local guides if they are to be crossed regularly in farming operations. Blade the spoil to the lower side of the channel to form a low, wide ridge. On land to be kept in permanent vegetation, shape the channels and ridges so that vegetation can be established and mowed conveniently.

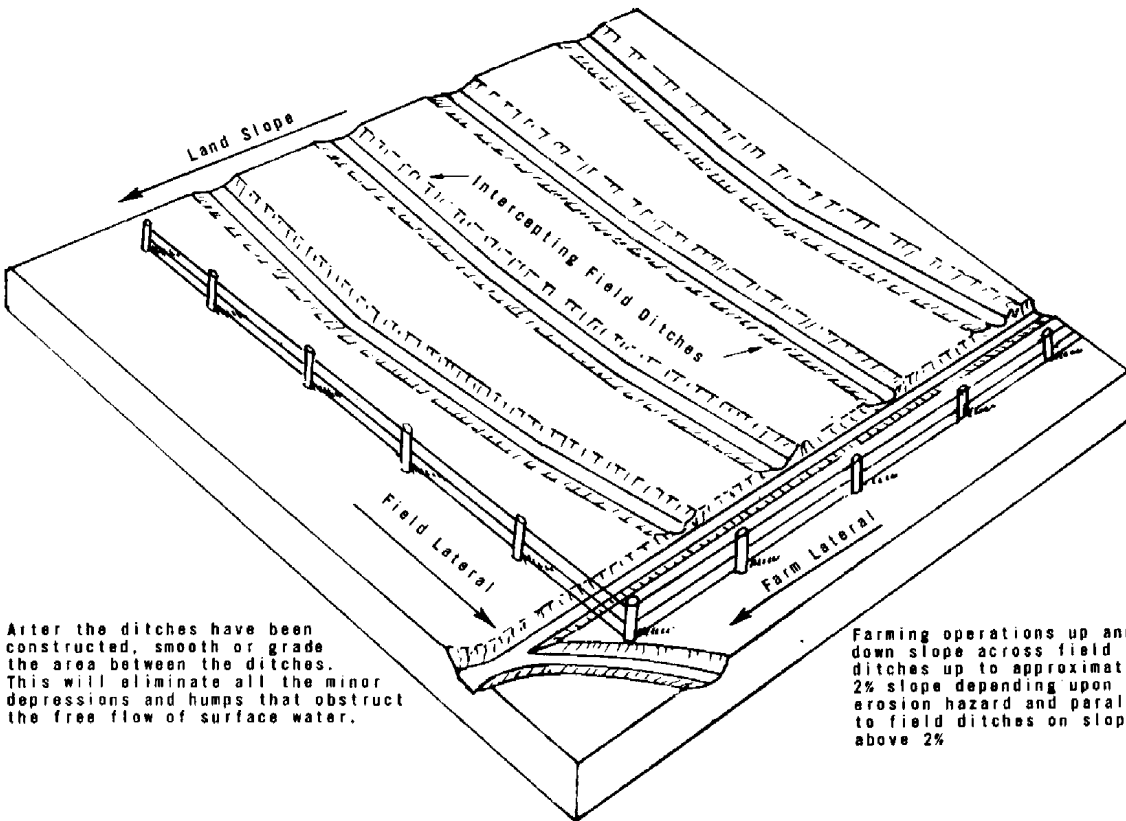

After the ditches have been constructed, smooth or grade the area between the ditches. This will eliminate all the minor depressions and humps that obstruct the free flow of surface water.

Farming operations up and down slope across field ditches up to approximately 2% slope depending upon erosion hazard and parallel to field ditches on slopes above 2%

TYPICAL FLAT BOTTOM SECTION

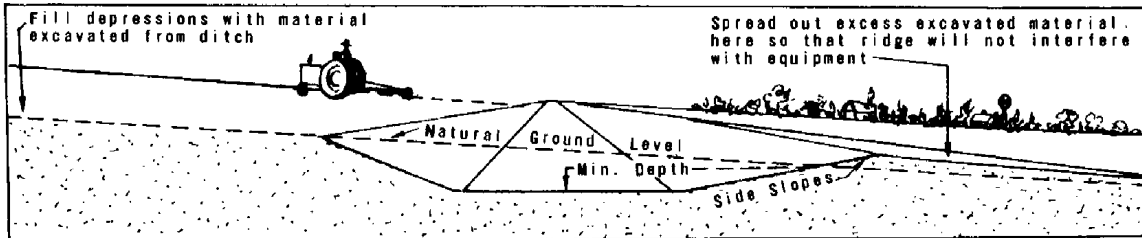

TYPICAL V-CHANNEL SECTION

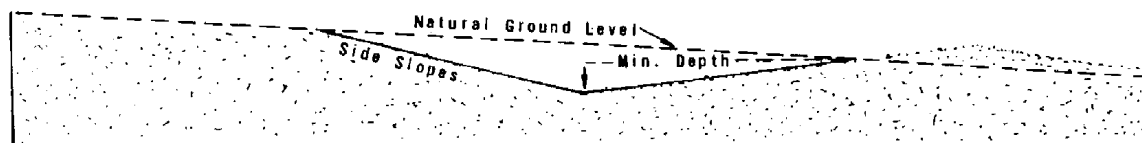

7-70 4-L-29592-5

Figure 3-5, Cross slope system on slight to moderate slopes

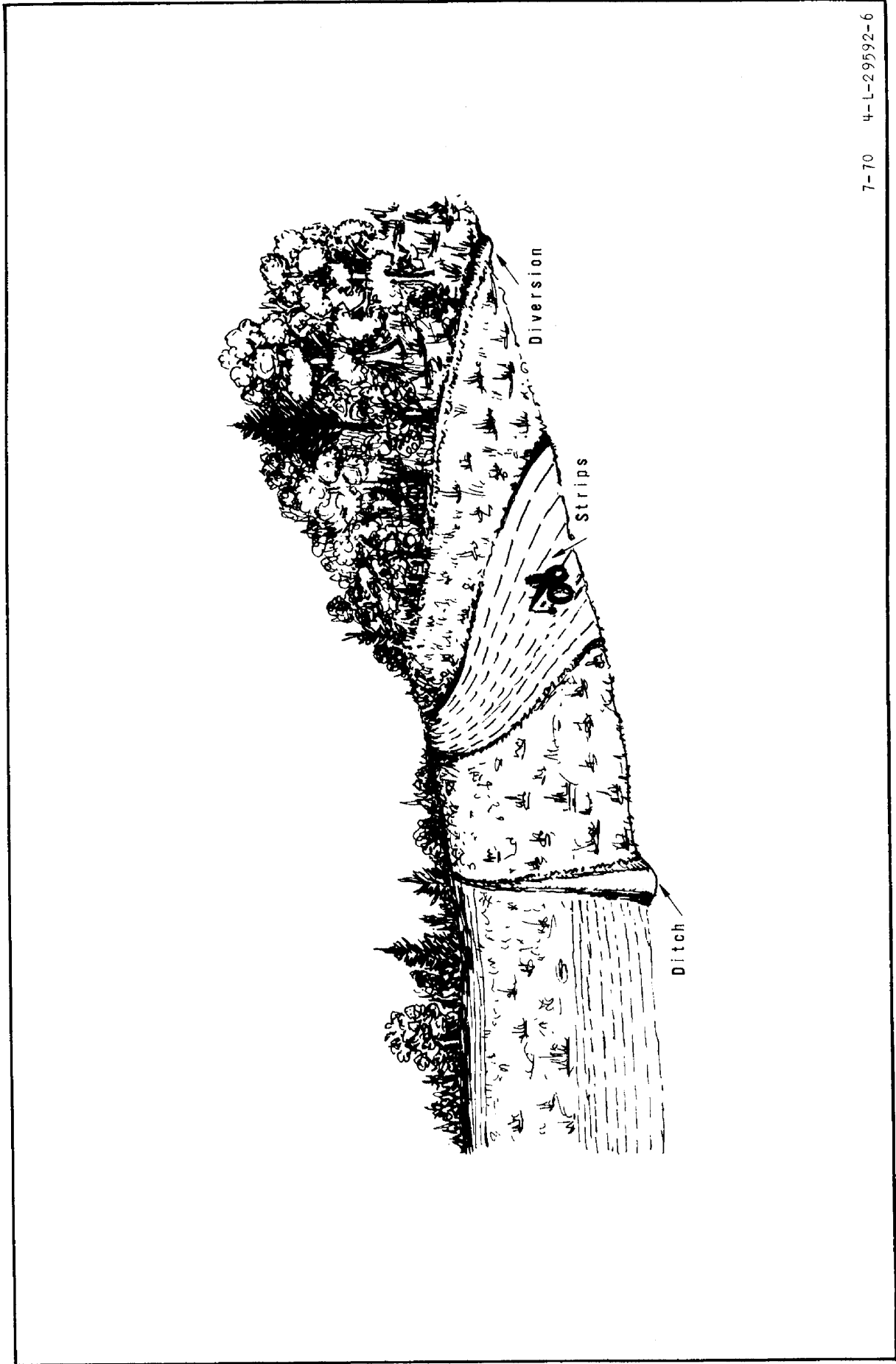
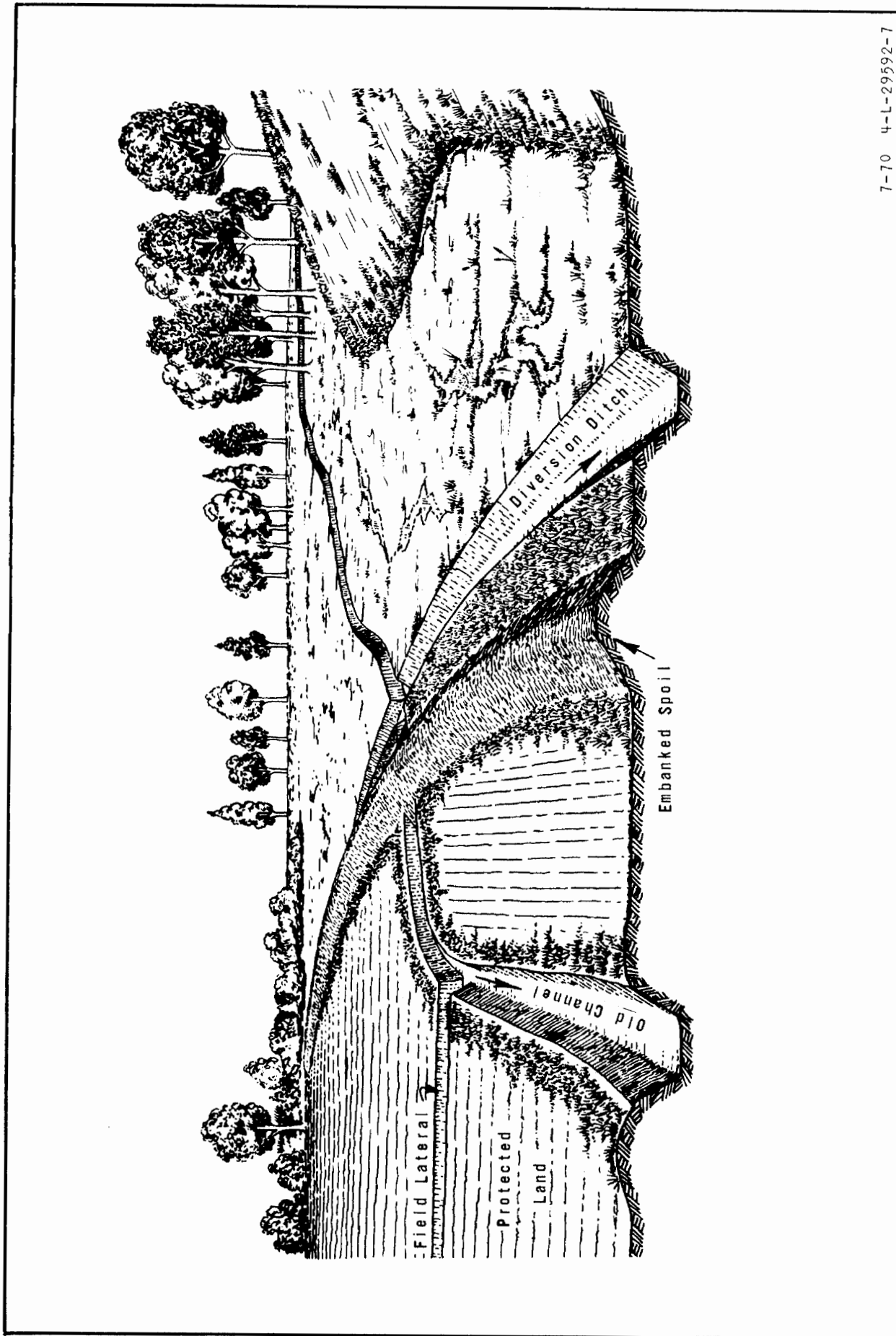

Figure 3-6, Cross slope system on moderate to steep slopes



7-70 4-L-29592-7

Figure 3-7, Cross slope system on bottomland

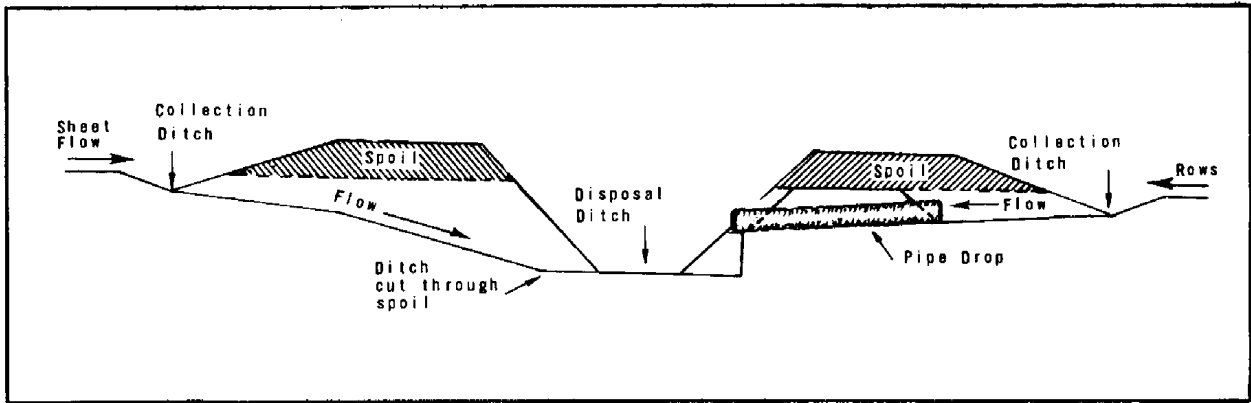
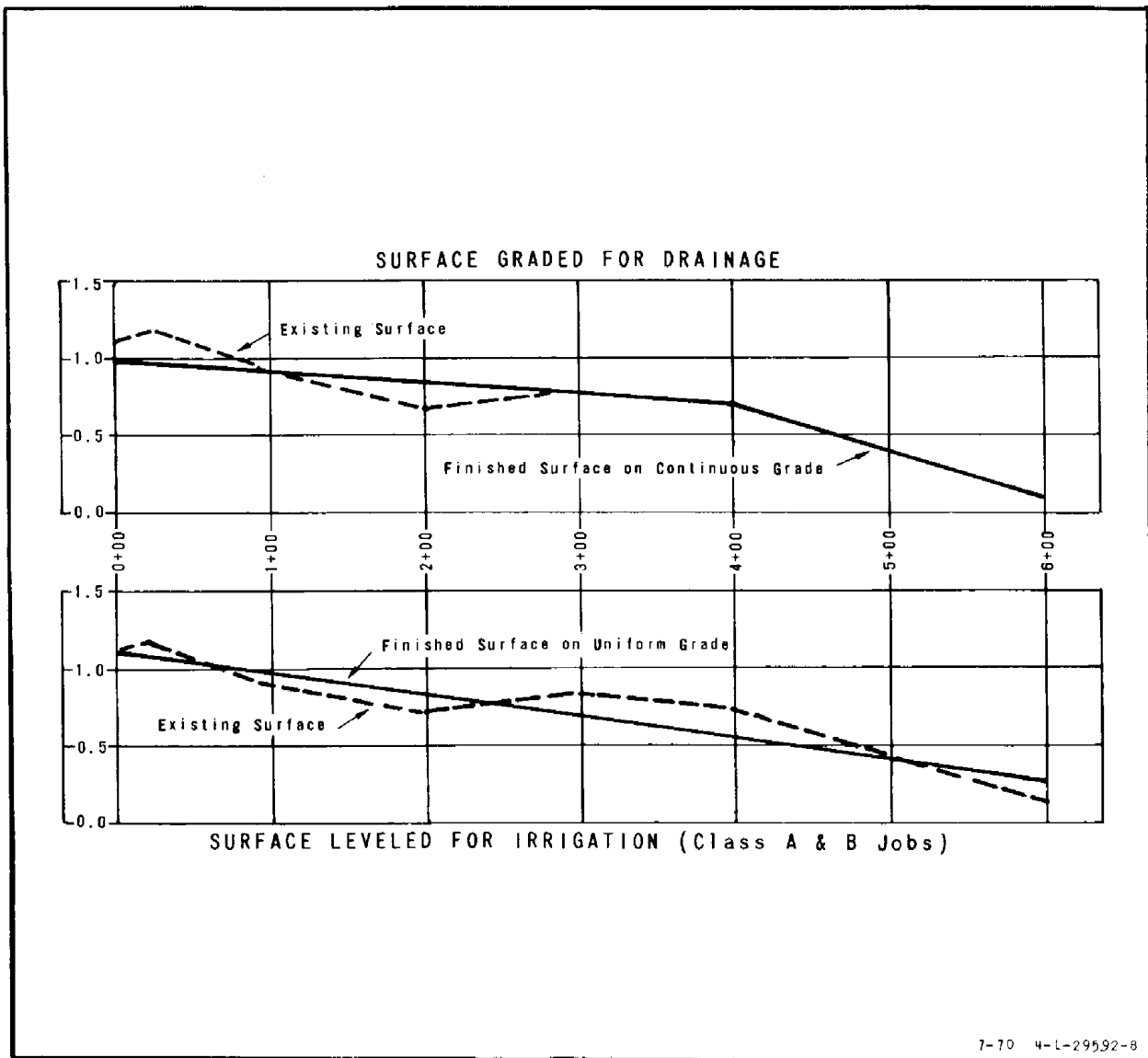

Figure 3-8, Controlled surface water discharge into deep disposal ditch



7-70 4-L-29592-8

Figure 3-9, Comparative profiles of a land surface graded for drainage and one leveled for irrigation

For small drainage areas, especially those subject to sheet flow, the parabolic or V-type channel is adequate. On larger drainage areas, use the flat-bottom channel.

Channels must be designed to meet requirements of the job without causing significant aggradation or degradation of the channel bed or erosion of the channel banks. Refer to Chapter 5, Open Ditches, for design criteria.

To assure good drainage on slowly permeable soils, run rows up and down the slope and across the ditch on land slopes up to about two percent or to such nonerosive slope limit as determined from local guides. Above such slope limits run rows parallel to cross-slope ditches or diversions.

Types and Functions of Surface-Drainage Ditches

Surface-drainage ditches function either as collection ditches and/or disposal ditches. Each ditch, whether individually or as a part of a system, must be located and shaped so as to accomplish its particular function.

Collection ditches should be located so water will flow naturally into them. To prevent erosion of the ditches by water entering over their sides, make them shallow, with flat side slopes, and protect them by vegetation or mechanical means, particularly when excavated in erodible soils.

Ordinarily, the location of disposal ditches--such as mains and laterals--has fewer restrictions than that of collection ditches. If there are only a few possible outlets, the chosen one will influence the location of disposal ditches. These ditches usually are deeper than collection ditches. Shaping or spreading spoil adjacent to disposal ditches does not seriously affect drainage, but for best land utilization and maintenance, spoil should be shaped, except in wooded areas or where the shaping of sterile subsoils would damage good land. Spoil should be spread in a manner that will allow efficient farming and maintenance operations.

Collection ditches

Field ditches collect water within a field. Their alignment, shapes, and capacities must fit the topography, drainage area, and principal land use of the field. See figures 3-1 and 3-2. Collection ditches should be installed with sufficient depth, width, and flatness of side slopes to allow tillage equipment to open furrows which will drain freely into the ditch.

Furrows

The furrow between the rows is the first collector of water in the drainage system of a row-cropped field. Rows should be so directed that water can move along them without ponding or scouring. Surface-field ditches must be arranged to provide drainage of row furrows. If the row system is a part of a furrow irrigation system, the location of surface field ditches may be determined by the requirements for irrigation.

Row gradient must vary according to topography, soils, and location, but rows should be continuous and should not be on erosive grades.

Row ditch

This is a temporary ditch for collecting water from the furrows between the rows. It is used primarily in parallel and bedding systems for crops having low water tolerances. It may be known locally as a "cross," "quarter," annual

ditch or "header ditch." Row ditches are cut directly across the row system to prevent ponding in slight depressions. See figure 3-3. Row ditches can be made by small plows, since they are no deeper than the crop rows. They are short, usually not more than 300 feet, and they can be open at both ends to discharge into field ditches.

Field ditch

This is a shallow, graded ditch for collecting water within a field, usually constructed with flat side slopes for ease of crossing. It may drain basins or depressional areas, collect or intercept flow from land surface or channeled flow from natural depressions, plow furrows, crop-row furrows, and bedding systems. State Drainage Guides and Standards and Specifications contain criteria regarding side slopes, grades, spacing and depth of drainage field ditches.

Disposal ditches

Disposal ditches are laterals and mains which transport the collected water to an outlet. Design should be according to principles set forth in chapter 5, "Open Ditches." Except for the field lateral, which is frequently a V-type channel, laterals and mains are usually trapezoidal. A lateral or main must be deep enough to handle the water from all the collection ditches that enter it.

Excavated material from disposal ditches should be used as fill for low areas, used for grading or leveling field surfaces, spread to permit unrestricted drainage, or placed in shaped spoil banks parallel to the ditch. Disposal ditches should have a flat berm along the bank edge. Its dimensions should be in accordance with recommendations of local drainage guides. See figures 3-2, 3-4, 3-5, 3-8, and 3-10.

Field lateral

Lateral ditches may have relatively steep side slopes since there is no need to allow for water coming over the sides. Shaped spoil along each bank of the ditch protects the ditch sides against damage by surface water. If the ditches are to be maintained by mowing, side slopes should not be steeper than 3 to 1. Usually, a grader is used in the construction of V-type laterals and backhoes or draglines for trapezoidal laterals.

Farm laterals and mains

A trapezoidal ditch should be used where the flow of water will be large. Since this type of ditch usually is at least three feet deep, provisions must be made for the entry of water from shallow field ditches and field laterals. As illustrated in figure 3-8, nonerosive discharge from collection ditches is obtained by means of (a) a nonerosive grade from the outlet of the collection ditch to the bottom of the lateral or ditch; (b) a length of pipe through which the water may be dropped safely to the lower elevation in the lateral or main; or (c) a standard drop structure.

Land Forming

Mechanically changing the land surface in order to drain surface water is known as land forming. It may be done by smoothing, grading, bedding, or leveling. Any of these methods, properly used, will result in better surface drainage.

TYPICAL CROSS SECTION OF GROUND SURFACE THAT HAS SOME GENERAL SLOPE IN ONE DIRECTION AND IS COVERED WITH MANY SMALL DEPRESSIONS AND POCKETS

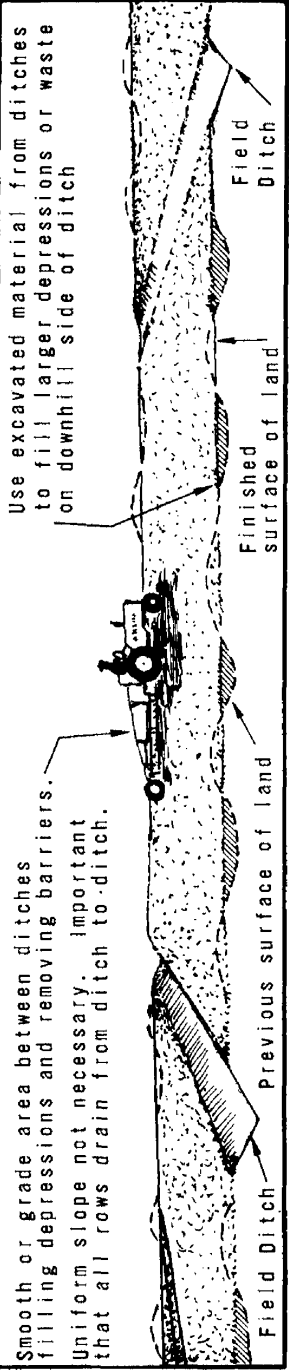

TYPICAL CROSS SECTION OF GROUND SURFACE THAT HAS LITTLE OR NO GENERAL SLOPE AND IS COVERED WITH MANY SMALL DEPRESSIONS AND POCKETS

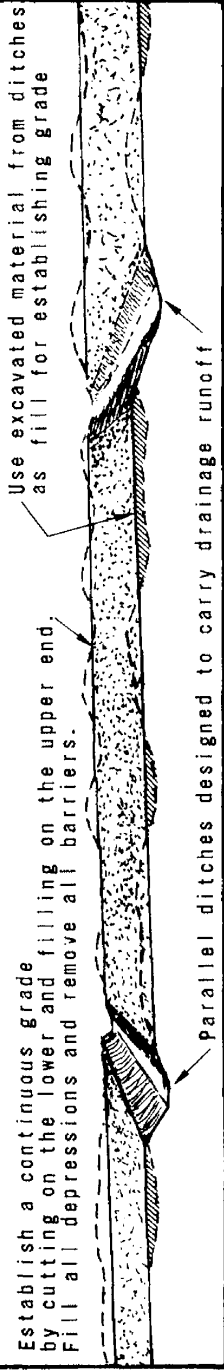

Establish a continuous grade to a developed ridge midway between field ditches by cutting from ditches and filling toward center of land between ditches.

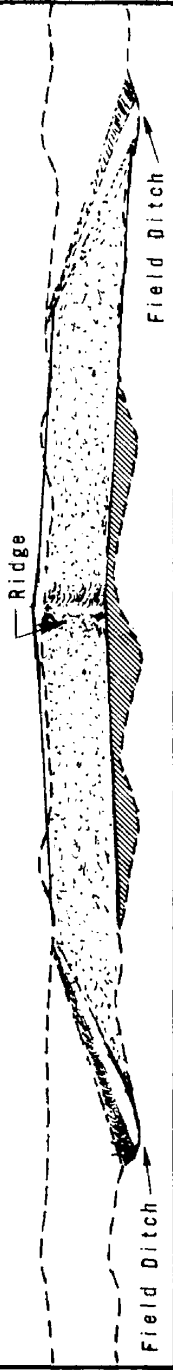

TYPICAL CROSS SECTION OF GROUND SURFACE THAT HAS LITTLE OR NO GENERAL SLOPE AND IS COVERED WITH MANY SMALL DEPRESSIONS AND POCKETS

Figure 3-10, Methods of grading land surfaces for drainage

Land smoothing

Shaping land to a smooth surface is important to good surface drainage. Land smoothing does not change the general contour of the land but it eliminates minor differences in field elevation including shallow depressions. Thus, better drainage can be obtained with fewer ditches. This in turn permits more efficient operation of farm equipment, reduces the cost of ditch maintenance, and reduces ice crusting.

Soils to be smoothed must have a profile which will allow small cuts without exposing layers that will hinder equipment operation or plant growth. Usually, land with slowly permeable surface soils and slopes less than about one-half of one percent should be graded prior to smoothing.

High spots and low spots are usually visible without the aid of an engineer's level. Only minor surveys and planning are necessary. Land planes used in land leveling and grading also are used for land smoothing.

Land grading

Land grading for drainage consists of shaping the land surface by cutting, filling and smoothing to planned continuous surface grades as shown in figure 3-9. The purpose of establishing continuous surface grades is to make sure that runoff water does not pond. Land grading for drainage does not require shaping of the land into plane surfaces with uniform slopes.

Emphasis in planning is given in filling depressions with soil from adjoining ridges and mounds. If an excessive amount of filling is required for low places, or if sufficient soil is not readily available, field ditches can be installed and the surfaces warped toward them. By establishing grade in the direction of row development or tillage, and developing cross-slope drainage only when advantageous, required cuts and fills can be held to a minimum. Methods of design and layout as given in Chapter 12, Section 15, Irrigation, SCS National Engineering Handbook, can be used for land grading. State standards for land grading will specify grades allowed.

In areas with little or no slope, grades can be established or increased by grading between parallel ditches with cuts from the edge of one ditch and fills toward the next. See figure 3-10. Surface ridging similar to bedding can be established by shaping and smoothing land surfaces and ditch spoil between closely spaced and graded field ditches, as shown in figure 3-10. The artificial ridge is created midway between the ditches. Approximately parabolic convex surfaces are developed by shaping from the ditch shoulders toward the ridge. Necessary crown height and fill are obtained by adjustment in spacing between ditches, flattening of ditch side slopes, and use of ditch spoil. Ditch spacing and crown heights are established in state handbooks and local guides.

Row length

Maximum permissible row lengths on graded land will vary according to soil permeability and grade and should be specified in local drainage or technical guides.

Row gradient

Row grades on nonplastic, permeable, but easily erodible soils should not exceed 0.5 percent. On plastic and slowly permeable soils with limited row

lengths, grades may reach a maximum of 2.0 percent. Limits should be specified in local drainage or technical guides.

Bedding

Bedding resembles a system of parallel field ditches with intervening lands shaped to a convex surface.

The beds are made by plowing, blading, or otherwise elevating the surface of flat land into a series of broad, low ridges separated by shallow, parallel dead furrows or ditches.

Bedding provides improved surface drainage by establishing adjoining parallel beds of lands running in the direction of the available natural slope, or if there is no slope, in the direction of the nearest outlet. This accomplishes one or more of the following: minimizes water pondage, provides gradients for removing runoff and permits efficient operation of tillage and harvest equipment.

The bedding practice has two distinct forms:

1. Lands or corrugations. In this type of bedding the convex area which is formed by plowing or blading lies between two dead furrows which are usually spaced from 30 to a maximum of 80 feet apart. These lands or corrugations require establishment of field ditches and laterals for collection and removal of runoff from dead furrows. See figure 3-11.
2. Crowning.--In this type of bedding operation the convex area is usually greater than 60 feet in width. Surface slopes are provided across each crown. The side boundaries of each crown are formed by some type of surface ditch. The crown is constructed with blade equipment. In figure 3-3, the area between the field laterals that run north and south would be the crowned area.

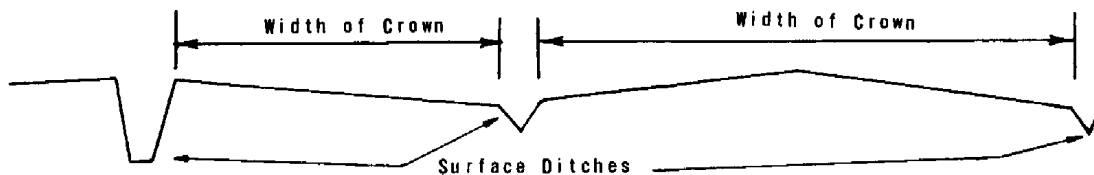

TYPICAL SURFACE PROFILE AFTER CROWNING

Lands and corrugations do not lend themselves to the most efficient operation of large, modern farming equipment and generally are used on poorly drained flat lands devoted to grass.

Crowning is usually used on land devoted to sugarcane, or sugarcane in rotation with other crops or grassland. In some areas this system is used for truck crops and other row crops. The crop rows are parallel with the crown length. The use of this system--figure 3-3--is declining in favor of land grading and use of a drainage system requiring fewer ditches--figure 3-4 (2).

The surface runoff from crop rows on all types of bedding is drained to the dead furrows or ditches by shallow row ditches cut across low places in the beds or at regular intervals. The dead furrows or ditches between beds are

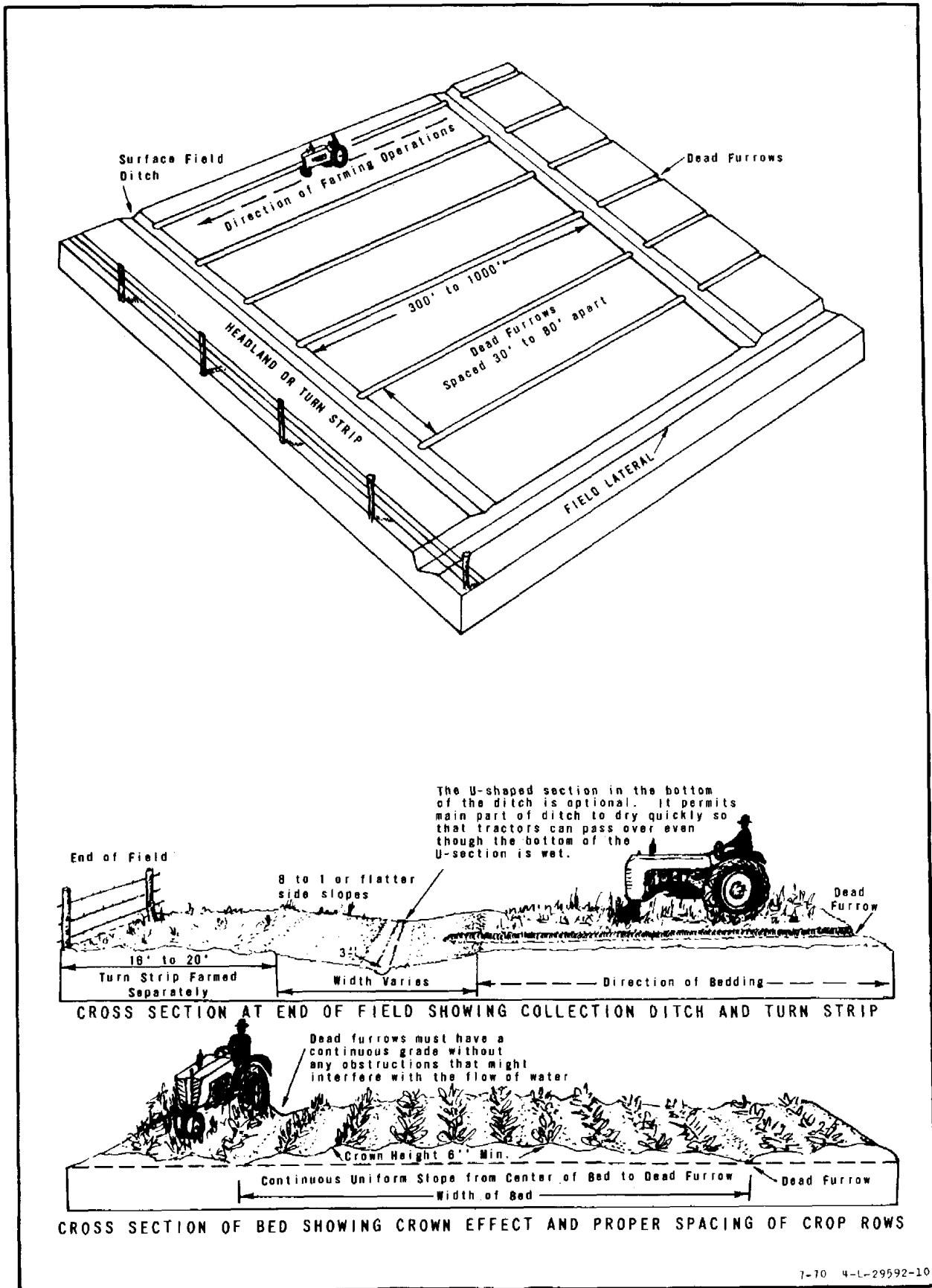

7-70 4-L-29592-10

Figure 3-11, Bedding (lands or corrugations)

graded to an outlet. Where row water discharges into deeper ditches overfall protection may be required to prevent erosion.

Land leveling

Land leveling is a precise operation of modifying the land surface to planned grades to provide more efficient irrigation. See Chapter 12, Section 15, Irrigation, SCS National Engineering Handbook.

Irrigated land also is leveled frequently to obtain drainage (3). See figures 3-12, 3-13, and 3-14 for typical irrigation drainage system layouts. In humid areas the collection ditches, or irrigation "tail water ditches," at the ends of furrows and along the borders of leveled land, must be able to receive and conduct storm runoff. This capacity must be greater than that required for handling only tail water from irrigation applications.

Classes A and B irrigation jobs, as defined in table 12-1, Chapter 12, Section 15, Irrigation, are established with uniform surface grades. In lighter soils, the length of run is governed by irrigation requirements, but in heavy soils of humid areas it is governed by drainage requirements. Land which has been leveled to irrigation specifications will meet the requirements of land grading for drainage.

For details of surveys and staking requirements for land leveling, refer to Chapter 12, Section 15, Irrigation, SCS National Engineering Handbook.

Joint Surface and Subsurface Drainage Systems

Subsurface drainage systems usually remove some surface water also. However, a joint system of surface ditches and subsurface drains will benefit crops where tolerance to standing water is low and where water may be trapped above a less permeable layer in which subsurface drains are placed. In a joint system, surface ditches are installed as prescribed in this chapter. Subsurface drains are installed as prescribed in chapter 4.

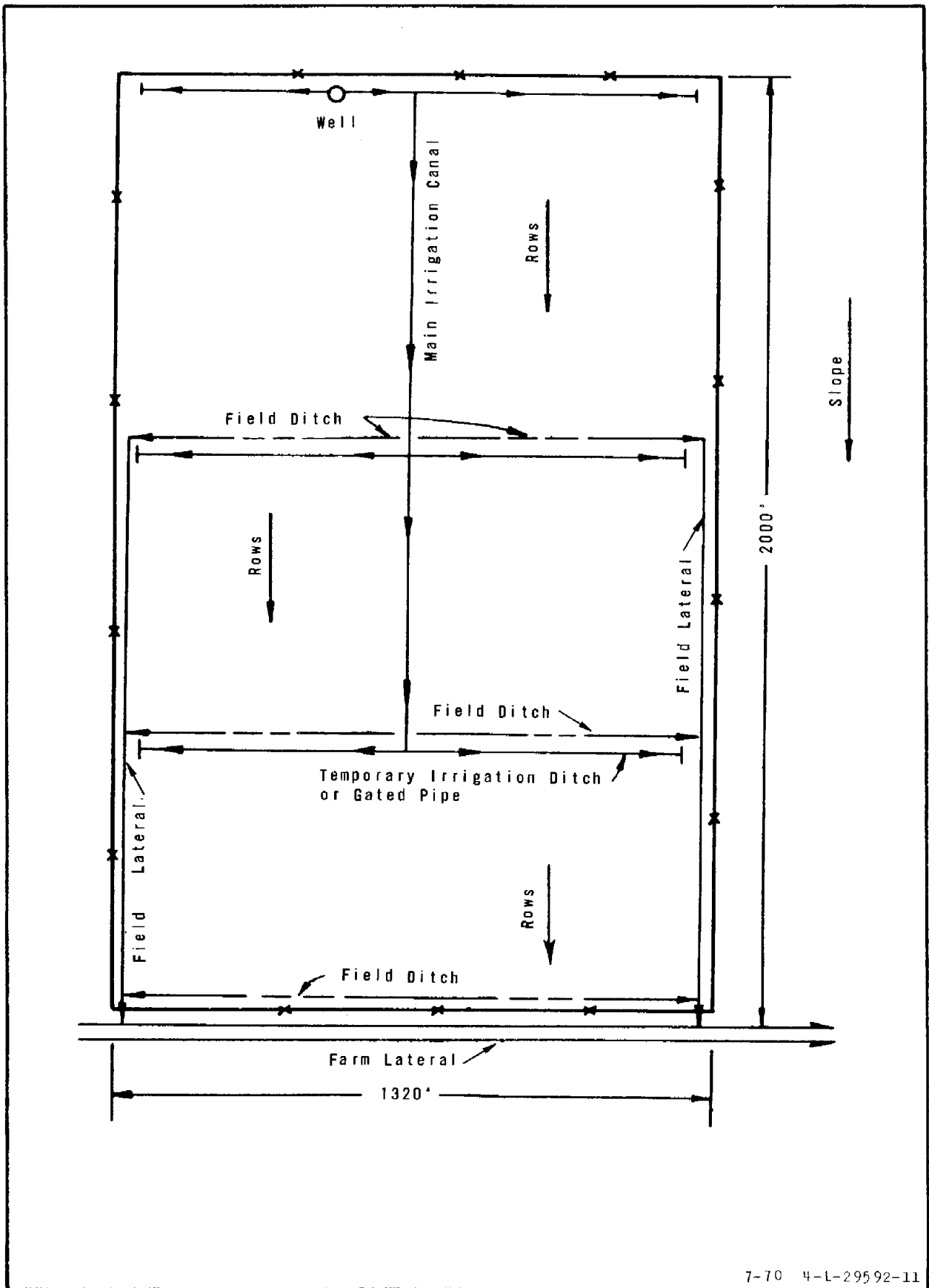

7-70 4-L-29592-11

Figure 3-12, Typical drainage system for irrigated land

(On Flat Land)

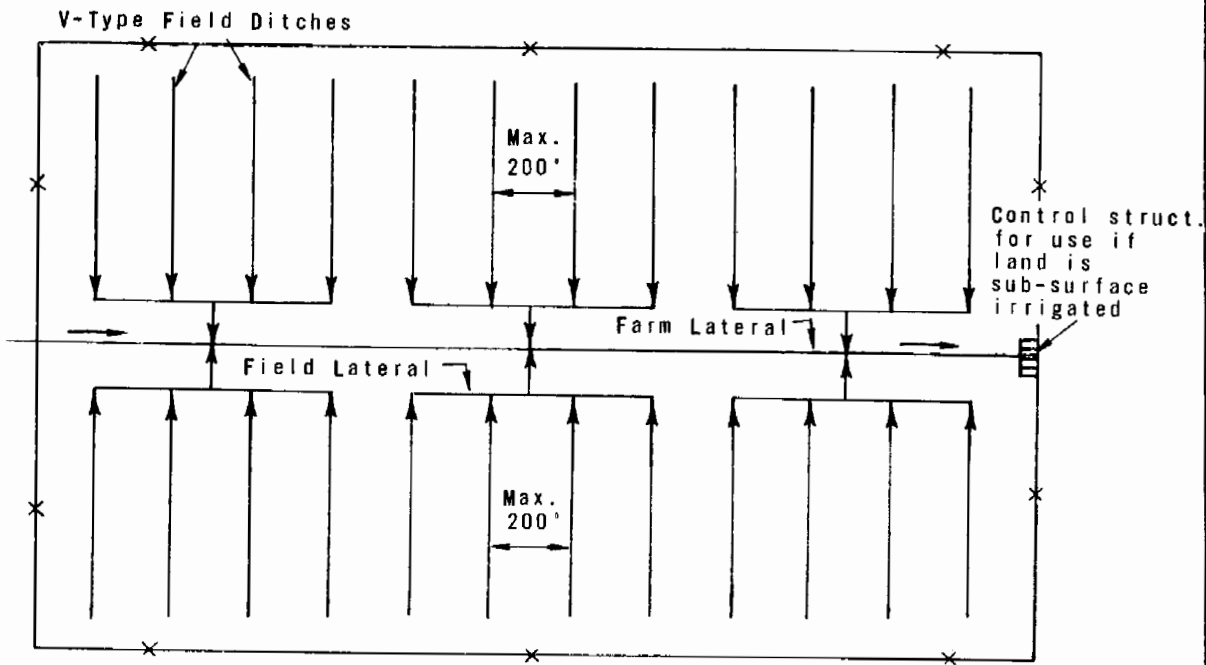

(On Slightly Sloping Land)

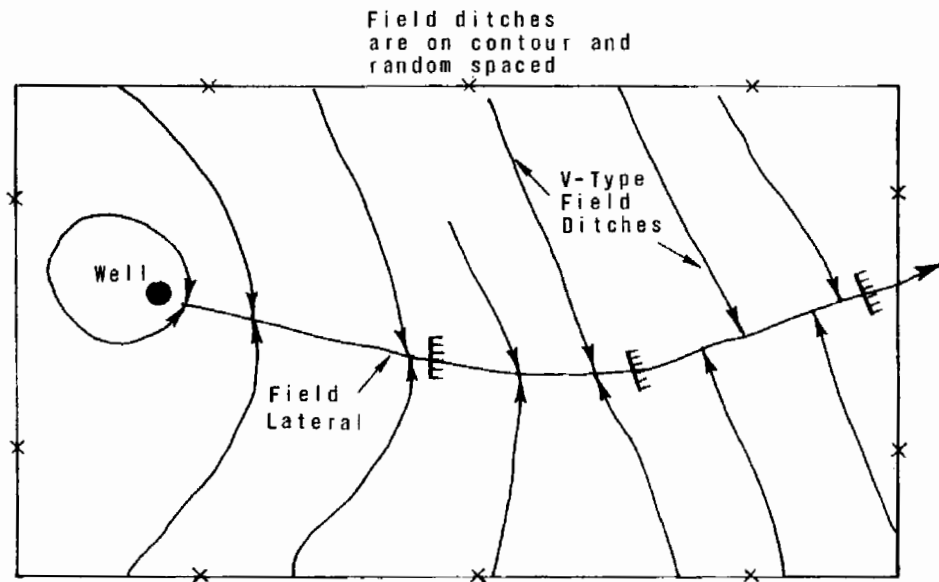

Note:
Structures (mmm) are used for gradient control and for sub-surface irrigation control

Figure 3-13, Drainage and subsurface irrigation for improved pasture

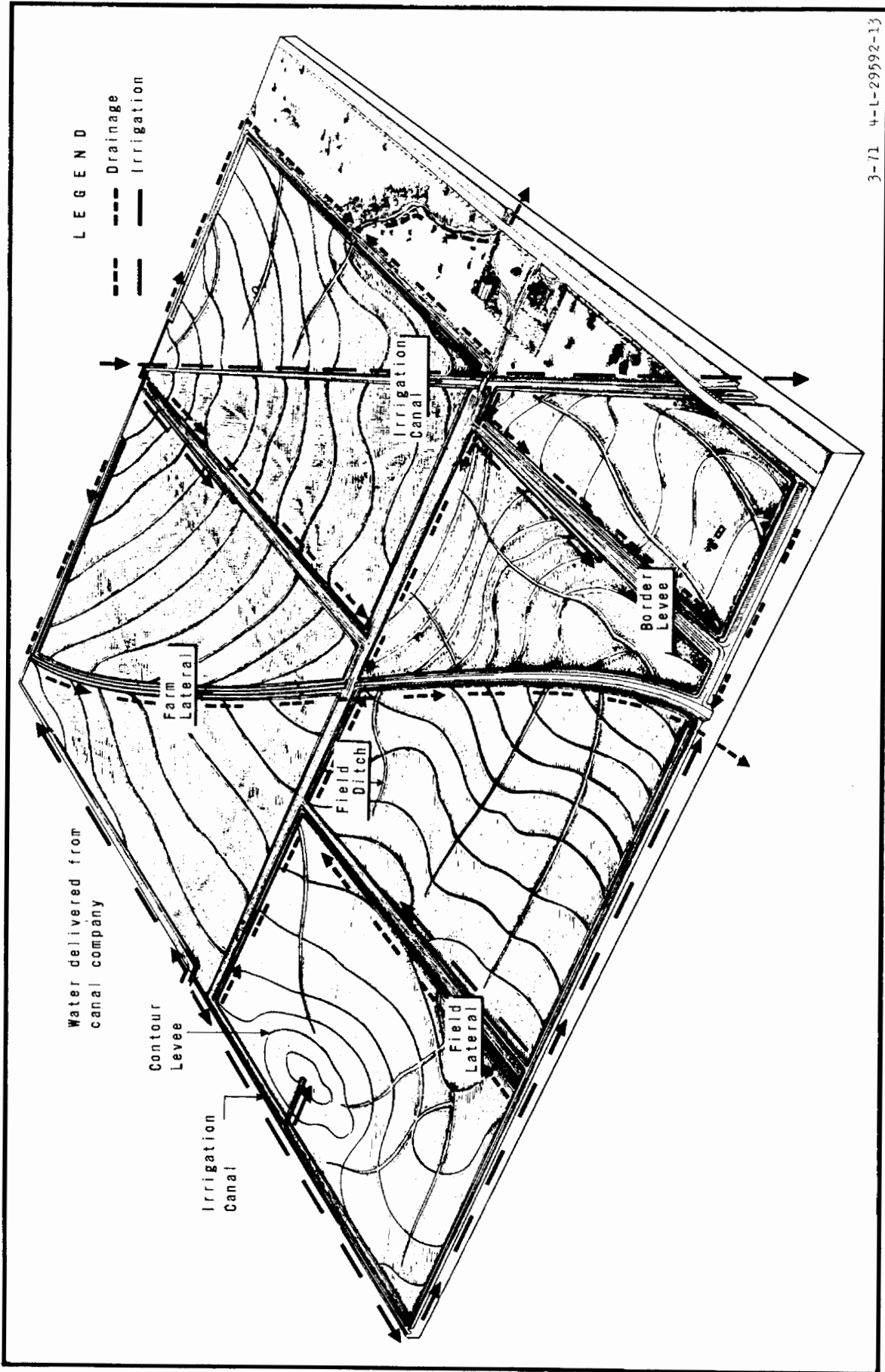

Figure 3-14, Typical layout - individual rice farm irrigation and drainage system

References

- (1) SURFACE DRAINAGE COMMITTEE - ASAE
1966. Design and Construction of Surface Drainage Systems on Farms in Humid Areas. ASAE Recommendation R-302, American Society of Agricultural Engineers, St. Joseph, Michigan 49085.
- (2) SAVESON, IRWIN L.
1963. An Efficient Drainage System for Sugar Cane. ARS 41-72, March 1963. Agricultural Research Service, USDA
- (3) LAWHON, LESTER F. and HERNDON, LOUIS W.
1965. Water Management of Ricelands in Louisiana and Texas. Journal of the Irrigation and Drainage Division, ASCE, Proceedings Paper 4569, IR4, December 1965.

NATIONAL ENGINEERING HANDBOOK

SECTION 16

DRAINAGE OF AGRICULTURAL LAND

CHAPTER 4. SUBSURFACE DRAINAGE

| <u>Contents</u> | <u>Page</u> |
|--|-------------|
| Introduction | 4-1 |
| General | 4-1 |
| Definition and purpose of subsurface drainage | 4-1 |
| Sources of excess water | 4-2 |
| Diagnosis and Improvement of Saline and Alkali Soils | 4-3 |
| General | 4-3 |
| Saline and alkali soils defined | 4-3 |
| Saline soils | 4-3 |
| Saline-alkali soils | 4-3 |
| Nonsaline-alkali soils | 4-4 |
| Effect of salts on crops | 4-5 |
| Reclamation of saline and alkali soils | 4-8 |
| Reclamation of saline soils | 4-8 |
| Reclamation of nonsaline-alkali soils | 4-8 |
| Reclamation of saline-alkali soils | 4-10 |
| Boron | 4-10 |
| Planning Subsurface Drainage | 4-11 |
| Observation well hydrographs | 4-11 |
| Profile flow patterns | 4-12 |
| Ground-water contour maps | 4-15 |
| Depth to water-table map | 4-18 |
| Classification of subsurface drainage | 4-21 |
| General | 4-21 |
| Relief drainage | 4-21 |
| Open ditches | 4-21 |
| Buried drains | 4-21 |
| Parallel system | 4-21 |
| Herringbone system | 4-22 |
| Double-main system | 4-22 |
| Random system | 4-22 |
| Pumping system (ground-water removal) | 4-22 |
| Combination system | 4-24 |
| Mole drains | 4-24 |
| Vertical drains | 4-24 |
| Interception drains | 4-25 |
| General | 4-25 |
| Open ditches | 4-25 |
| Buried drains | 4-25 |
| Outlets for subsurface drainage | 4-28 |
| Special situations | 4-28 |
| Use of relief wells | 4-28 |

| | <u>Page</u> |
|---|-------------|
| Salt-water intrusion in coastal areas | 4-31 |
| Guidelines for prevention | 4-31 |
| Planning a subsurface drainage system | 4-34 |
| Design of Subsurface Drains | 4-43 |
| Drainage coefficients | 4-43 |
| Humid areas | 4-43 |
| Arid areas | 4-44 |
| Design capacity | 4-47 |
| Relief drains | 4-47 |
| Interception drains | 4-49 |
| Combination surface and subsurface drainage systems | 4-51 |
| Depth and spacing of drains | 4-52 |
| General | 4-52 |
| Relief drains | 4-57 |
| Humid areas | 4-57 |
| Irrigated areas | 4-57 |
| Ellipse equation | 4-57 |
| Modified ellipse equation | 4-60 |
| Artesian areas | 4-69 |
| Use of open ditches for relief drainage | 4-70 |
| Interception drains | 4-70 |
| Multiple interception drains | 4-73 |
| Mole drains | 4-73 |
| Drainage area | 4-74 |
| Grade | 4-74 |
| Outlets | 4-74 |
| Length of lines | 4-77 |
| Installation Design | 4-77 |
| General | 4-77 |
| Alignment | 4-78 |
| Connections | 4-78 |
| Loads on drains | 4-78 |
| General | 4-78 |
| Underground conduits | 4-78 |
| Classification of conduits as to rigidity | 4-79 |
| Classification of conduits based on installation | 4-79 |
| Bedding conditions for rigid ditch conduits | 4-79 |
| Trench depth for rigid conduits | 4-81 |
| Bedding conditions for flexible drainage tubing | 4-81 |
| Drain grades and velocities | 4-81 |
| Determining drain size | 4-82 |
| Sizing of drains within the drainage system | 4-87 |
| Materials for drains | 4-88 |
| General | 4-88 |
| Standards and specifications | 4-88 |
| Clay drain tile | 4-89 |
| Concrete drain tile | 4-89 |
| Bituminized fiber pipe | 4-89 |
| Plastic drains | 4-90 |
| Metal pipes and others | 4-90 |

| | <u>Page</u> |
|--|-------------|
| Filters and envelopes | 4-90 |
| Determination of need for filters and envelopes | 4-90 |
| Materials for filters and envelopes | 4-92 |
| Organic filters and envelopes | 4-92 |
| Fiber-glass filters | 4-93 |
| Plastic-fabric filters | 4-93 |
| Sand and gravel filters and envelopes | 4-93 |
| Design of filters and envelopes | 4-93 |
| Design of sand and gravel filter | 4-93 |
| Design of fiber-glass filters | 4-94 |
| Design of organic filters | 4-96 |
| Design of sand and gravel envelopes | 4-96 |
| Drain appurtenances | 4-96 |
| Outlet structures | 4-96 |
| Protection from animals | 4-97 |
| Junction boxes | 4-97 |
| Pressure relief vent | 4-101 |
| Breathers | 4-101 |
| Surface water inlets | 4-102 |
| Blind inlet or french drain | 4-102 |
| Multiple drains in depressional areas | 4-104 |
| Drain crossings | 4-105 |
| Construction | 4-106 |
| General | 4-106 |
| Drain installation by hand | 4-106 |
| Batter boards | 4-106 |
| Equipment used for trenching | 4-106 |
| Excavating the trench | 4-107 |
| Laying drains | 4-107 |
| Blinding drains | 4-107 |
| Backfilling the trench | 4-107 |
| Drain installation by machine | 4-108 |
| Staking the drain | 4-108 |
| Trenching machines | 4-109 |
| Laying the tile | 4-111 |
| Installation of corrugated-plastic-drainage tubing | 4-111 |
| Drain junctions and curves | 4-112 |
| Placing filters and envelopes | 4-112 |
| Trencher placement of granular filters and envelopes | 4-113 |
| Trencher placement of fabric filters | 4-113 |
| Hand placement of granular filters | 4-114 |
| Blinding the drain | 4-114 |
| Backfilling the trench | 4-116 |
| Problems involved in drain installation | 4-116 |
| Quicksands and silts | 4-116 |
| Inspection of drain installation | 4-117 |
| General | 4-117 |
| Checking grade | 4-118 |
| Mole construction | 4-118 |
| Equipment | 4-118 |
| Mole size | 4-118 |

| | <u>Page</u> |
|--|-------------|
| Depth | 4-118 |
| Spacing | 4-118 |
| Construction | 4-118 |
| Construction procedure | 4-119 |
| Construction of open ditches for subsurface drainage | 4-119 |
| Maintenance of Buried Drains | 4-119 |
| General | 4-119 |
| Outlets | 4-119 |
| Water-surface inlets | 4-120 |
| Sand traps and catch basins | 4-120 |
| Blowouts | 4-120 |
| Tree roots | 4-120 |
| Auxiliary structures | 4-120 |
| Waterways over drains | 4-121 |
| Mineral deposits | 4-121 |
| Miscellaneous | 4-121 |
| References | 4-122 |

Figures

| | | |
|--------------|---|------|
| Figure 4-1a | Salt tolerance of field crops | 4-6 |
| Figure 4-1b | Salt tolerance of vegetable crops | 4-6 |
| Figure 4-1c | Salt tolerance of forage crops | 4-7 |
| Figure 4-2a | Soil profile showing high capillarity | 4-9 |
| Figure 4-2b | Soil profile showing low capillarity | 4-9 |
| Figure 4-3 | Observation well hydrograph | 4-13 |
| Figure 4-4 | Observation well hydrograph | 4-14 |
| Figure 4-5 | Typical ground-water contour map | 4-16 |
| Figure 4-6 | Working drawing (canal seepage) | 4-17 |
| Figure 4-7 | Surface contour above ground-water contour | 4-19 |
| Figure 4-8 | Profile section A-A, Figure 4-7 | 4-20 |
| Figure 4-9 | Types of drainage collection systems | 4-23 |
| Figure 4-10 | Interception drain in a valley area | 4-26 |
| Figure 4-11 | Interception drain for barrier condition | 4-27 |
| Figure 4-12 | Interception drain at outcrop of aquifer | 4-29 |
| Figure 4-13 | Relief well installation | 4-30 |
| Figure 4-14 | Interception drain in a constricted aquifer | 4-32 |
| Figure 4-15 | Fresh water-salt water conditions | 4-33 |
| Figure 4-16 | Working map--topography | 4-35 |
| Figure 4-17 | Working map--ground-water contours | 4-38 |
| Figure 4-18 | Working map--depth to ground water | 4-39 |
| Figure 4-19 | Working map--completed | 4-40 |
| Figure 4-20 | Profile--Figure 4-19 | 4-42 |
| Figure 4-21 | Graphical solution - drainage coefficient | 4-46 |
| Figure 4-22 | Sketch of relief drain system showing symbols in equation 4-3 | 4-48 |
| Figure 4-23 | Graphical solution - drain design discharge | 4-50 |
| Figure 4-24a | Relief ditch | 4-53 |
| Figure 4-24b | Relief drain | 4-53 |
| Figure 4-25a | Interception ditch | 4-54 |
| Figure 4-25b | Interception drain | 4-54 |

| | <u>Page</u> |
|-------------|--|
| Figure 4-26 | Isometric profiles relief and interception drains 4-56 |
| Figure 4-27 | Cross-sectional sketch showing symbols used in ellipse equation 4-58 |
| Figure 4-28 | Solution of ellipse equation (Sheet 1 of 2) 4-61 (Sheet 2 of 2) 4-62 |
| Figure 4-29 | Graphical solution of modified ellipse equation (Sheet 1 of 3) 4-64 (Sheet 2 of 3) 4-65 (Sheet 3 of 3) 4-66 |
| Figure 4-30 | Solution of modified ellipse equation 4-68 |
| Figure 4-31 | Cross-sectional profile, interception drain and area influenced 4-72 |
| Figure 4-32 | Mole drainage system on flatland 4-75 |
| Figure 4-33 | Mole drainage system on sloping land 4-75 |
| Figure 4-34 | Buried drain outlet for mole drain 4-76 |
| Figure 4-35 | Mole drain outlets 4-76 |
| Figure 4-36 | Capacity chart - $n = 0.011$ (Sheet 1 of 3) 4-84 $n = 0.013$ (Sheet 2 of 3) 4-85 $n = 0.015$ (Sheet 3 of 3) 4-86 |
| Figure 4-37 | Mechanical analyses of gravel filter material 4-95 |
| Figure 4-38 | Filter installation 4-96 |
| Figure 4-39 | Outlet protection 4-97 |
| Figure 4-40 | Drain outlets 4-98 |
| Figure 4-41 | Rodent protection for outlet pipe 4-99 |
| Figure 4-42 | Junction box for drains 4-100 |
| Figure 4-43 | Vent 4-101 |
| Figure 4-44 | Surface water inlet 4-102 |
| Figure 4-45 | Manhole catch basin or sediment trap 4-103 |
| Figure 4-46 | Blind inlet 4-104 |
| Figure 4-47 | Closely spaced drains in wet areas 4-104 |
| Figure 4-48 | Drain crossings 4-105 |

Tables

| | |
|-----------|---|
| Table 4-1 | Relative salt tolerance of fruit crops 4-7 |
| Table 4-2 | Boron tolerance of crops 4-11 |
| Table 4-3 | Observation well data 4-36 |
| Table 4-4 | Drainage coefficients without surface-water inlets 4-43 |
| Table 4-5 | Maximum allowable trench depth 4-80 |
| Table 4-6 | Drain grades and velocities 4-83 |
| Table 4-7 | Classification to determine need for drain filters, or envelopes, and minimum velocities in drains 4-91 |

NATIONAL ENGINEERING HANDBOOK

SECTION 16

DRAINAGE OF AGRICULTURAL LAND

CHAPTER 4. SUBSURFACE DRAINAGE

Introduction

This chapter covers subsurface drainage in both humid and arid areas of the United States. The division between the subhumid and the semiarid areas is approximately the 100th meridian. The boundary separating the subhumid from the dry lands receives close to 18 inches of precipitation in the north and about 25 inches in Texas (1). The coastal areas of the Pacific Northwest, the Gulf Coast, and small scattered areas within the intermountain region are humid areas with average rainfall over 20 inches. Irrigated areas in the United States are largely in the arid and semiarid portions of the country.

Chapter 2, Drainage Investigations, of this National Engineering Handbook discusses investigations and surveys commonly used in agricultural drainage operations. Reference will be made to Chapter 2 for information in regard to general methods and techniques for conducting these investigations. This chapter supplements the information in Chapter 2 with more detailed information on certain phases of drainage investigations. Subsurface-drainage conditions, drainage benefits, planning, design, materials, installation, and maintenance will be discussed in this chapter.

In most humid areas, many years of experience with subsurface drainage installation have provided the main basis for determining drainage requirements for various soil types and problem areas. Special investigations are necessary for drainage of soils where experience is lacking.

There are some differences in the cause, effect, and solutions of drainage problems in the arid and semiarid regions, but in general the investigational methods, design, construction, and maintenance are similar. In areas where there have been many years of drainage experience, investigations may be standardized and routine. Where experience has been limited or special problems exist, more extensive investigations are necessary. High water tables, seepage, soil salinity and/or alkalinity are problems that usually require special investigation and consideration.

General

Definition and purpose of subsurface drainage

Subsurface drainage is defined as the removal of excess ground water below the ground surface. In many wet areas both surface and subsurface drainage are required. Surface ditches are necessary to remove excess runoff from precipitation and to dispose of surface flow from irrigation. These surface ditches should be planned to complement the subsurface drainage system. Surface drainage reduces the amount of water to be removed by the subsurface system and permits better control of the water table. Subsurface drainage lowers the high water tables which are caused by precipitation, irrigation water, leaching water, seepage from higher lands or irrigation canals and ditches and ground water under artesian pressure.

A high water table damages most crops to varying degrees. Soil bacterial action is retarded when pore spaces are filled with water because the bacteria must have access to oxygen from the air. Properly drained soils will warm up more quickly in the spring than saturated soils. Good drainage permits earlier planting and better germination. Where drainage lowers a high water table, this increases the active root-zone depth and allows plants to develop their natural root pattern. Where excessive soluble salts are present in the soil profile, good subsurface drainage re-establishes downward percolation of water in the soil profile and permits leaching of these salts.

The optimum depth of the water table is not a constant for all areas, but varies with soil texture, depth of soil and subsoil layers, crops grown, and salinity. In fine-textured soils and subsoils the height of the capillary fringe above the water table may be a controlling factor. This is especially true where harmful soluble salts are present and are pumped to the soil surface through capillarity. In coarse-textured soils or soils underlain by coarse-textured sands or gravels, capillarity may be slight, and the capillary fringe may extend very little above the water table. Under usual conditions where salts are present, a water table within less than 6 feet from the ground surface may be damaging to plant growth. In studying the critical depth of the water table, the position of the capillary fringe must always be considered.

For a permanent irrigation agriculture, salt must be removed from the soil at the same rate as it is introduced by the irrigation water, otherwise a steadily increasing salt concentration in the soil water will cause progressive reductions in crop yield. When salt removed equals salt input, a project is said to be in "salt balance." Salt balance in irrigated areas is maintained by applying excess water in addition to crop needs to leach soluble salts. Subsurface drainage must be adequate to permit the necessary leaching and to hold the water table to a sufficient depth to prevent the upward movement of salty capillary water from reaching the crop root zone.

Sources of excess water

In humid areas the major portion of excess water comes from precipitation which percolates into the soil to become ground water. Where there is poor surface drainage on flat land, temporary flooding occurs and a large percentage of the rainfall infiltrates into the soil.

In northern areas, snow cover frequently protects the soil from freezing, and infiltration of water into the soil is increased. The rate of snow melt and condition of the soil influences the amount of water absorbed by the soil.

In arid and semiarid areas a minor portion of excess water comes from precipitation. The major sources of excess water in irrigated areas are percolation losses from the irrigation and leaching water applied. Losses occur from irrigation canals or ditches within or traversing the area.

In humid, arid, and semiarid areas the source of excess water may be ground water moving through shallow aquifers and emerging as seeps or springs, or ground water under artesian pressure.

When the total quantity of water introduced into the soil from the various sources exceeds the total quantity disposed of through natural drainage processes, the water table will rise. It is then necessary to install artificial drains to remove the surplus water to maintain the water table at some predetermined level which is not damaging to the crops.

Diagnosis and Improvement of Saline and Alkali Soils

General

The diagnosis and improvement of saline and alkali soils involves problems in soil chemistry. These problems are frequently associated with areas needing drainage, especially in arid and semiarid regions, and it is necessary for the drainage engineer to become familiar with them. A publication of the United States Salinity Laboratory, "Diagnosis and Improvement of Saline and Alkali Soils," USDA Agricultural Handbook 60 (2), contains an excellent discussion of the subject including practical methods of treatment. Subsequent publications of the U. S. Salinity Laboratory staff supplement the information contained in Agricultural Handbook 60.

Saline and alkali soils defined

To facilitate a discussion of saline and alkali soils, they have been separated into three groups: saline, saline-alkali, and nonsaline-alkali soils. These three groups are defined in Agricultural Handbook 60 as follows:

"Saline soils. - Saline is used in connection with soils for which the conductivity of the saturation extract is more than 4 mmhos/cm. at 25° C. and the exchangeable-sodium-percentage is less than 15. Ordinarily, the pH is less than 8.5. These soils correspond to Hilgard's (1906) "white alkali" soils and to the "Solonchaks" of the Russian soil scientists. When adequate drainage is established, the excessive soluble salts may be removed by leaching and they again become normal soils.

"Saline soils are often recognized by the presence of white crusts of salts on the surface. Soil salinity may occur in soils having distinctly developed profile characteristics or in undifferentiated soil material such as alluvium.

"The chemical characteristics of soils classed as saline are mainly determined by the kinds and amounts of salts present. The amount of soluble salts present controls the osmotic pressure of the soil solution. Sodium seldom comprises more than half of the soluble cations and hence is not adsorbed to any significant extent. The relative amounts of calcium and magnesium present in the soil solution and on the exchange complex may vary considerably. Soluble and exchangeable potassium are ordinarily minor constituents, but occasionally they may be major constituents. The chief anions are chloride, sulfate, and sometimes nitrate. Small amounts of bicarbonate may occur, but soluble carbonates are almost invariably absent. In addition to the readily soluble salts, saline soils may contain salts of low solubility, such as calcium sulfate (gypsum) and calcium and magnesium carbonates (lime).

"Owing to the presence of excess salts and the absence of significant amounts of exchangeable sodium, saline soils generally are flocculated; and, as a consequence, the permeability is equal to or higher than that of similar nonsaline soils.

"Saline-alkali soils. - Saline-alkali is applied to soils for which the conductivity of the saturation extract is greater than 4 mmhos/cm. at 25° C. and the exchangeable-sodium-percentage is greater than 15. These soils form as a result of the combined processes of salinization and alkalization. As long as excess salts are present, the appearance and

properties of these soils are generally similar to those of saline soils. Under conditions of excess salts, the pH readings are seldom higher than 8.5 and the particles remain flocculated. If the excess soluble salts are leached downward, the properties of these soils may change markedly and become similar to those of nonsaline-alkali soils. As the concentration of the salts in the soil solution is lowered, some of the exchangeable sodium hydrolyzes and forms sodium hydroxide. This may change to sodium carbonate upon reaction with carbon dioxide absorbed from the atmosphere. In any event, upon leaching, the soil may become strongly alkaline (pH readings above 8.5), the particles disperse, and the soil becomes unfavorable for the entry and movement of water and for tillage. Although the return of the soluble salts may lower the pH reading and restore the particles to a flocculated condition, the management of saline-alkali soils continues to be a problem until the excess salts and exchangeable sodium are removed from the root zone and a favorable physical condition of the soil is reestablished.

"Saline-alkali soils sometimes contain gypsum. When such soils are leached, calcium dissolves and the replacement of exchangeable sodium by calcium takes place concurrently with the removal of excess salts.

"Nonsaline-alkali soils. - Nonsaline-alkali is applied to soils for which the exchangeable-sodium-percentage is greater than 15 and the conductivity of the saturation extract is less than 4 mmhos/cm. at 25° C. The pH readings usually range between 8.5 and 10. These soils correspond to Hilgard's "black alkali" soils and in some cases to "Solonetz", as the latter term is used by the Russians. They frequently occur in semiarid and arid regions in small irregular areas, which are often referred to as "slick spots." Except when gypsum is present in the soil or the irrigation water, the drainage and leaching of saline-alkali soils leads to the formation of nonsaline-alkali soils. As mentioned in the discussion of saline-alkali soils, the removal of excess salts in such soils tends to increase the rate of hydrolysis of the exchangeable sodium and often causes a rise of the pH reading of the soil. Dispersed and dissolved organic matter present in the soil solution of highly alkaline soils may be deposited on the soil surface by evaporation, thus causing darkening and giving rise to the term "black alkali".

"If allowed sufficient time, nonsaline-alkali soils develop characteristic morphological features. Because partially sodium-saturated clay is highly dispersed, it may be transported downward through the soil and accumulate at lower levels. As a result, a few inches of the surface soil may be relatively coarse in texture and friable; but below, where the clay accumulates, the soil may develop a dense layer of low permeability that may have a columnar or prismatic structure. Commonly, however, alkali conditions develop in such soils as a result of irrigation. In such cases, sufficient time usually has not elapsed for the development of the typical columnar structure, but the soil has low permeability and is difficult to till.

"The exchangeable sodium present in nonsaline-alkali soil may have a marked influence on the physical and chemical properties. As the proportion of exchangeable sodium increases, the soil tends to become more dispersed. The pH reading may increase, sometimes becoming as high as 10. The soil solution of nonsaline-alkali soils, although relatively low in soluble salts, has a composition that differs considerably from that of normal and saline soils. While the anions present consist mostly of

chloride, sulfate, and bicarbonate, small amounts of carbonate often occur. At high pH readings and in the presence of carbonate ions, calcium and magnesium are precipitated; hence, the soil solutions of nonsaline-alkali soils usually contain only small amounts of these cations, sodium being the predominant one. Large quantities of exchangeable and soluble potassium may occur in some of these soils. The effect of excessive exchangeable potassium on soil properties has not been sufficiently studied.

"Nonsaline-alkali soils in some areas of western United States have exchangeable-sodium-percentages considerably above 15, and yet the pH reading, especially in the surface soil, may be as low as 6. These soils have been referred to by De Sigmond (1938) as degraded alkali soils. They occur only in the absence of lime, and the low pH reading is the result of exchangeable hydrogen. The physical properties, however, are dominated by the exchangeable sodium and are typically those of a nonsaline-alkali soil."

Effect of salts on crops

To understand the effect of salt concentration on vegetation requires an understanding of the process of osmosis. This is the process whereby plants obtain their moisture from the soil. If two solutions of different strength are separated by a semipermeable membrane, the weaker solution will move through the membrane to the stronger solution. This movement will be in proportion to the difference in pressure between the two solutions which is in direct proportion to the difference in the number of solvent particles. This difference in pressure is termed the "osmotic pressure" and flow through the membrane continues until equilibrium between the two pressures is established. Plant roots have a semipermeable membrane or "skin" that separates the fluid within the plant roots from the soil moisture. Under normal soil conditions (nonsaline) the solution or fluid within the plant roots is a stronger solution than the soil moisture, and a pressure differential (osmotic pressure) is always present. The net difference in pressure is affected also by the soil-moisture tension. When this exists, the plant roots receive an inflow of water or soil moisture sufficient for growth. When soils become salty or saline, the concentration of salt in the soil moisture increases and approaches the concentration in the plant fluid, thereby reducing the inflow of water to the plants. If the soil-moisture solution becomes too strong, osmosis slows down to the point where the plant will wilt. This explains the condition where plants are wilting even though virtually submerged in water.

From the foregoing it is obvious that salinity control is vital to agriculture. It is usually associated with irrigation in western areas, and the irrigation engineer must recognize this and make adequate provisions for maintaining salt balance in the design and operation of irrigation projects. The drainage engineer must understand the principles involved in the drainage of irrigated land in the arid or semiarid areas. There are some cases where it is not economically feasible to reclaim saline or alkali lands by providing adequate subsurface drainage, leaching water, and chemical amendments as required. In these situations the best use of the land may be to plant crops with high salt tolerance, or if the salt condition is severe, to adapted forage crops. Figures 4-1a, 1b, and 1c, Salt tolerance of field, vegetable, and forage crops (3), and Table 4-1, Relative salt tolerance of fruit crops (4), are included as guides to selecting crops suitable to these situations. In Figures 4-1a, 1b, and 1c the indicated salt tolerances apply to the period of rapid plant growth and maturation, from the late seedling stage onward. Crops in each category are ranked in order of decreasing salt tolerance. Width of the bar next to each crop indicates the effect of increasing salinity on yield.

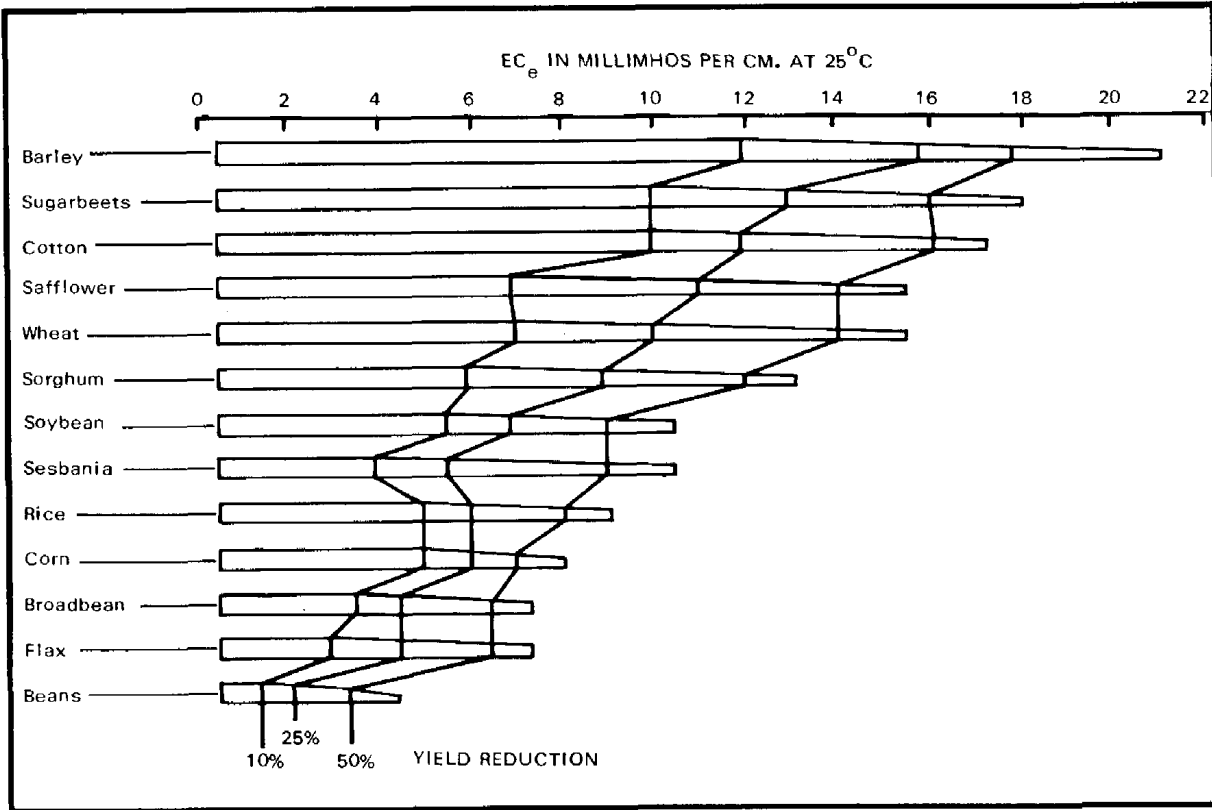

Figure 4-1a, Salt tolerance of field crops

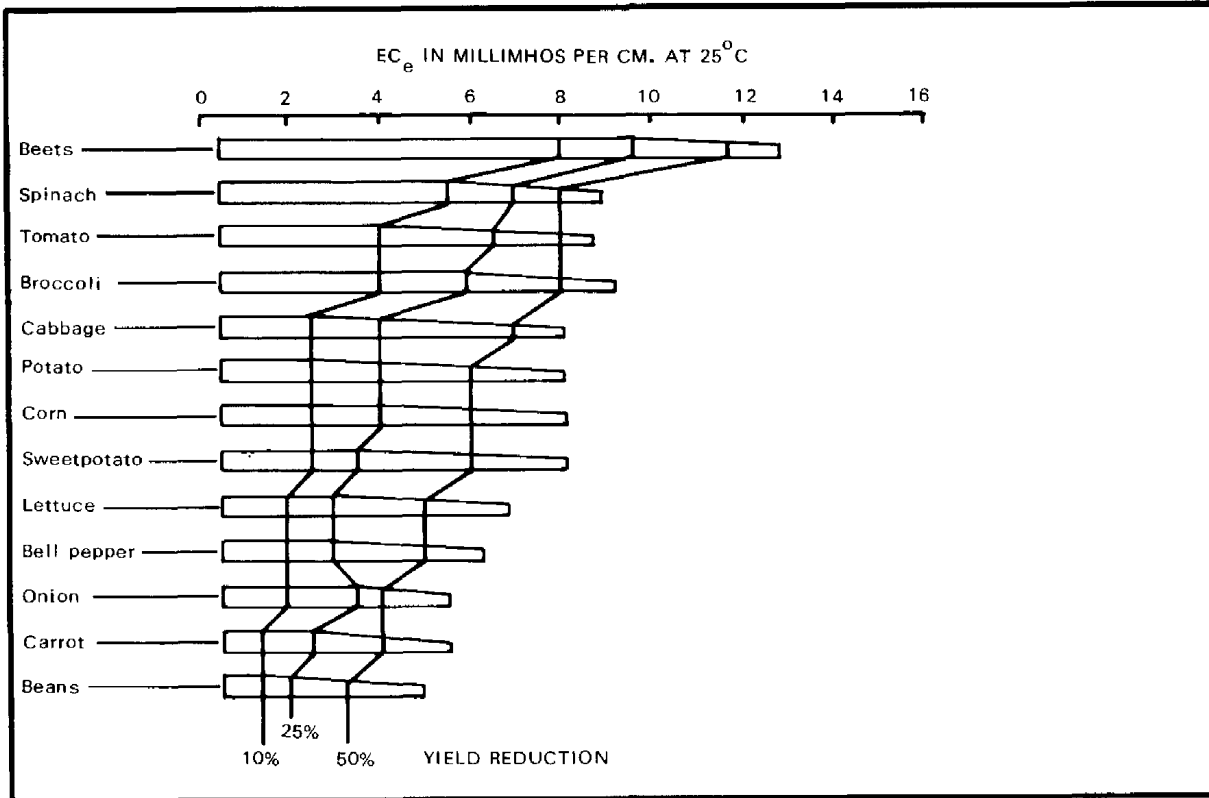

Figure 4-1b, Salt tolerance of vegetable crops

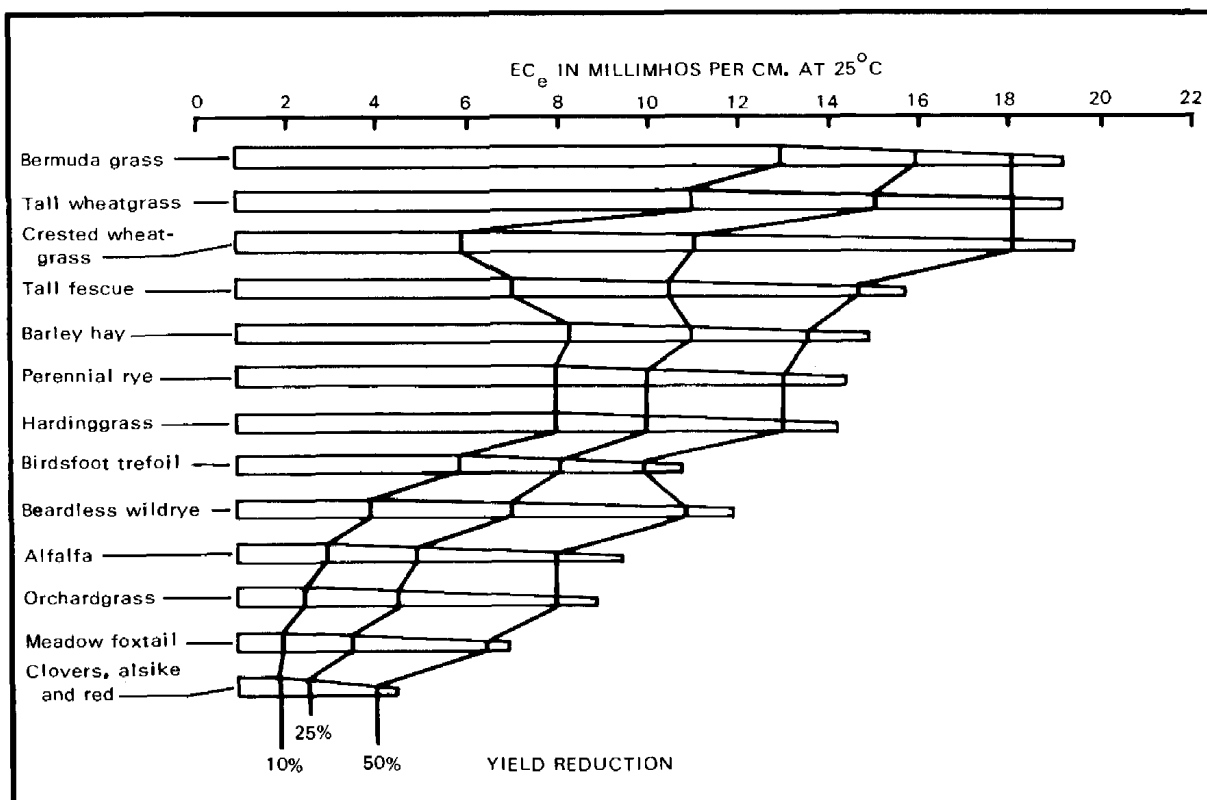

Figure 4-1c, Salt Tolerance of forage crops

Table 4-1, Relative salt tolerance of fruit crops

| Crop | Electrical conductivity of saturation extracts (EC _e) at which yields decrease by about 10 percent ¹ | |
|---|---|---|
| | Millimhos per centimeter at 25°C. | |
| Date palm _____ | 8 | } ¹ In gypsiferous soils, EC readings for given soil salinities are about 2 millimhos per centimeter higher than for nongypsiferous soils. Date palm would be affected at 10 millimhos per centimeter, grapes at 6 millimhos per centimeter, etc., on gypsiferous soils. |
| Pomegranate _____ | 2-6 | |
| Fig _____ | | |
| Olive _____ | | |
| Grape _____ | 4 | ² Estimate. |
| Muskmelon _____ | 3.5 | ³ Lemon is more sensitive than orange and grapefruit; raspberry is more sensitive than boysenberry and blackberry. |
| Orange, grapefruit, lemon ³ _____ | 3-2.5 | |
| Apple, pear _____ | 2.5 | |
| Plum, prune, peach, apricot, almond _____ | 2.5 | |
| Boysenberry, blackberry, raspberry ³ _____ | 2.5-1.5 | |
| Avocado _____ | 2 | |
| Strawberry _____ | 1.5 | |

Crosslines are placed at 10-, 25-, and 50-percent yield reductions. The relative growth and production of the various crops on saline and alkali soils will give an indication of the soil salinity.

Reclamation of saline and alkali soils

In most of the humid areas of the United States salinity is not a problem, as natural precipitation has leached most of the soluble salts from the soil. In the arid and semiarid regions, where precipitation is low, salinity and alkalinity are common problems. Saline soils, soils with a high percentage of soluble salt, can be reclaimed by leaching and drainage. Alkali soils, soils with a relatively high percentage of sodium salt, are not readily reclaimed by leaching and may require additional treatment with selected chemical amendments in connection with the leaching. Saline-alkali soils are a composite group having a high percentage of both soluble and insoluble salts and the reclamation of these soils may require chemical treatment or leaching with salty water prior to the usual leaching and drainage treatment.

Most of the irrigated areas in the arid and semiarid region have some soils that are saline, alkali, or both. This condition is common in the low-rainfall regions where the average annual precipitation is less than 20 inches. The drainage of saline and alkali soils generally requires drains that are deeper than are needed in areas of neutral or acid soils. The reason for this is that in saline and alkali areas harmful salts move upward by capillarity into the root zone, thereby limiting its useful depth. The required depth for drains in salty areas is to some degree related to the capillary rise in the particular soils and subsoils in the area. Assuming a free water-table level at the same depth, drains in soils with a high capillary rise will need to be deeper than in soils with a low capillary rise. This is illustrated in Figures 4-2a and 4-2b. As a general rule, subsurface drains in saline and alkali areas should range in depth from 6 to 10 feet.

Saline conditions are identified on some soil maps and these should be noted during the reconnaissance investigation. Alkalinity is not usually mapped as a part of regular soil surveys, unless by special request, as this requires special field or laboratory analyses. If during the reconnaissance, alkaline conditions are suspected, it is advisable to consult a soil scientist before proceeding further with extensive surveys and investigations. This is important at this stage of planning as the treatment of alkali soils, in addition to establishing subsurface drains, may increase the cost of the project to the extent that it may not be feasible.

Reclamation of saline soils

Saline soils can usually be improved through leaching, as the soluble salts present will go into solution and be removed with the drain water. Leaching in areas of high precipitation is a natural process after subsurface drainage is established. In arid and semiarid regions it is usually necessary to supply irrigation water to accomplish this leaching. Thus, the reclamation of saline soils can usually be accomplished through some type of leaching without the addition of chemical amendments. Adequate subsurface drainage is a prerequisite.

Reclamation of nonsaline-alkali soils

The treatment of nonsaline-alkali soils is different from that for saline soils as it may be impossible to leach the soil until after certain chemical amendments are added. Through alkalization soil undergoes certain textural changes. These changes tend to destroy the original soil texture and leave the soil as a deflocculated mass. Alkali soils have the consistency of tar or heavy grease,

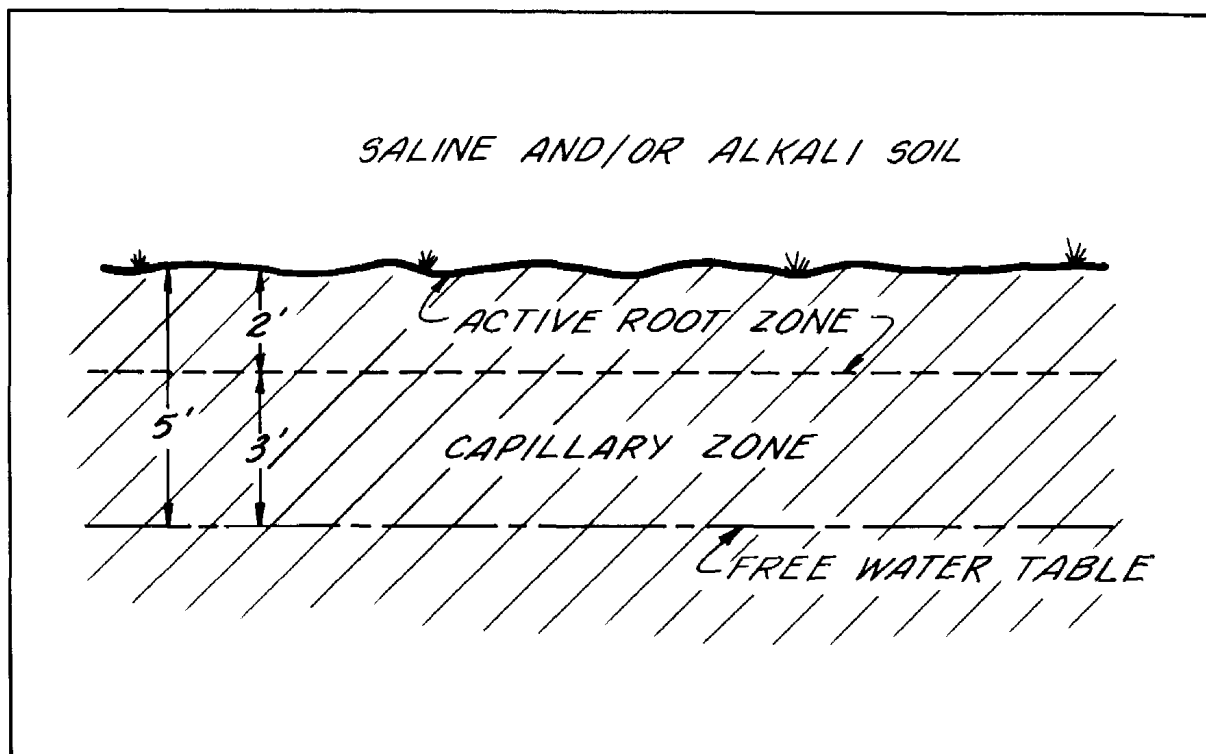

Figure 4-2a, Soil profile showing high capillarity

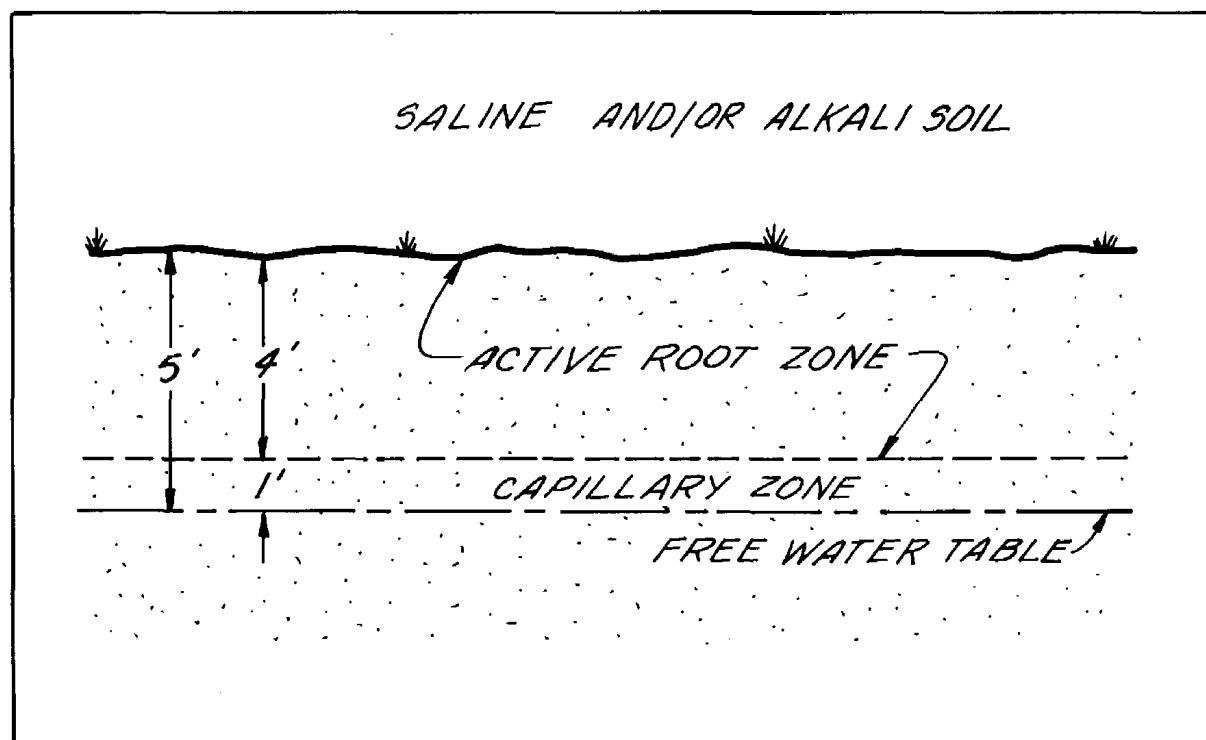

Figure 4-2b, Soil profile showing low capillarity

which is smooth and without texture. Spots of alkali soil in fields are often and appropriately referred to as "slick spots" meaning that they are void of vegetation and textureless. As alkalization progresses, the soil becomes less and less permeable. Strongly alkaline soils become virtually impermeable and impracticable to drain under most conditions.

It is highly important that nonsaline-alkali soils be recognized as such before attempting to establish subsurface drainage. These soils have lost some of their internal drainage characteristics and may not drain properly regardless of the type of drainage system installed. Where it is economically feasible to reclaim these soils, chemical treatment may be necessary to flocculate the soil particles and restore soil permeability before leaching and drainage. Some of the chemical amendments commonly used are calcium chloride, gypsum (calcium sulfate), sulphur, and sulphuric acid. The kind and amount of amendment applied must be based on recommendations from a laboratory following an analysis of representative soil samples.

Reclamation of saline-alkali soils

The treatment of saline-alkali soils is much the same as for nonsaline-alkali soils. Certain chemical amendments may be required, based on laboratory analyses of soil samples. Field identification of saline-alkali soils is difficult as they may exhibit characteristics of both saline and nonsaline-alkali soils. As pointed out in the definition of saline-alkali soils, they may be flocculated due to the presence of excess salts and may have a permeability equal to or higher than nonsaline soils. This is often misleading and may give the impression that soils can be reclaimed through simple leaching. Actually this may not be the case because leaching will remove the soluble salts, thereby causing the soils to become strongly alkaline and the permeability greatly reduced.

Boron

Boron toxicity is a problem in parts of the arid and semiarid regions of southwestern United States. Boron has been found to be present in scattered areas of desert soils that have been reclaimed for irrigation. It is usually associated with saline and alkali soils; however, this is probably accidental as most soils in this general area are salty soils. Boron is essential to the normal growth of all plants but the concentration required is very small, less than 1.0 ppm, and if exceeded may cause plant injury. Certain plant species vary both in boron requirement and in boron tolerance. The concentrations necessary for the growth of plants having a high boron requirement may also be toxic to plants sensitive to boron. This makes it very difficult, if not impossible, to generalize on boron limitations for certain areas without considering the crops and their respective tolerance to boron.

In areas where excess boron occurs, in the soil or in the irrigation water used, boron-tolerant crops should be grown. Table 4-2 indicates the relative boron tolerance of a number of crops grown in areas known to have excess boron.

Symptoms of boron injury may include characteristic chlorosis and necrosis although some boron-sensitive species do not show visible symptoms. Citrus, avocados, persimmons, and many other species develop a tipburn or marginal burn of mature leaves. Boron injury to walnut leaves is characterized by marginal burn and brown-necrotic areas between the veins. Stone-fruit trees, apples, and pears are sensitive to boron, but do not develop typical leaf symptoms. Cotton, grapes, potatoes, beans, peas, and several other plants show marginal burning and a cupping of the leaf that results from a restriction of the growth of the marginal area.

Table 4-2, Boron tolerance of crops (2).

| Sensitive | Semitolerant | Tolerant |
|------------|--------------|-------------|
| Pecan | Potato | Asparagus |
| Walnut | Cotton | Date Palm |
| Artichoke | Tomato | Sugar Beet |
| Navy Bean | Radish | Garden Beet |
| Plum | Peas | Alfalfa |
| Pear | Olive | Broadbean |
| Apple | Barley | Onion |
| Grape | Wheat | Turnip |
| Fig | Corn | Cabbage |
| Persimmon | Milo | Lettuce |
| Cherry | Oat | Carrot |
| Peach | Pumpkin | |
| Apricot | Pepper | |
| Blackberry | Sweet Potato | |
| Orange | Lima Bean | |
| Avocado | | |
| Grapefruit | | |
| Lemon | | |

Current information on boron tolerance does not permit the establishment of definite permissible limits for the three classifications shown in this table. It is thought that the approximate range from sensitive to tolerant is 0.7 ppm to 2.0 ppm of boron.

High levels of boron in soils can usually be reduced through leaching; however, this varies with soil types. Leaching of boron is a slow process and usually requires three to four times as much leaching water as is required for saline and alkali soils. The most economical treatment of boron-affected soils may be to switch to boron-tolerant crops and to apply excess irrigation water (leaching requirement) for a period of several years. This will not deprive the operator of crop income during the leaching process. Good subsurface drainage is always a prerequisite for proper leaching.

Planning Subsurface Drainage

One of the most important phases of planning subsurface drainage is to compile and analyze the field data collected through various surveys, investigations, and studies. Investigations for subsurface drainage are difficult because subsoil and ground-water conditions are not evident through visual inspection of wet areas. Various methods and techniques have been developed whereby these conditions can be determined and made evident through a graphical or statistical presentation. The following is a discussion of some of the methods and procedures commonly used.

Observation well hydrographs

Water-table elevation should be plotted against time on profile paper, cross-section paper, or preferably, printed hydrograph sheets. The time scale which is usually on the abscissa (horizontal) is graduated in days, by months, for a 1-year period. The elevation scale is usually on the ordinate (vertical) and is graduated in feet and tenths to cover the anticipated fluctuation range of the water table. Observation well hydrographs are used where a series of water-table readings are taken at a single-well location for at least a 1-year period or over a cropping or seasonal weather cycle. By plotting these

on a hydrograph sheet it is possible, at a glance, to visualize the water-table behavior at that well. Figure 4-3 illustrates a hydrograph showing two plots; one for a well in an irrigated area and one for a well in a non-irrigated or dryland area.

Observation well hydrographs are often helpful in determining the source of ground water. In the humid area the ground water is usually highest in the late spring at the base of slopes joining uplands and in narrow valleys where deep seeps and artesian water are often present. In irrigated areas ground-water levels tend to build up through the irrigation season reaching a peak at the end of the irrigation period. The illustration shown is for a single-crop area where the highest ground water usually occurs in September or October. In areas where multiple cropping is practiced this will vary with the periods of irrigation. In nonirrigated or dryland areas where accretions to ground water are from precipitation, ground-water levels tend to peak in the spring or early summer months, or after the rainy season. From this it is obvious that well hydrographs may indicate the source of water causing the high water-table condition, i.e., from precipitation or irrigation water.

Figure 4-4 is a hydrograph for a specific observation well in an irrigated area, which also shows a log of the subsurface materials. This type of hydrograph is often very helpful in relating fluctuations of the water table to specific underground strata. It is also an aid to determining the proper drain depth to take advantage of the most permeable strata. This combination hydrograph-log-type representation is preferred by some engineers.

Profile flow patterns

Profile flow patterns may be shown by plotting the surface of the ground, information on subsoil materials, and hydraulic-head values at points where measurements have been made with piezometers. Lines should be drawn to connect points of equal hydraulic head. Convenient hydraulic-head intervals may be selected extending over the range of measured values for hydraulic head. Usually an interval is selected that allows a number of equal hydraulic-head lines to be sketched on the same profile. The component of flow in the plane of the profile is normal to lines of equal hydraulic head if the profile section is plotted on a one to one scale. Using this scale, flow lines can be sketched in at right angles to the equal hydraulic-head lines, with arrows to show the direction of flow. If the vertical scale is exaggerated, the relation between stream lines and equal hydraulic-head lines on the plotted profile is no longer rectangular. Where the vertical and horizontal scales are not equal, the hydraulic-head distribution may be plotted, but flow lines should not be drawn.

A vertical component of flow is indicated where the hydraulic head changes. This component may be either up or down. An equal hydraulic-head line may intercept the water table at any angle, depending on the direction of flow. The water table is not necessarily a flow line as is often assumed, although it may be. A component of upward flow that exists below the water table may continue upward through the soil above the water table to the soil surface by capillarity. Likewise, downward flow may occur in the unsaturated soil above the water table. This is discussed in more detail in Chapter 1, and is illustrated by Figures 1-1 and 1-2 in Chapter 1.

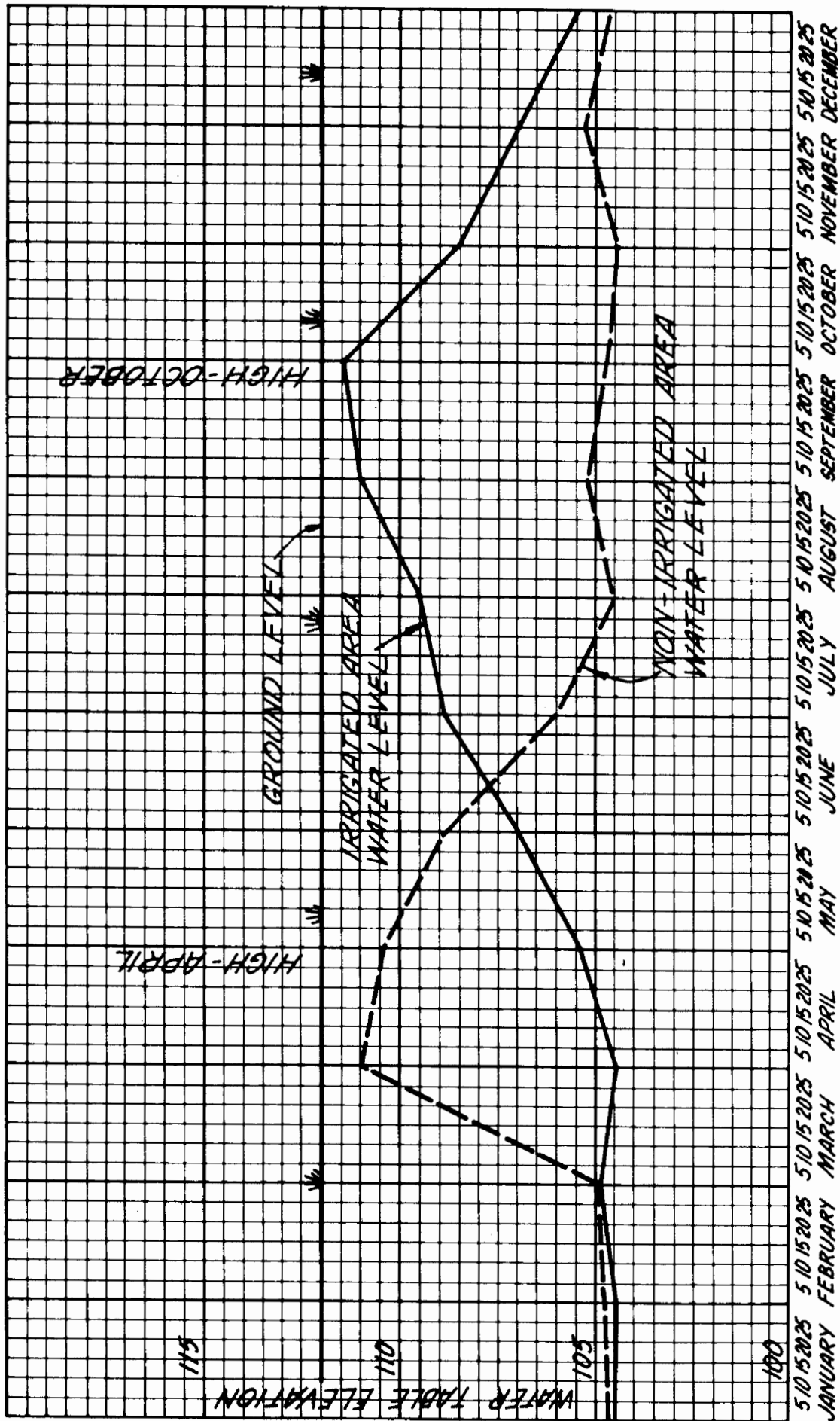

Figure 4-3, Observation well hydrograph

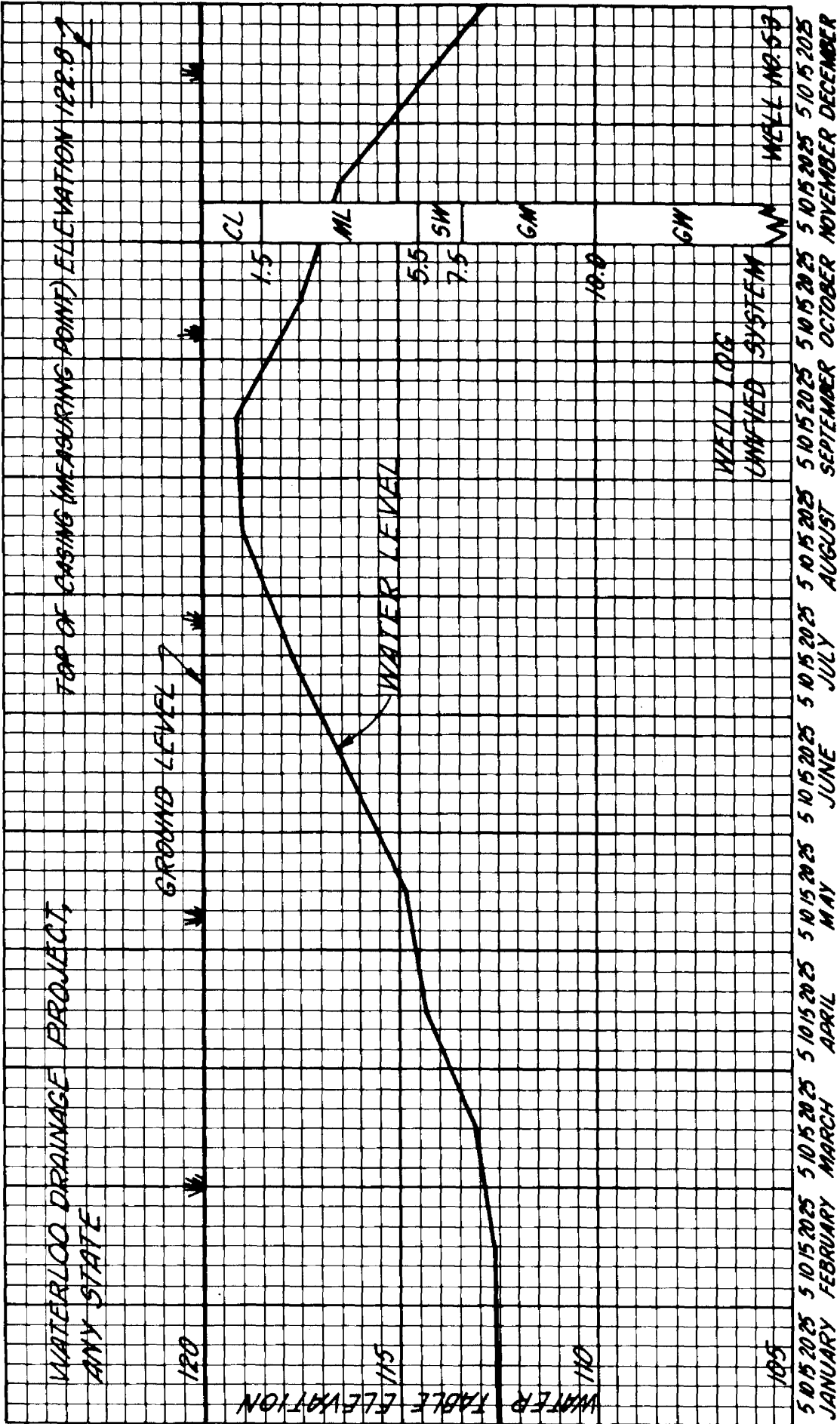

Figure 4-4, Observation well hydrograph

Ground-water contour maps

The elevation of the water table at a particular time at selected points may be plotted on the base map of the project area. These are usually plotted on a rectangular grid pattern on which ground elevations are noted, or on a contour map. By interpolation, lines of equal water-table elevation may be drawn on the map. These lines are referred to as ground-water contours and the completed map is referred to as a ground-water contour map. Such a map shows the configuration of the surface of the water table on a particular date in the area under consideration.

Figure 4-5 is an illustration of a ground-water contour map. Water-table elevations are shown on a rectangular grid pattern of 660 feet or at the corners of each 10-acre tract. By interpolation ground-water contours have been drawn on a 5-foot-vertical interval. From visual inspection the direction of ground-water flow is evident as indicated by the arrows shown. The hydraulic gradient or slope of the water-table surface varies from about 1 to 2 feet per 100 feet and can be determined for any specific area by dividing the contour interval by the scaled distance between contour lines. From visual inspection it is obvious that there is a high mound of ground water extending from the northwest corner toward the southeast corner diagonally across the field. This suggests a source of excess ground water in the northwest portion of the field or possibly in adjacent fields to the northwest.

To be of most use as a tool in planning subsurface drainage, ground-water contour maps should be superimposed on topographic maps to give the relationship between surface configuration and water-table configuration. This is illustrated in Figure 4-6 where ground-surface contours are shown as solid lines and ground-water contours are shown as dashed lines. At any specific point on the map, the depth to water table is the difference in elevation between the surface contour and the ground-water contour.

Figure 4-6 is an example of a ground-water contour map showing a high water table caused by canal seepage. This map shows an irrigated tract containing 960 acres, 100 acres of which are subject to a high water table. All land, both above and below the canal (Scott Canal), is irrigated. The wetland is located in one tract immediately below and adjacent to the canal. The "depth to water" information was developed by obtaining the difference between the elevations of surface contours and ground-water contours. The arrows on the map indicate the direction of ground-water flow which is perpendicular to the ground-water contours. From the map it appears obvious that the problem involves canal seepage. This is substantiated by the fact that there is very little wetland above the canal; that the wet area is in a fan-shaped tract adjacent to and below the canal, and that the direction of ground-water flow is outward from the area of highest water table adjacent to the canal. Having determined that canal seepage causes the wet condition, the section or sections of the canal that are seeping and will require lining or other treatment are then determined. In this example a rough location can be made by projecting the arrows showing the direction of flow to the point or points where they intersect the irrigation canal. To simplify this presentation, this example was selected to show a situation where the canal was leaking at only one point. In most cases, canals will be found to be leaking at several points, and it may be more difficult to "pinpoint" the leaky reaches; however, the general method of investigation would be the same. An examination of the materials in the canal bed would be necessary in planning remedial measures.

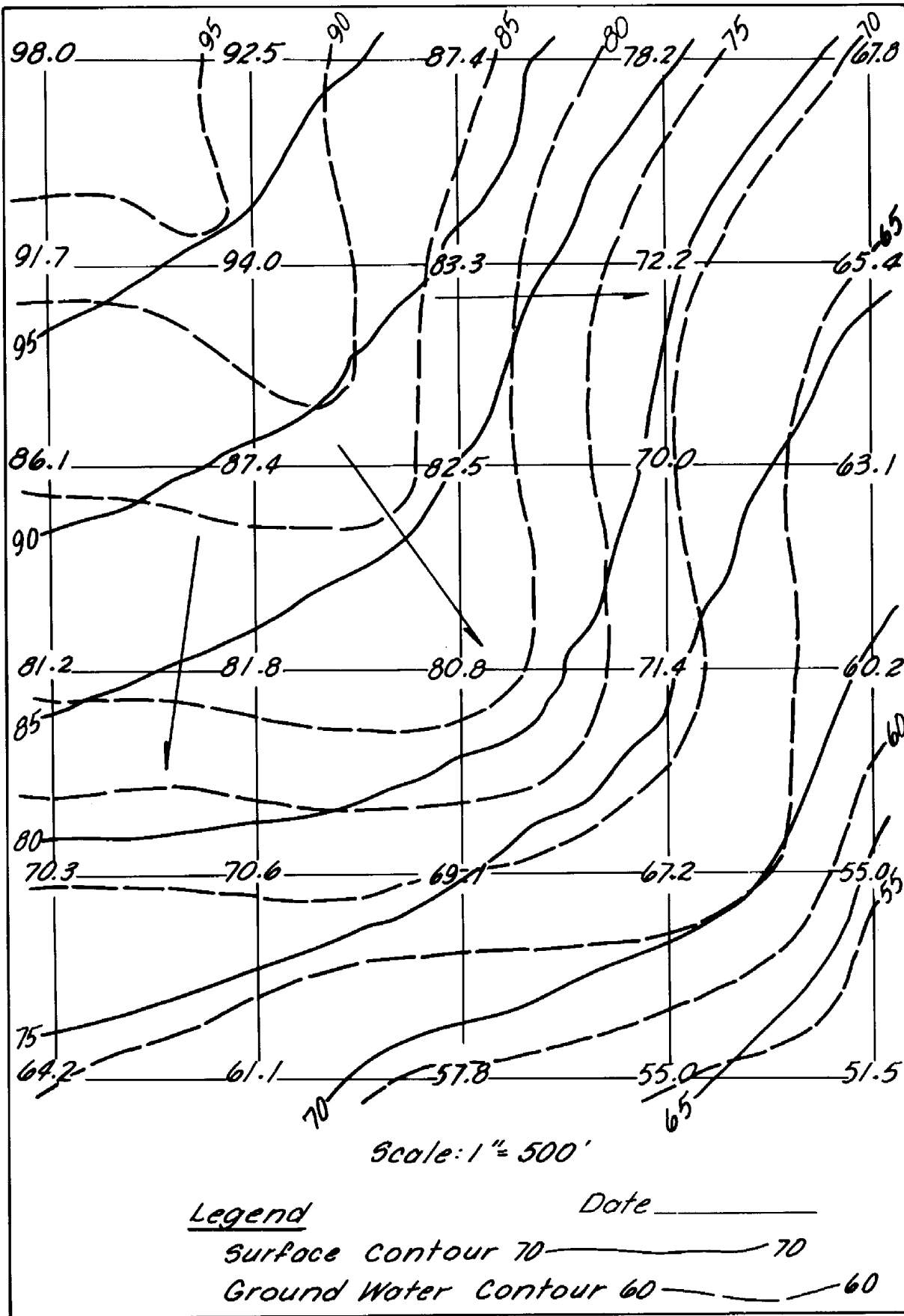

Figure 4-5, Typical ground-water contour map

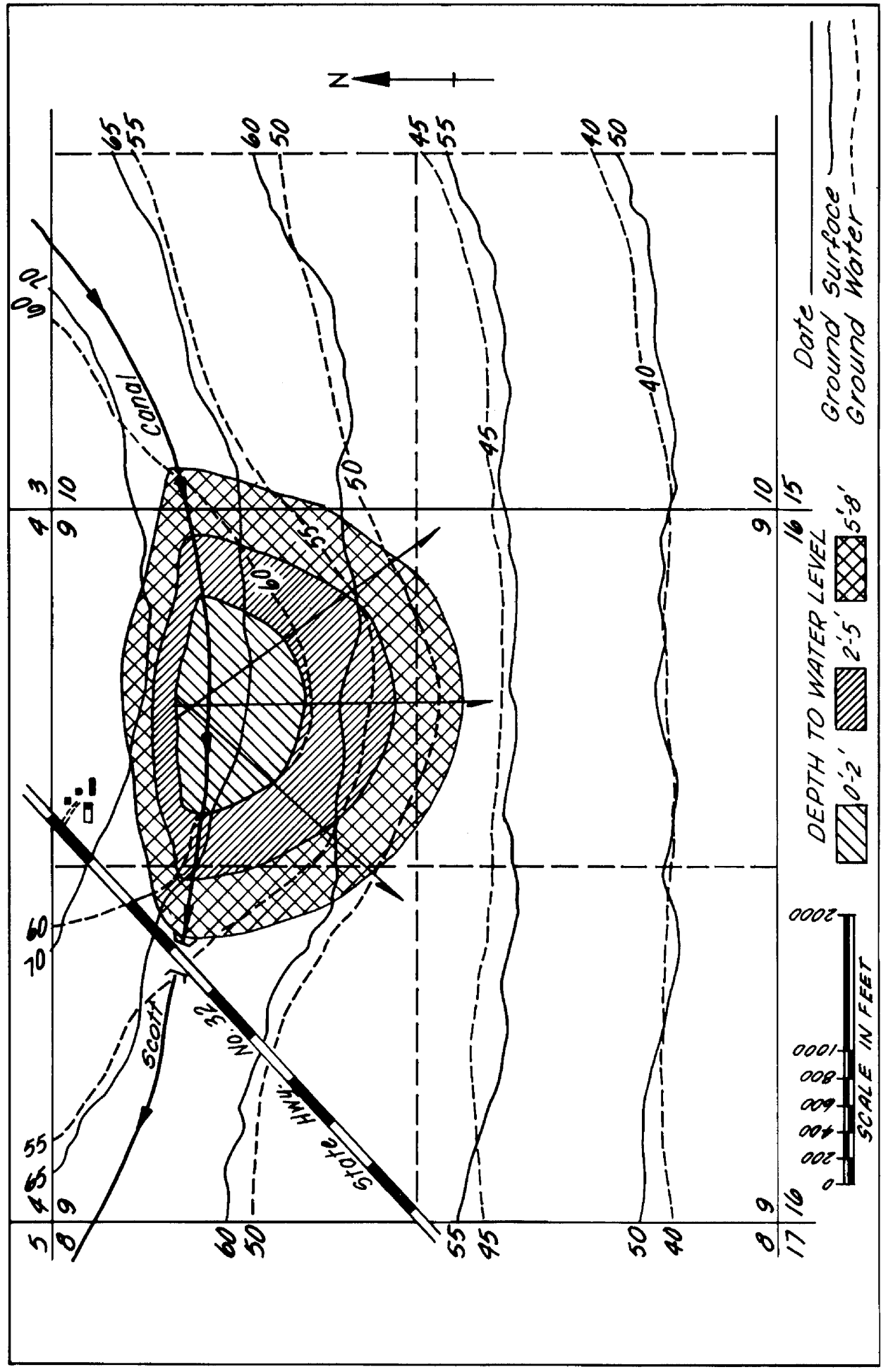

Figure 4-6, Working drawing (canal seepage)

The map shown as Figure 4-7 illustrates the use of ground-water contours in detecting and locating an underground barrier or impermeable material causing a high water table. These situations are common in alluvial flood-plain areas adjacent to major streams. When detected, these situations usually are easily corrected by installing relief drains through the impermeable barrier or immediately upslope and parallel to the barrier. Figure 4-7 shows an irrigated tract located on the flood plain of a major stream. A strip of land about 1,500 feet wide and paralleling the stream is subject to a high water table and is too wet for good production. Surface contours are shown on a 5-foot-vertical interval and ground-water contours (dashed lines) above the barrier are shown on a 1-foot interval. The direction of ground-water flow is directly to the stream. An examination of this map shows that the ground-water contours are closely spaced above the 20-foot contour. This indicates a steep water-table gradient in this area. Above or north of the 33-foot-ground-water contour the spacing of contours is wide indicating a flat gradient. This sharp break in the slope of the water-table gradient indicates the presence of less permeable material or a barrier to ground-water flow in the region of the slope break.

Figure 4-8, Section A-A, shows a cross-sectional profile of the flood-plain area as shown in Figure 4-7. It is sometimes easier to visualize these features from a profile than from a topographic map; however, the extent of the problem or problem area can be shown only on a horizontal projection.

Through the construction of this contour map and profile the position of the barrier or less permeable material has been located within broad limits. At this stage, additional borings will probably be needed in the vicinity of the barrier to make a more detailed investigation of the nature of materials present and the extent of the barrier.

The preceding examples illustrate two of the many uses of ground-water contour maps in solving difficult subsurface drainage problems. Cross-sectional profiles showing surface and water-table elevations, similar to Figure 4-8, often are helpful with investigations of localized problems. There are no exact rules governing the methods to be used in each situation. The drainage engineer must analyze each problem individually and set up a schedule for obtaining the information and data needed to develop the profile and contour maps required to analyze the problem.

Depth to water-table map

The depth to water, i.e., difference in elevation between the ground surface and the water table, should be plotted at selected points on a suitable base map. The lines of equal depth to water table are drawn. The completed map, sometimes referred to as an "isobath map," will show areal delineation of depth to water, which is usually the criteria for determining the need and extent of the wet area needing drainage. Figures 4-6 and 4-7 both illustrate this type of map. Areas with fixed ranges of depth to water table may be delineated and crosshatched or colored to show a graphic picture. A map of this kind is a valuable aid in discussing the project with landowners and is sometimes used as a basis for determining assessments for construction by the local sponsoring groups.

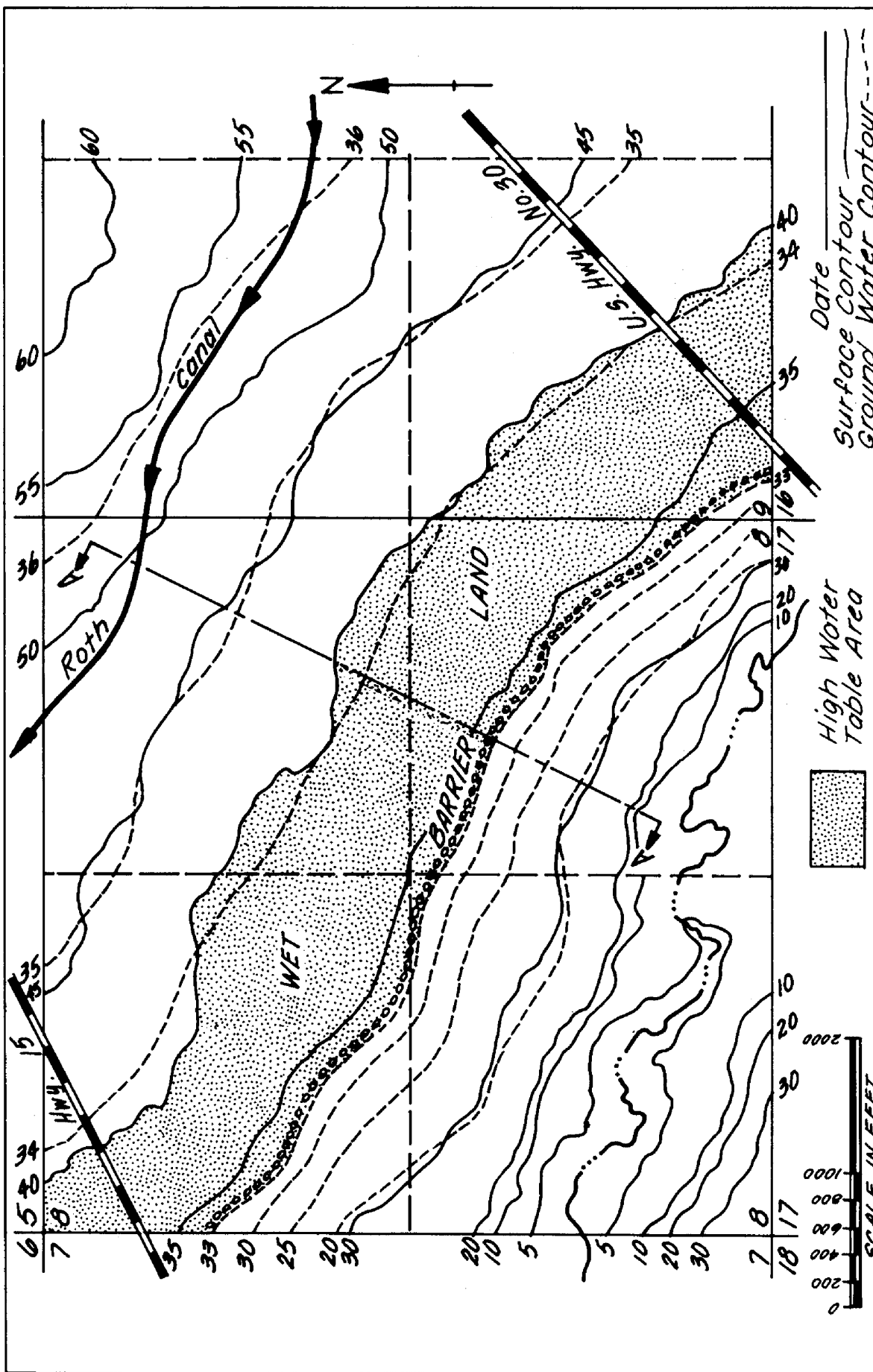

Figure 4-7, Surface contour above ground-water contour

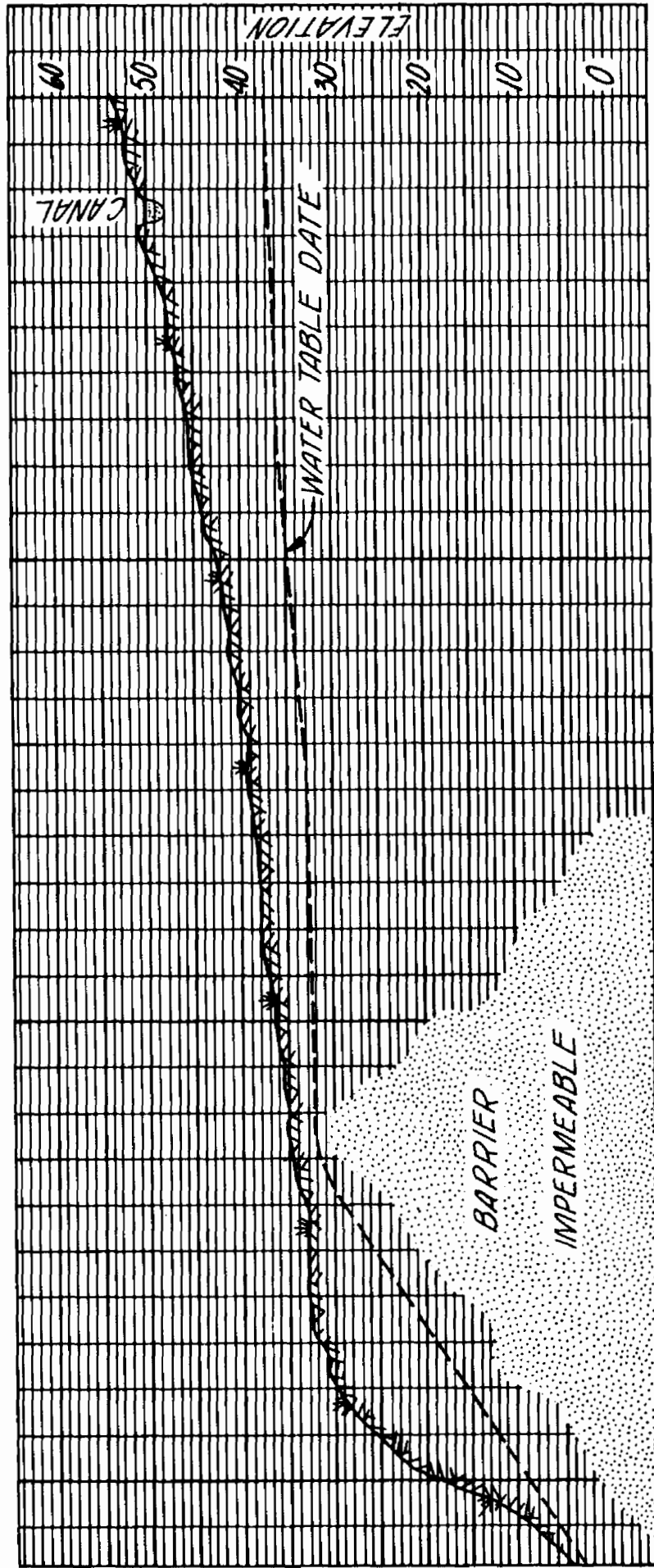

Figure 4-8, Profile section A-A, Figure 4-7

Classification of subsurface drainage

General

From a functional point of view, subsurface drainage falls into two classes: relief and interception drainage. Relief drainage is used to lower a high water table which is generally flat or of very low gradient. Interception drainage is to intercept, reduce the flow, and lower the flowline of the water in the problem area. In planning a subsurface drainage system, the designer must evaluate the various site conditions and decide whether to use relief or interception drainage.

Relief drainage

Open ditches. - Ditches used for subsurface drainage may carry both surface and subsurface water. Because of their required depth they have the capacity for a wide range of flow conditions. Ditches are best adapted to large flat fields where lack of grade, soil characteristics, or economic conditions do not favor buried drains. The advantages in using ditches include the following:

1. They usually have lower initial cost than drains.
2. Inspection of ditches is easier than inspection of drains.
3. They are applicable in some organic soils where drains are not suitable due to subsidence.
4. Ditches may be used on a very flat gradient where the permissible depth of the outlet is not adequate to permit the installation of drains having the minimum required grade.

The disadvantages in using ditches are as follows:

1. Ditches require considerable rights-of-way which reduce the area of land available for cropping. This is particularly applicable in unstable soils where flat side slopes are required.
2. Ditches usually require more frequent and costly maintenance than drains.

Buried drains. - Drains refer to any type buried conduit with open joints or perforations which collect and/or convey drainage water. Drains may be fabricated from clay, concrete, bituminized fiber, metal, plastic, or other materials of suitable quality. Drains, if properly installed, require little maintenance. They are usually preferred by landowners as they are buried and no land is removed from cultivation and maintenance is considerably less than for ditches.

The topography of the land to be drained and the position, level, and annual fluctuation of the water table are all factors to be considered in determining the proper type of drainage system for a given site. Relief drainage systems are classified into four general types: parallel, herringbone, double main, and random. (Refer to Figure 4-9).

Parallel system. - - The parallel system consists of parallel lateral drains located perpendicular to the main drain. The laterals in the system may be spaced at any interval consistent with site conditions. This system is used on flat, regularly shaped fields and on soils of uniform permeability. Variations of the parallel system are often used with other patterns. (Figure 4-9a).

Herringbone system. - - The herringbone system consists of parallel lateral drains that enter the main drain at an angle from either or both sides. This system usually is used where the main or submain drain lies in a depression. It also may be used where the main drain is located in the direction of the major slope and the desired grade of the lateral drains is obtained by varying the angle of confluence with the main. This pattern is used with other patterns in laying out a composite pattern on small or irregular areas. (Figure 4-9b).

Double-main system. - - The double-main system is a modification of the herringbone system and is applicable where a depression, which is frequently a natural watercourse, divides the field to be drained. Occasionally the depressional area may be wet because of seepage coming from the higher ground. Placing a main drain on each side of the depression serves a dual purpose; it intercepts the ground water moving to the natural watercourse and provides an outlet for the lateral drains. (Figure 4-9c).

Random system. - - A random system of drains is used where the topography is undulating or rolling and contains scattered isolated wet areas. The main drain, for efficiency, is usually placed in the swales rather than in deep cuts through ridges. If the individual wet areas are large, the arrangement of submain and lateral drains for each area may utilize the parallel or herringbone pattern to provide the required drainage. (Figure 4-9d).

Pumping system (ground-water removal). - This type of removal applies to deep well drainage where the drawdown is extensive and does not include shallow water-table control such as obtained by pumping muck or tidewater areas. The objective of all subsurface drainage work is to lower and maintain the water table at some level suitable for proper crop growth. This is usually accomplished by the installation of relatively deep subsurface drains. Water-table levels also may be controlled by pumping from the ground-water reservoir to lower and maintain the desired water-table level. In some irrigated areas where irrigation water is obtained from wells, the practices of irrigation and drainage both may be effected by the pumping of wells. This combination practice is limited to those areas with low salinity where it is possible to maintain a proper salt balance. In salty areas where pumping is used to effect drainage and where the quality of the drain water is poor, the drain water usually is discharged into a drainage outlet and not directly reused for irrigation. In some cases it is possible to mix the drain effluent with water of high quality and thereby obtain water suitable for irrigation.

The investigations necessary for planning a drainage facility, using pumps to lower the water-table level, can be quite complex. Detailed information on the geologic conditions and the permeability of soil and subsoil materials are very important. Design involves anticipating what the shape and configuration of the cone of depression will be after pumping. This, in turn, involves spacing of wells to position properly their areas of influence and obtain the desired drawdown over the area to be drained. Usually it is desirable to install test wells to determine the drawdown and spacing of wells. Consultation with a geologist is desirable.

Past experience with this type of drainage installation indicates that, in general, pumping from wells is costly and it is difficult to obtain a satisfactory benefit-cost ratio. Consideration for this type of facility should be limited to high-producing lands with a high-return value per acre.

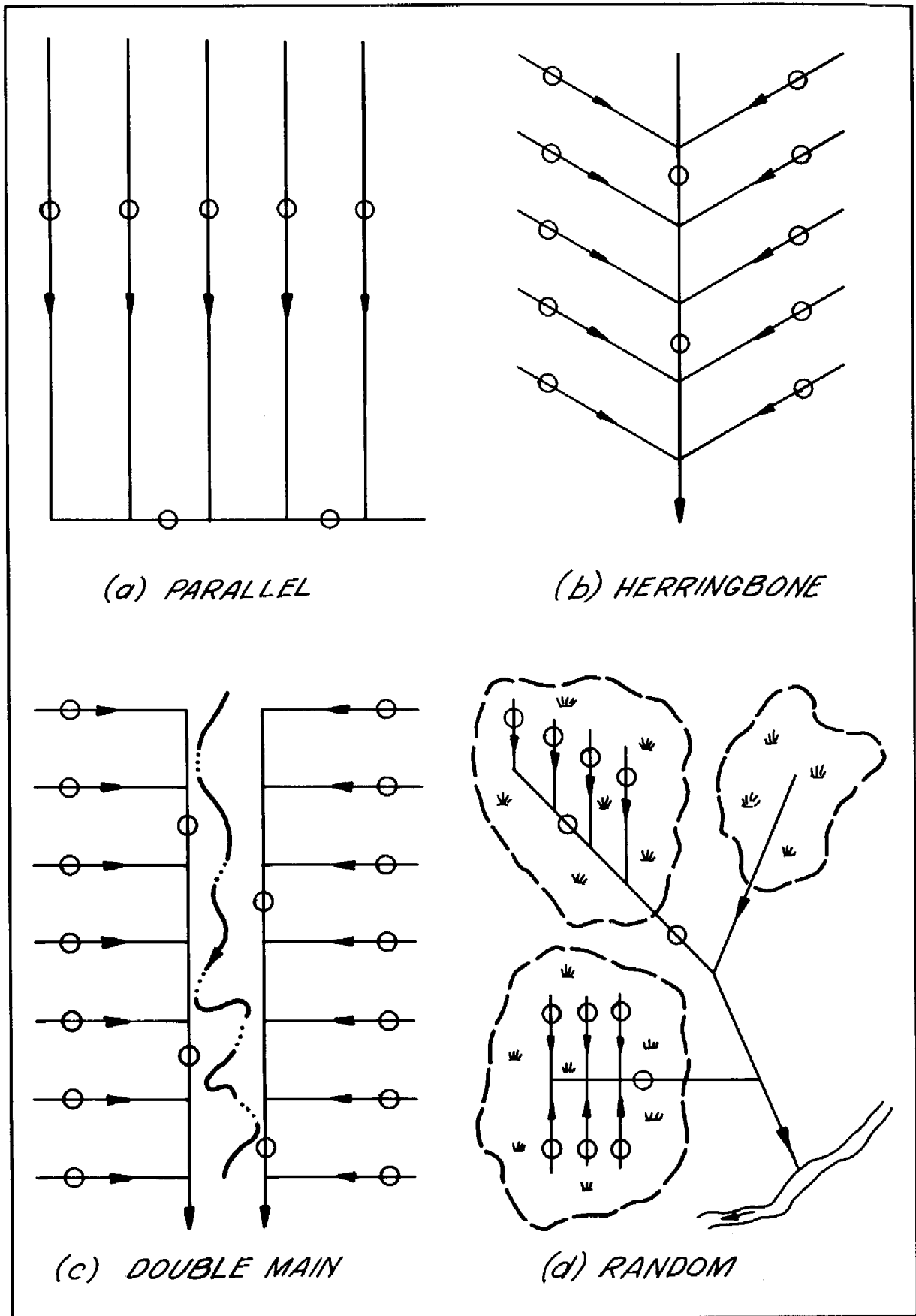

Figure 4-9, Types of drainage collection systems

Combination system. - Combination systems or dual-purpose systems are names that have been given drainage systems that provide both surface and subsurface drainage. In this type of system any combination of open ditches and buried drains may be used. In areas with soils of low permeability which require close spacing of buried drains, it is common practice to use drainage field ditches for surface collectors, drains for subsurface collectors, and ditch-type drainage mains and laterals for disposal. In soils of high permeability such as Indiana and Michigan sands and some coastal plain soils, a field-border ditch for surface water collection is all that may be needed. Drop structures are required where surface collectors discharge into deep open ditches. Buried drains are seldom used to collect or dispose of surface water. The reasons for this are (a) surface waters usually carry debris which may lodge in the drain and cause a plug to form, and (b) surface flows are subject to large variations which dictate a large and expensive drain.

Mole drains. - Mole drains are unlined, approximately egg-shaped earthen channels, formed in highly cohesive or fibrous soil by a moling plow. The moling plow has a long blade-like coulter to which is attached a cylindrical bullet-nosed plug, known as the mole. As the plow is drawn through the soil, the mole forms the cavity, at a set depth, parallel to the ground surface over which the plow is drawn. Heaving and fracturing of mineral soil by the coulter and mole leave fissures and cracks which open up toward the mole and coulter slit. These provide escape routes through the soil profile and into the mole cavity for water trapped at the surface or water that has percolated into the soil.

Mole drains, when properly installed in locations with soils suitable for them, provide drainage for 3 to 5 years and may, with diminishing effectiveness, provide drainage for as much as 5 years longer.

Cultivation of moled lands with heavy equipment reduces the effective life of such drains.

Vertical drains. - Vertical drains or drainage wells, as they are frequently called, have been used as outlets for both surface and subsurface drains. They have been used where gravity outlets were not available or where the cost of obtaining gravity outlets was prohibitive.

Vertical drains must penetrate a suitable aquifer which is capable of absorbing the drainage flow. Investigations for vertical drains must be in sufficient detail to determine that such an aquifer is present and that it is capable of absorbing the expected drainage discharge for an indefinite period of time. This requires a geologic determination made in conjunction with a geologist. It is usually necessary to make a test boring or borings to determine the magnitude, thickness, depth, and extent of the aquifer in question. Laboratory work may be required to determine the physical and chemical properties of the aquifer material.

Vertical drains are wells in which the direction of flow is reversed. Most of the design principles and criteria applicable to water wells are applicable to vertical drains. The major difference is that relatively clean ground water is pumped from water wells; whereas, drainage water discharged into vertical drains may contain significant quantities of salt, sediment, and debris. Unless these pollutants are removed from the drainage effluent before it enters the vertical drain, they tend to plug and seal the drain. Service experience with vertical drains has been disappointing because of the large

percent of vertical drains that seal-up and become ineffective in a relatively short period of time.

Drainage water that is discharged into underground aquifers usually contains pollutants in solution, in addition to the sediment and debris mentioned above. These pollutants may percolate into other aquifers or areas where wells are used for a domestic water supply. For this reason there is danger of contaminating water supplies and most states working with the Public Health Service have enacted laws controlling this practice. Some states forbid the use of drainage wells and others require that a permit be obtained.

Interception drains

General. - Interception drains may be either open ditches or buried drains. Proper location of either type is very important. The location and depth required usually are determined through extensive borings and ground-water studies.

Open ditches. - The ditch type interceptor may serve to collect both surface and ground-water flow. It must have sufficient depth to intercept the ground-water flow. Such ditches usually have excess capacity at the required depth. The interception ditch frequently is used to intercept the surface and ground-water flow at the base of a slope.

Buried drains. - Peculiar or unusual subsurface formations or ground-water conditions may be responsible for a high water table in certain local areas. Likewise, abrupt changes in topographic features may cause certain areas to be subject to a high water table. These situations are difficult to describe. Figures 4-10 through 4-12 are diagrammatic sketches of a few combinations of subsurface materials, topography, and ground-water conditions which may cause a high water table.

Figure 4-10 is a sketch of a cross section of one-half of a valley area. This illustrates an interception drain located at the base of hill land or at the base of a higher terrace or bench. This is a common situation in large stream valleys where the valley lands are subject to seepage from uplands. Often high benches or terraces are subject to seepage from higher land. Many investigations of these situations have shown that wet or high water-table areas usually occur near the base of the terrace and extend for some distance toward the river or stream. Ground-water investigations generally disclose that the water-table surface is close to a straight line or flat curve extending from the water surface in the stream to some distant point beneath the terrace or bench. The wet area exists because of an abrupt change in topography at this point which brings the land surface near to, or in contact with, the water-table surface. The corrective measure, as indicated, is to lower the water table in this area by an interception drain. Some open interception ditches are susceptible to damage from flood flows, causing erosion or channel changes, and use of drains instead of open ditches may avoid such hazards.

Figure 4-11 is a sketch to illustrate an interception drain located upslope above a barrier of impermeable material. Under natural conditions this barrier causes a reduction in the depth or thickness of the aquifer, and in turn, causes the hydraulic grade line or water-table surface to "daylight," or rise to or near the ground surface. This causes a wet or seep area near the barrier. This situation is often found in alluvial flood plains where ancient channel changes have built up barriers of fine-grained sediments, sometimes referred to as slack-water deposits. This condition is difficult

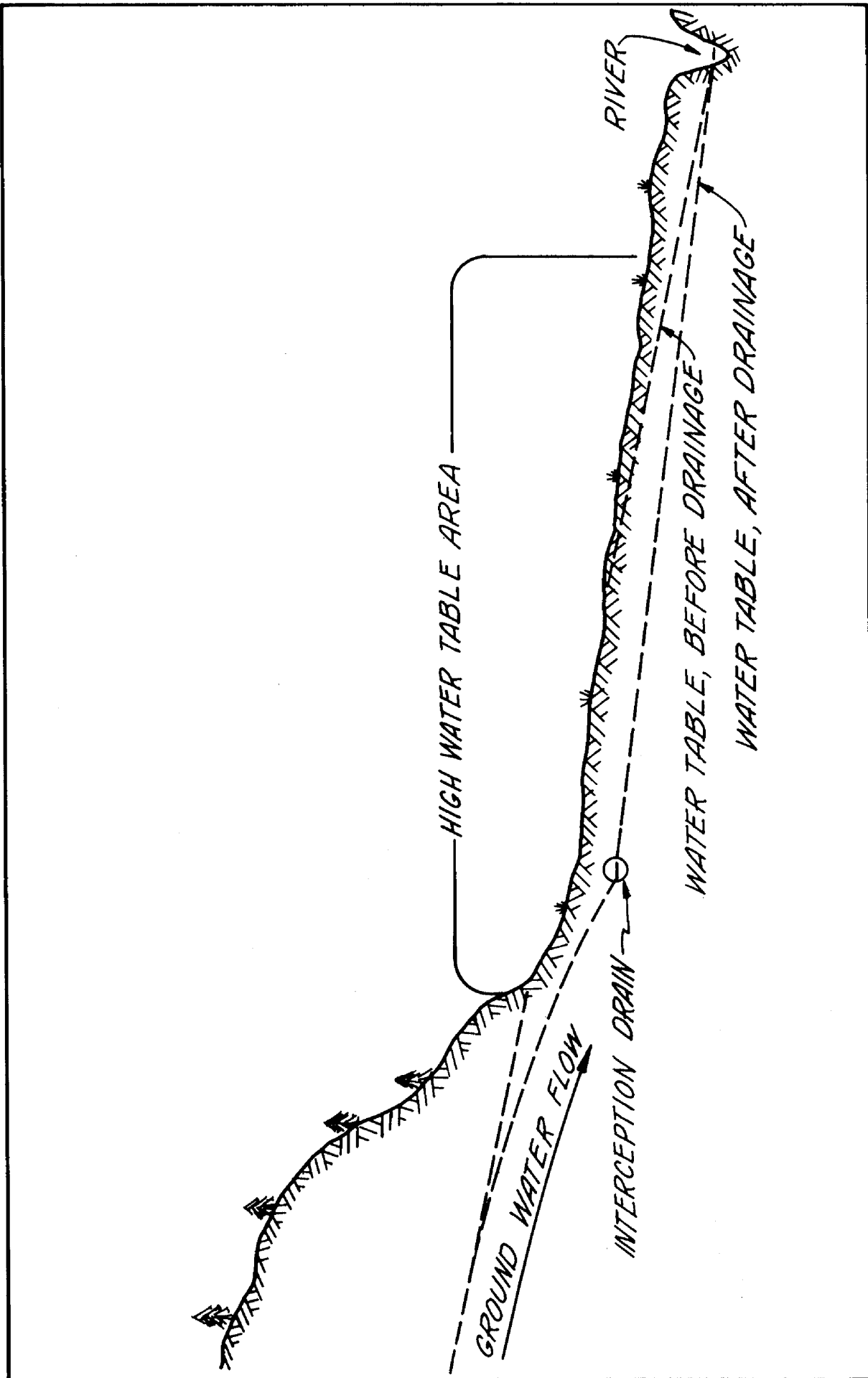

Figure 4-10, Interception drain in a valley area

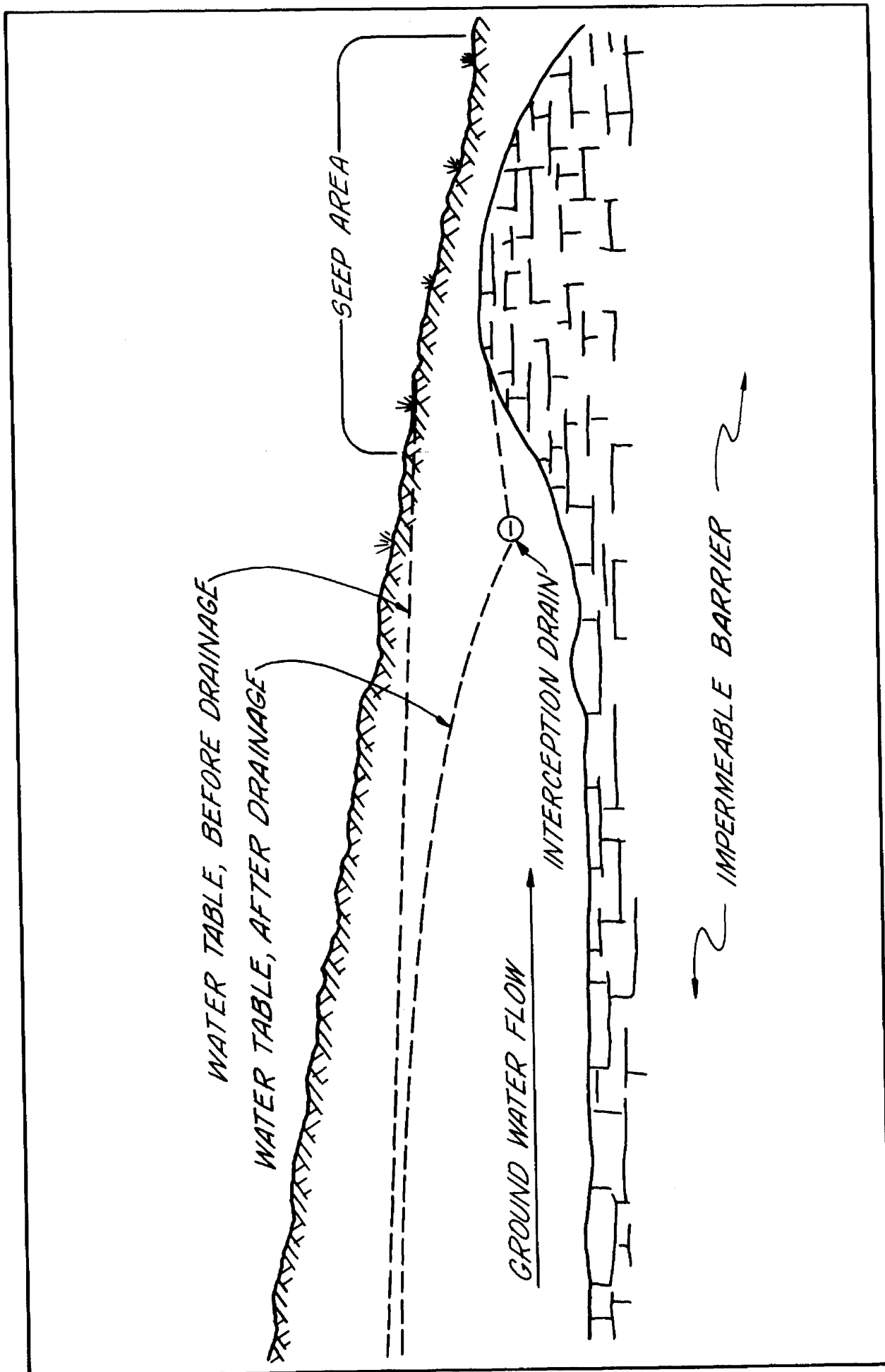

Figure 4-11, Interception drain for barrier condition

to detect and usually requires extensive subsoil explorations. The presence of unexplainable wet areas surrounded by dry areas suggests such a non-conformity in subsoil material. The corrective measure may be a drain just upslope from the barrier and paralleling it as suggested in the sketch.

Figure 4-12 illustrates an interception drain located at the base of a permeable layer, sandwiched between layers of less permeable material. The permeable layer outcrops, causing a seep that may affect a considerable area below the outcrop. This is common in formations that are highly stratified and have an exposed outcrop. Under natural conditions, the permeable layer may be carrying considerable ground water with a hydraulic grade line that intercepts the ground surface at some point in the outcrop area causing a natural seep. An interception drain should be located as indicated, at the base of the permeable material, to collect the flow from the aquifer, and prevent seepage at the ground surface.

Many other situations could be cited which would illustrate variations in drainage problems. It is obvious that there can be no fixed rules or procedures for dealing with these problems. The drainage engineer must make a thorough investigation of the subsurface and ground-water conditions and then make an analysis of these factors based on sound hydraulic principles as they are pertinent to drainage.

Outlets for subsurface drainage

An outlet for the drainage system must be available for gravity flow or by pumping. The outlet must be adequate for the quantity and quality of the effluent to be disposed of without causing damage to other areas and with minimum deterioration of the water quality in the outlet.

An open-ditch outlet for gravity flow from a buried drain should permit discharge from the drain above the elevation of normal low flow in the outlet. Interruption of flow from the drain due to storm runoff in the outlet should not occur so often and with such duration that the rate of ground-water drawdown by the buried drain would fail to meet the design requirements. When this condition exists, pumping the flow from the buried drain should be considered.

Special situations

Use of relief wells. - A high water table may be caused by seepage under hydrostatic pressure in a pervious strata located below a less pervious strata. The presence of hydrostatic pressure in seepage spots can be detected by boring holes in the seepy area. Water may rise in the hole nearly to the ground surface and may even overflow as from a flowing well.

A relief drain employing a relief well to lower a high water table is illustrated in Figure 4-13. This sketch illustrates a condition where very slowly permeable subsoil and substratum materials, which extend below feasible drain depth, are underlain by permeable material under sufficient hydrostatic pressure to maintain the water-table level at or near the ground surface. By installing the relief wells into the permeable material, it is possible to lower the water-table level by the amount of the effective head created. The effective head is the difference in elevation between the water-table level before drainage and the water surface in the drain. The operating head is the effective head less friction loss, entrance losses, etc. in the relief wells. The effective head should be about 5 feet or more before attempting this type of installation. The spacing of relief wells must be on a trial basis for any individual case. Relief wells should be added to the line until

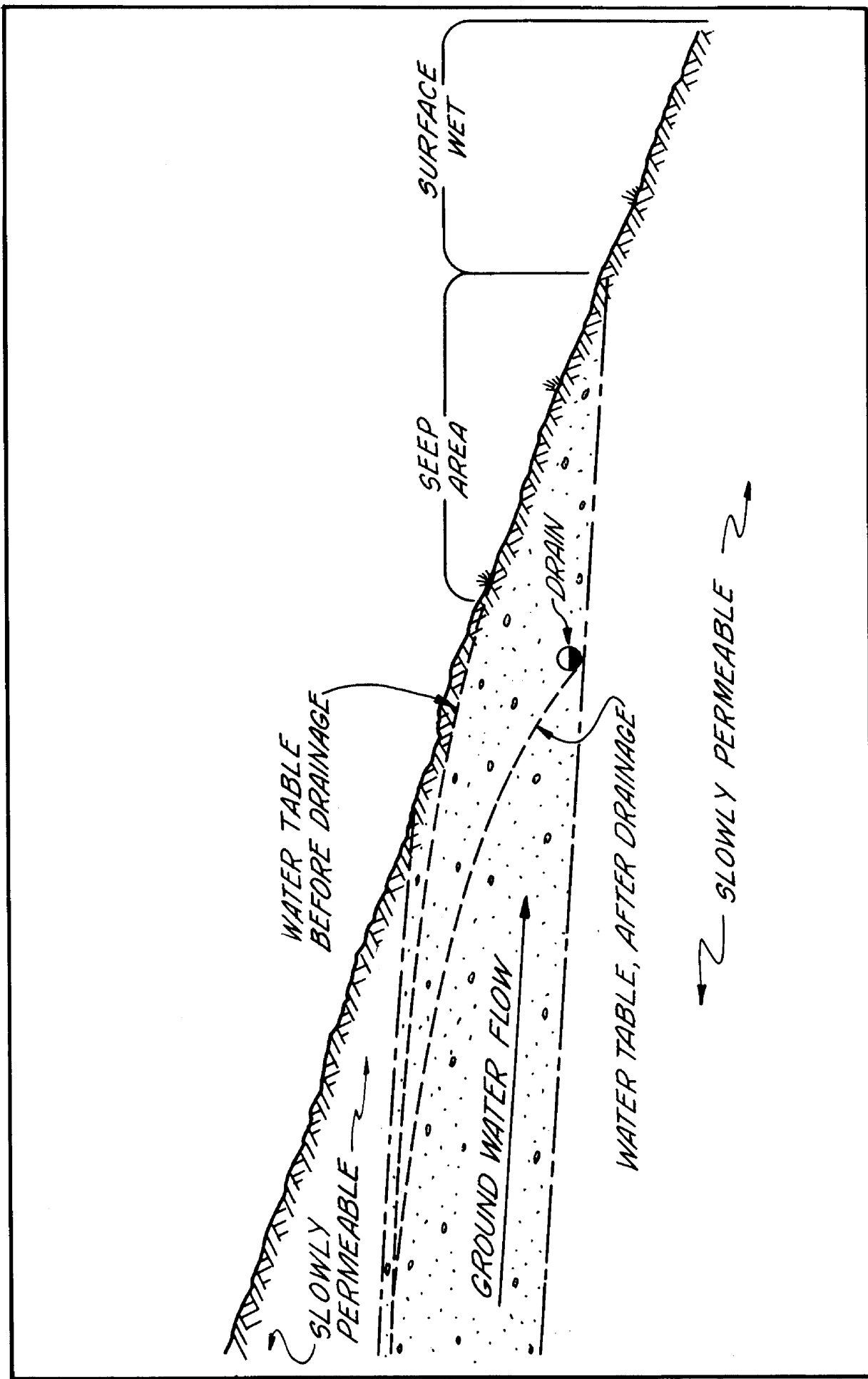

Figure 4-12, Interception drain at outcrop of aquifer

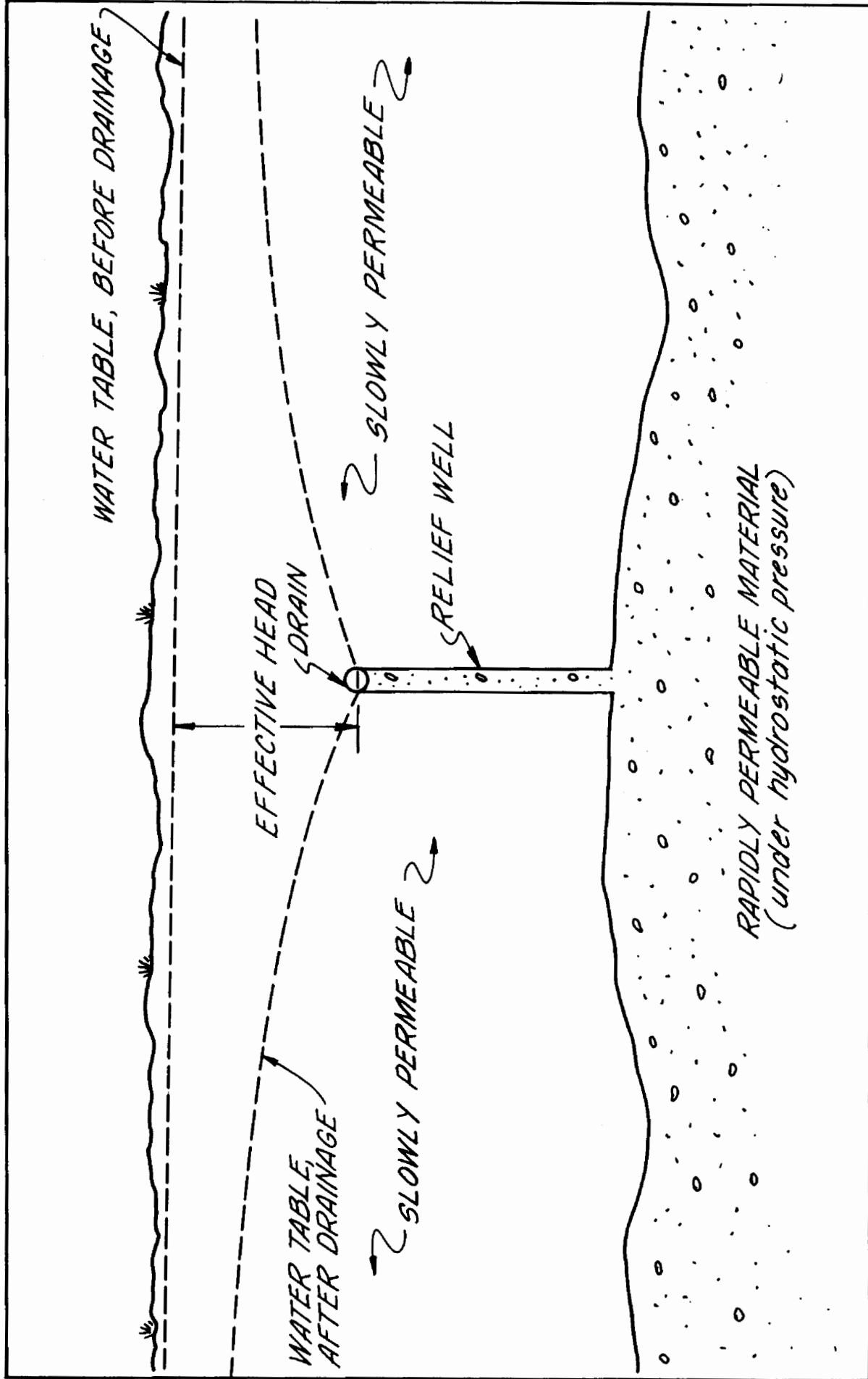

Figure 4-13, Relief well installation

hydrostatic pressures are reduced to near zero at the water surface in the drain. Investigations leading up to an installation of this kind must be thorough. The use of relief wells is restricted to special cases where complete information is available on subsurface materials and ground-water conditions.

The sketch shown as Figure 4-14 illustrates a condition where a constricted aquifer forces the water table to the ground surface. The subsurface materials present are a slowly permeable sediment containing a lens or stratification of very permeable materials serving as an aquifer for ground-water flow. Due to the constriction or "pinching-off" of the aquifer formation, its capacity is reduced and sufficient hydrostatic pressure develops to cause the water table to rise to or near the surface or "daylight" as shown. Situations of this type are difficult to detect and require careful subsurface exploration. Upon examination, the wet area usually appears as a seep area below a definite line of seepage which can be traced through the field.

Salt-water intrusion in coastal areas. - When planning drainage in areas in close proximity to sea coasts, certain precautions must be considered in regard to salt-water intrusion. Beneath coastal areas, the normal movement of fresh ground water toward the sea usually prevents landward intrusion of the denser sea water; however, pumped well drains or pumped surface and subsurface drainage can reverse this situation. If this happens, the consequences can be serious because land once subjected to salt-water intrusion is difficult to reclaim.

Guidelines for prevention. - - In coastal areas salt water is present in underground strata at a depth equal to about forty times the height of fresh water above sea level (5). This is given by the Ghyben-Herzberg relation (refer to Figure 4-15), which expressed mathematically, is as follows:

$$z = \frac{P_f}{P_s - P_f} (h) \quad (\text{Eq. 4-1})$$

where:

z = The distance from mean sea level (MSL) to the fresh water-salt water interface.

P_f = The density of fresh water.

P_s = The density of sea water.

h = The head of fresh water above MSL. (See Figure 4-15)

assuming:

$$P_f = 1.000 \text{ g/cm}^3$$

$$P_s = 1.025 \text{ g/cm}^3$$

$$z = \frac{1.000}{1.025 - 1.000} (h)$$

$$z = 40h$$

This relationship is only approximate as the density of sea water varies with temperature and the salts present; however, the ratio of 40.0 to 1.0 is adequate, as a general rule, for the purposes discussed here.

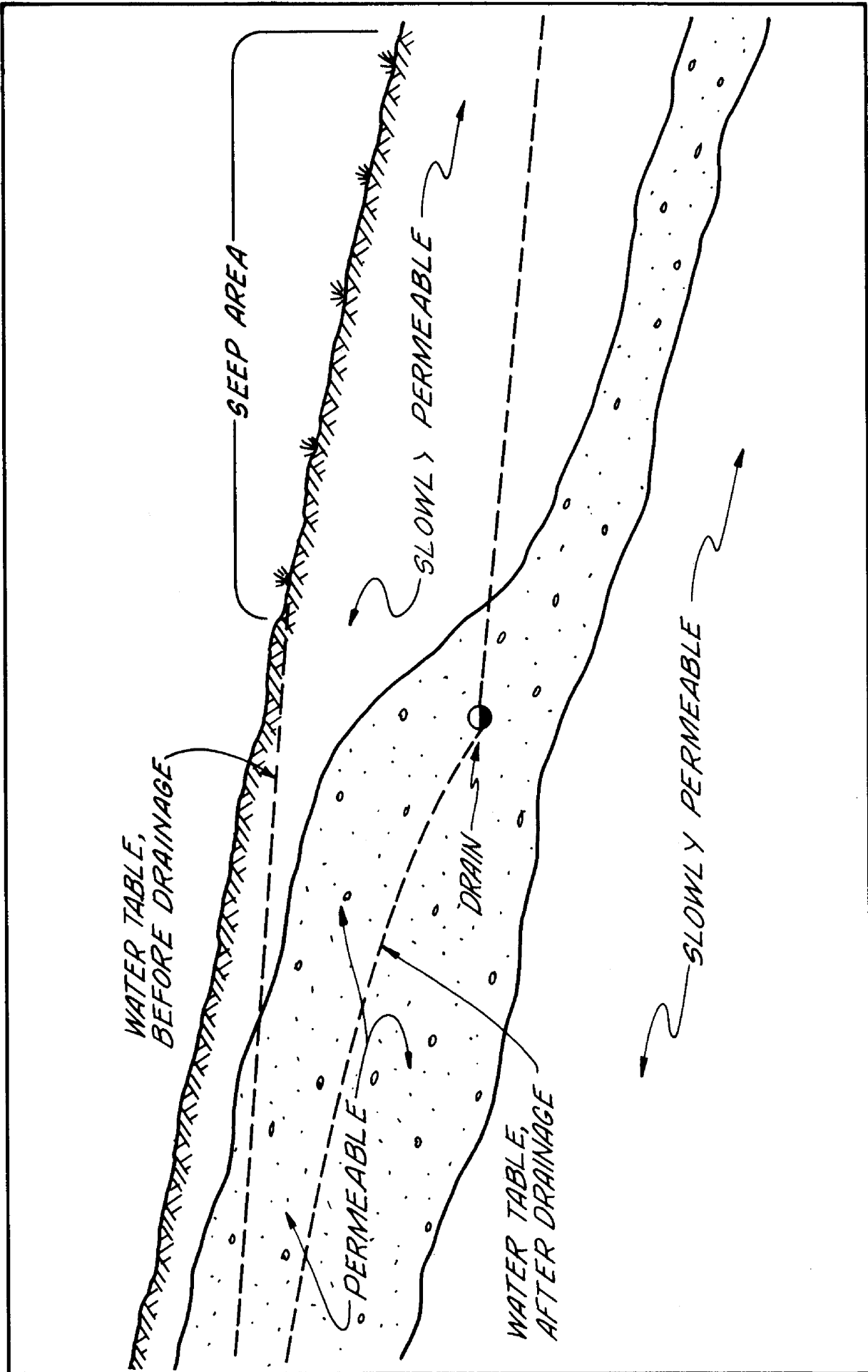

Figure 4-14, Interception drain in a constricted aquifer

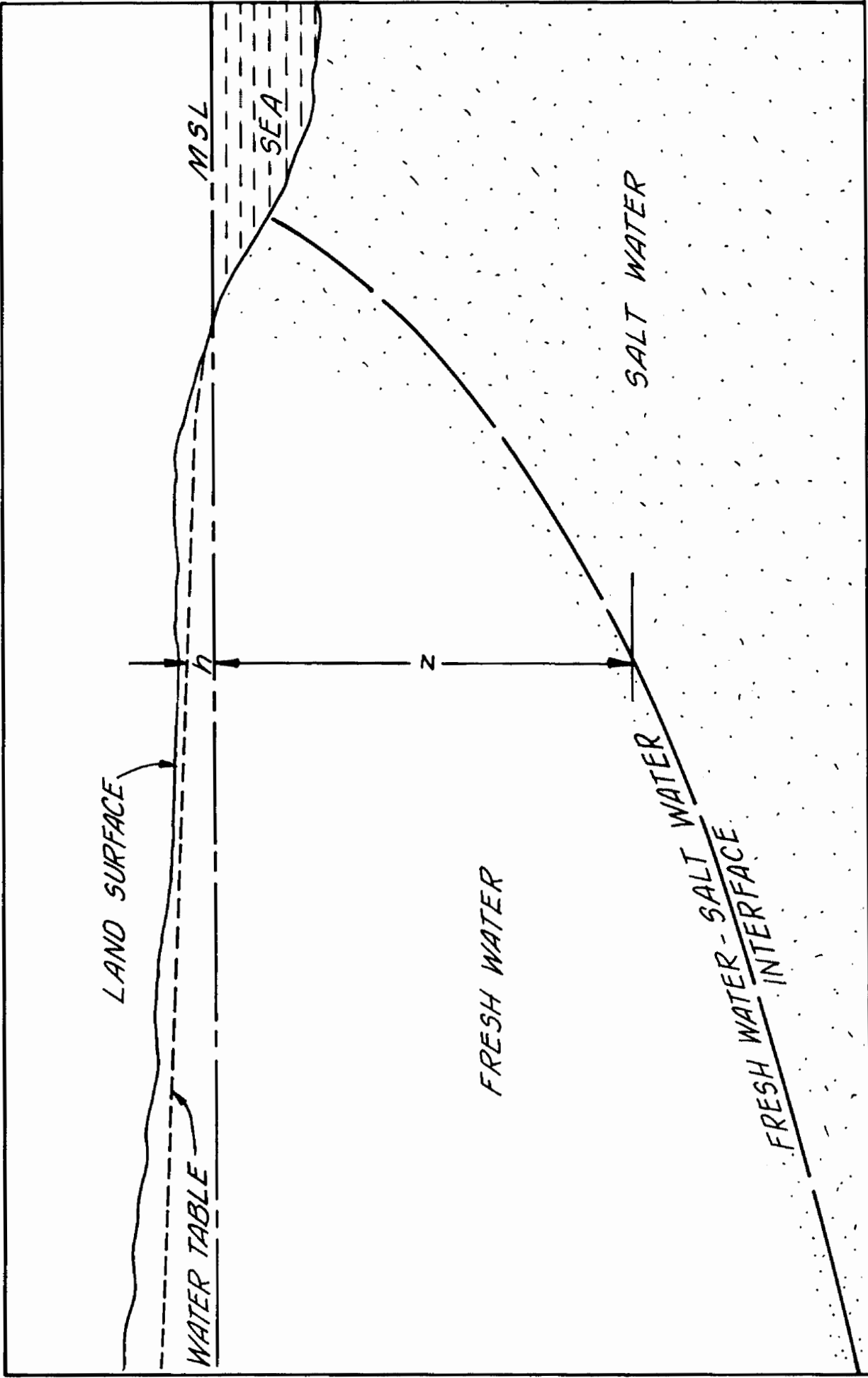

Figure 4-15, Fresh water-salt water conditions

From the prior discussion it is apparent that in coastal areas, lowering of the water table 1 foot will cause a 40-foot rise in the fresh water-salt water interface. Lowering of the water table to mean sea level will bring the interface up to mean sea level which will in most cases render the land salty and unfit for agricultural use.

As a general guide for use in planning pumped well drains near the coast, wells should not pump from below mean sea level. Interior basin wells should bottom above the expected fresh water-salt water interface with the anticipated drawdown. Wells should be designed and developed for minimum drawdown and be located so that drawdown is distributed as widely as possible.

Planning a subsurface drainage system (example)

The following example is an illustration of the use of a topographic map, water-table contour map, and a depth to water-table map in planning a drainage system for a drainage problem area. There are several ways a solution to a similar problem might be worked out. One way is to prepare a working map of the affected area showing topographic and ground-water conditions. Soil and subsoil conditions also may be shown on the map, but it is usually better to indicate these on a separate map or tabulation to avoid too much detail on one map. Transparent overlays, each showing separate features, are helpful working tools. A base map showing cultural and topographic features can be prepared on drawing paper and overlays on transparent sheets added to show soil, subsoil, substratum, and ground-water conditions. Through this procedure working maps are compiled which show the pertinent physical conditions necessary for the analysis of drainage problems. The following is a discussion on the above method showing how such a working map might be developed and used. Although the example is that of an irrigated farm the same procedure is used on nonirrigated farmland.

Figure 4-16 shows a topographic map of an irrigated farm containing about 480 acres. Part of this farm is wet and subject to a high water table and needs subsurface drainage. This map shows the usual features that would be shown on any topographic map of an irrigated area. It will be noted that the main irrigation canal and a few irrigation field ditches are shown. Surface contours are drawn on a 5-foot-vertical interval. This topographic map will serve as a base for the working map to be developed.

Table 4-3 is a tabulation of ground-water information from 23 observation wells on the 480-acre farm. The first three columns on the left show well number, ground-surface elevation at the well, and top of casing or "measuring point" elevation for each well. These are data that can be compiled after establishing wells and completing level surveys. This part of the table should be set up before making measurements of depth to water table in the wells. The depth to the water table (distance from the ground surface to the water-table level) and the water-table elevation reduced to a standard datum are shown for each well for the period of record, May through September. The period of record, or the period over which well measurements are made, varies from project to project. However, May through September was adequate to select a general high water-table condition in this particular example. In reviewing the table it will be noted that the highest water-table reading for each well, regardless of the month in which it occurred, has been marked by parentheses. The number in parentheses at the bottom of the table indicates the number of wells which showed their highest reading in each month during the period of record. It is noted that August, during which 10 of the 23 observation wells showed the highest water-table level, is the critical month

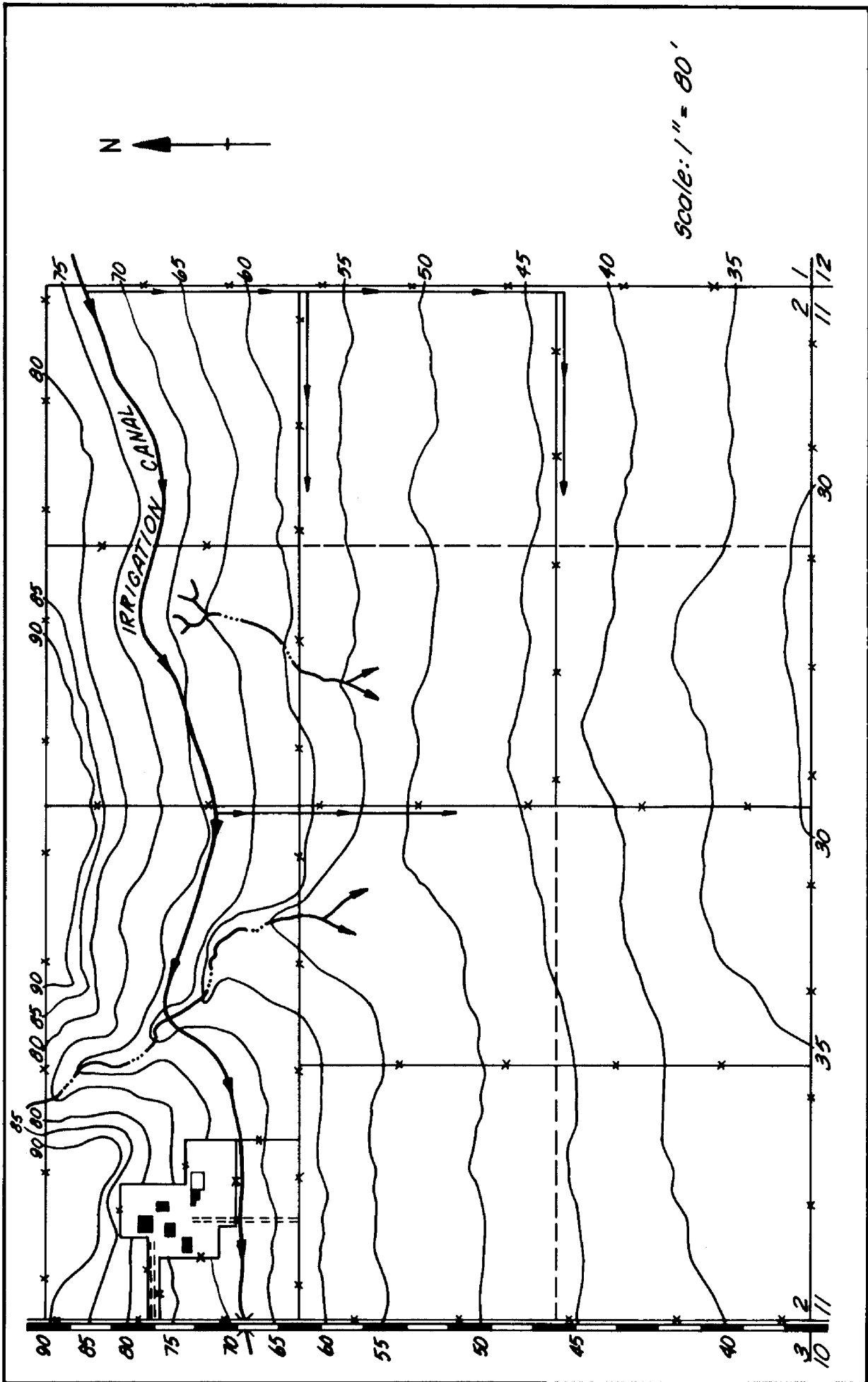

Figure 4-16, Working map--topography

Table 4-3, Observation well data

| Well (No.) (1) | Elevation | | May | | June | | July | | August | | September | |
|----------------|--------------------|-------------------|--------------------------|---------------------------|--------------------------|---------------------------|--------------------------|---------------------------|---------------------------|----------------------------|---------------------------|----------------------------|
| | Ground surface (2) | Top of casing (3) | Depth to water table (4) | Water table elevation (5) | Depth to water table (6) | Water table elevation (7) | Depth to water table (8) | Water table elevation (9) | Depth to water table (10) | Water table elevation (11) | Depth to water table (12) | Water table elevation (13) |
| | Feet | Feet | Feet | Feet | Feet | Feet | Feet | Feet | Feet | Feet | Feet | Feet |
| 1 | 94.3 | 96.8 | | | | | 18.0 | 76.3 | 19.1 | 75.2 | 20.1 | 74.2 |
| 2 | 78.2 | 81.1 | (3.4) | (74.8) | 11.2 | 67.0 | 8.4 | 69.8 | 10.2 | 68.0 | 10.8 | 67.4 |
| 3 | 93.7 | 95.7 | (15.1) | (78.6) | 15.8 | 77.9 | 19.1 | 74.6 | 18.0 | 75.7 | 20.0 | 73.7 |
| 4 | 84.0 | 87.1 | 16.0 | 68.0 | 16.1 | 67.9 | (9.6) | (74.4) | 12.6 | 71.4 | 15.1 | 68.9 |
| 5 | 76.8 | 78.6 | 12.8 | 64.0 | (11.0) | (65.8) | 11.6 | 65.2 | 11.9 | 64.9 | 11.6 | 65.2 |
| 6 | 62.7 | 64.7 | 13.6 | 49.1 | (10.0) | (52.7) | 11.0 | 51.7 | 10.8 | 51.9 | 10.1 | 52.6 |
| 7 | 62.0 | 64.6 | 14.8 | 47.2 | 12.1 | 49.9 | 9.5 | 52.5 | (9.0) | (53.0) | 12.2 | 49.8 |
| 8 | 61.3 | 63.8 | 7.2 | 54.1 | 3.9 | 57.4 | 3.1 | 58.2 | (2.0) | (59.3) | 4.1 | 57.2 |
| 9 | 58.4 | 60.1 | 8.0 | 50.4 | 6.0 | 52.4 | 5.0 | 53.4 | (4.1) | (54.3) | 6.3 | 52.1 |
| 10 | 57.6 | 58.2 | 13.1 | 44.5 | 11.9 | 45.7 | (9.1) | (48.5) | (9.1) | (48.5) | 11.4 | 46.2 |
| 11 | 46.5 | 48.4 | 11.8 | 34.7 | 10.2 | 36.3 | 9.8 | 36.7 | 9.3 | 37.2 | (9.1) | (37.4) |
| 12 | 46.0 | 48.6 | 6.3 | 39.7 | 5.1 | 40.9 | 4.2 | 41.8 | (3.0) | (43.0) | 4.5 | 41.5 |
| 13 | 43.9 | 45.8 | 5.1 | 38.8 | 4.2 | 39.7 | 3.8 | 40.1 | (3.4) | (40.5) | 3.8 | 40.1 |
| 14 | 44.2 | 46.6 | 8.6 | 35.6 | 8.1 | 36.1 | (6.1) | (38.1) | 7.3 | 36.9 | 7.0 | 37.2 |
| 15 | 44.1 | 46.2 | 12.4 | 31.7 | 10.8 | 33.3 | (9.3) | (34.8) | 9.6 | 34.5 | 10.6 | 33.5 |
| 16 | 37.8 | 39.6 | 11.7 | 26.1 | 10.1 | 27.7 | 11.2 | 26.6 | 10.0 | 27.8 | (9.1) | (28.7) |
| 17 | 35.6 | 37.0 | 10.8 | 24.8 | 9.8 | 25.8 | 9.3 | 26.3 | 9.2 | 26.4 | (9.0) | (26.6) |
| 18 | 29.8 | 32.1 | 11.9 | 17.9 | 10.6 | 19.2 | 10.1 | 19.7 | 9.5 | 20.3 | (8.6) | (21.2) |
| 19 | 29.1 | 31.6 | 11.8 | 17.3 | 10.8 | 18.3 | 11.8 | 17.3 | 11.0 | 18.1 | (10.2) | (18.9) |
| 20 | 33.0 | 35.4 | 18.6 | 14.4 | 17.2 | 15.8 | 13.6 | 19.4 | (12.5) | (20.5) | 14.1 | 18.9 |
| 21 | 49.0 | 51.4 | 6.0 | 43.0 | 6.1 | 42.9 | 3.8 | 45.2 | (0.0) | (49.0) | 4.0 | 45.0 |
| 22 | 52.5 | 55.0 | 6.1 | 46.4 | 5.6 | 46.9 | 2.3 | 50.2 | (1.5) | (51.0) | 4.0 | 48.5 |
| 23 | 50.5 | 52.6 | 7.4 | 43.1 | 7.8 | 42.7 | 5.8 | 44.7 | (5.5) | (45.0) | 6.1 | 44.4 |

(5)

(10)

(5)

(2)

(2)

or the month in which water-table levels are generally high in this area. The data shown for August will be used in this example as it represents the most severe high water-table condition that occurred during the crop season.

Figure 4-17 is the same base map as shown in Figure 4-16 with some ground-water information added. The locations of the 23 observation wells are shown by small circles with the well numbers indicated by the figures within the circles. The elevation of the water table in each well for August (Column 11, Table 4-3) has been shown by the figures adjacent to each well.(Figure 4-17). Using these data and interpolating between wells, the ground-water contours have been drawn. These are the dashed lines shown, and have been drawn on a 5-foot-vertical interval to correspond in interval with the surface contours.

The ground-water contours show the configuration of the water-table surface in the same way that surface contours show the configuration of the land surface.

The direction of ground-water flow can be determined from ground-water contour maps as it is in the direction of maximum slope or hydraulic gradient of the water table. From inspection of the map, Figure 4-17, it is obvious that the ground-water flow is generally to the south with minor variations in localized areas. The arrows on the map indicate this directional flow. From this map it is also possible to determine the slope of the ground-water surface or the hydraulic gradient. In this example the average distance between 5-foot contours is about 500 feet. Therefore, the hydraulic gradient is about 1 percent.

Figure 4-18 uses the same base map as Figures 4-16 and 4-17 and shows information on the depth to ground water. The elevation of the water table at each well has been deleted and in its place the minimum depth to the water table (in parentheses in Table 4-3) has been plotted at the location of each well. With this information plotted on the map, it is possible to delineate areas having a similar depth to water table. For this example areas having water-table levels within the range 0 to 2 feet, 2 to 5 feet, and 5 to 8 feet have been delineated as shown by the dot and dash lines on Figure 4-18. In this example it was assumed that a water-table level 8 feet or deeper was not significant in drainage. It will be noted that the areas having the water table 8 feet or deeper are marked "8+ feet."

The data used in developing the "depth to water" feature on the working map include observation well readings for several months covering the entire period of record. The data used in developing the ground-water contours were taken from one set of observation well readings for August. For this reason the depth to water as shown gives a picture of the most severe water-table condition at each well during the entire period of record. Ground-water contours must always be drawn from water-table measurements of the same date.

Figure 4-19 is the completed working map showing all of the features developed progressively by the previous maps. A "depth to water" legend has been added to delineate areas with different water-table levels. The information given on a working map such as this, plus data from subsurface borings, is generally adequate for planning a subsurface drainage system. In this particular example, the working map developed shows the following:

1. The direction of ground-water flow is generally from north to south with some minor variations.

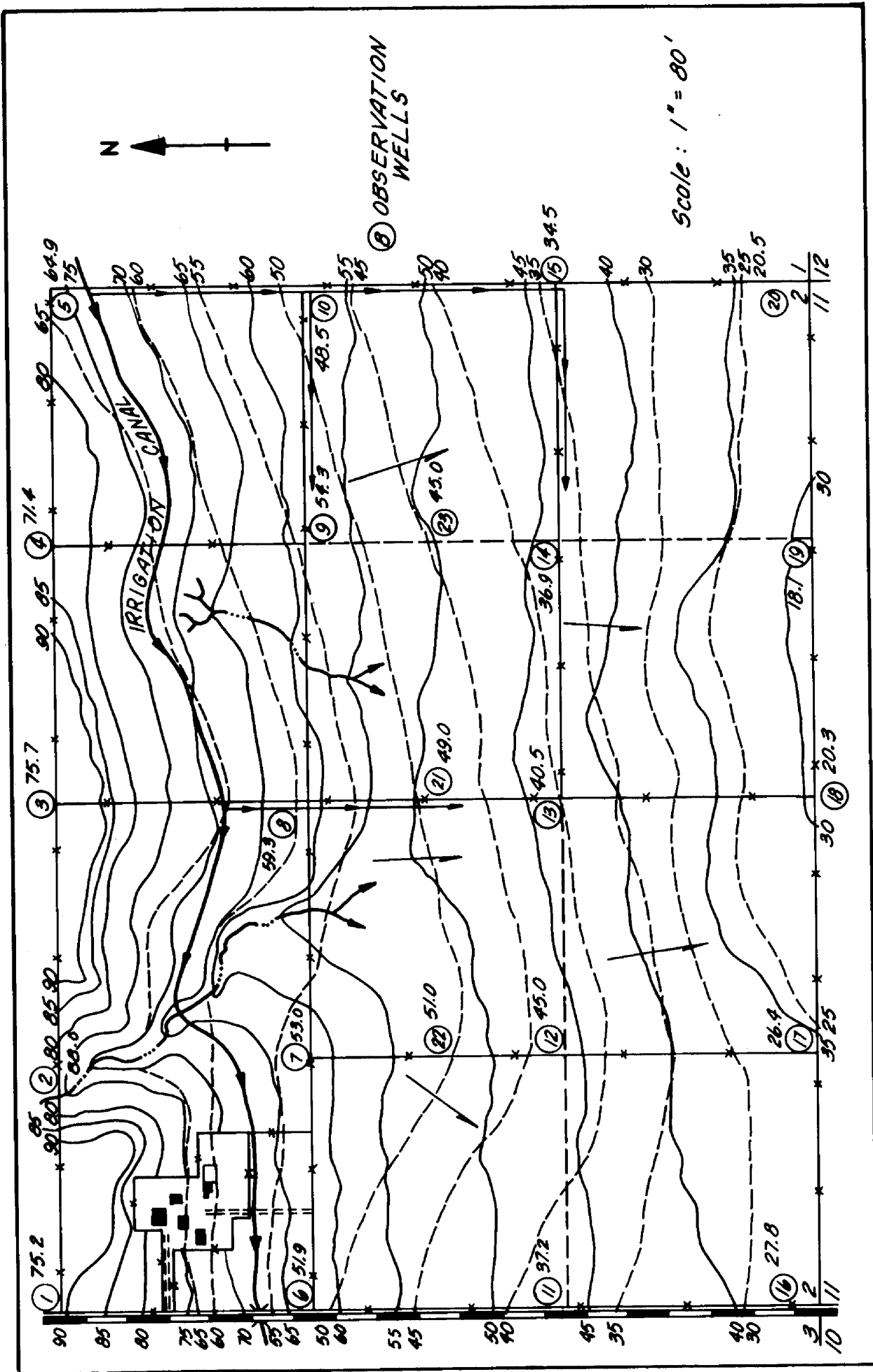

Figure 4-17, Working map--ground-water contours

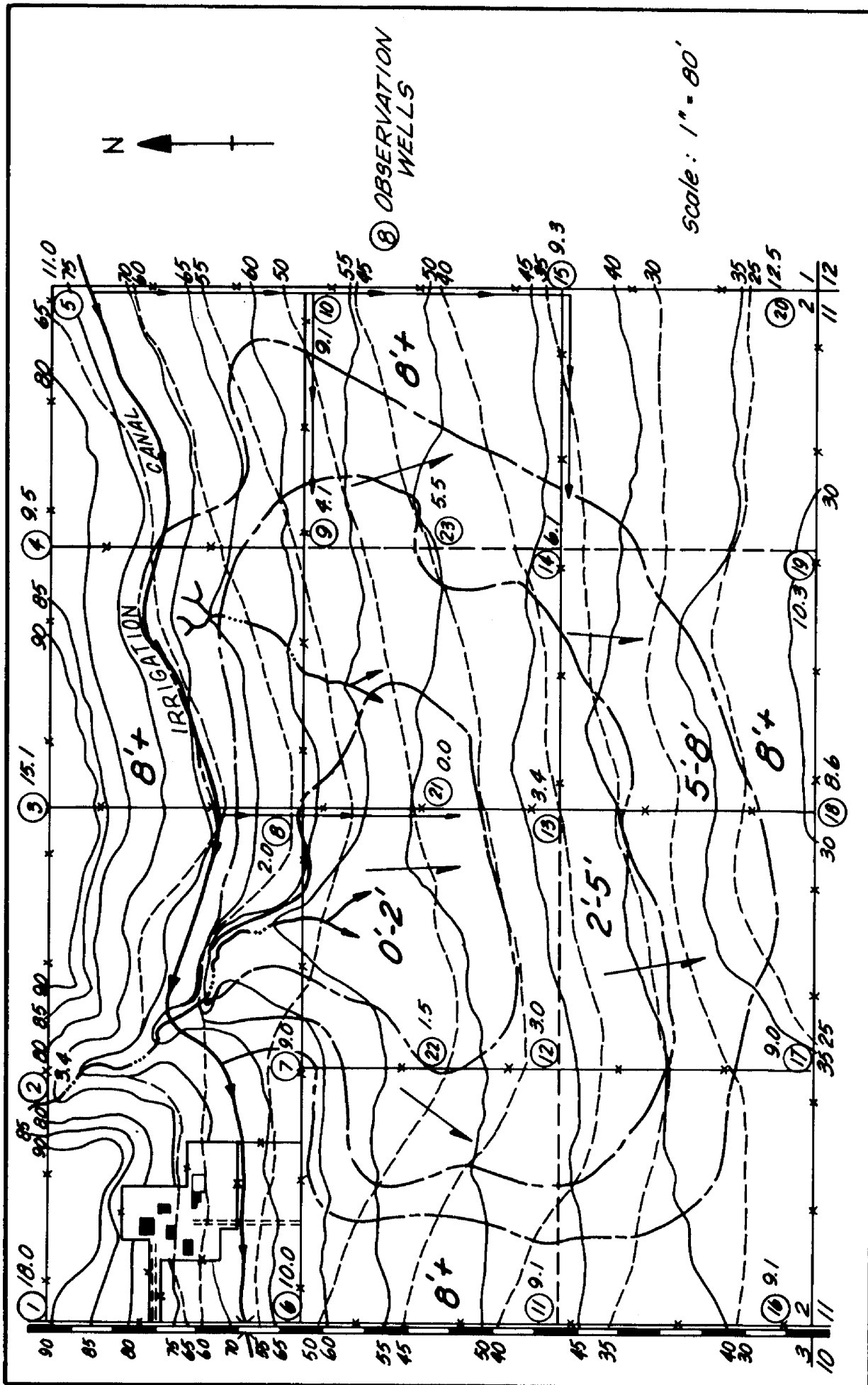

Figure 4-18, Working map--depth to ground water

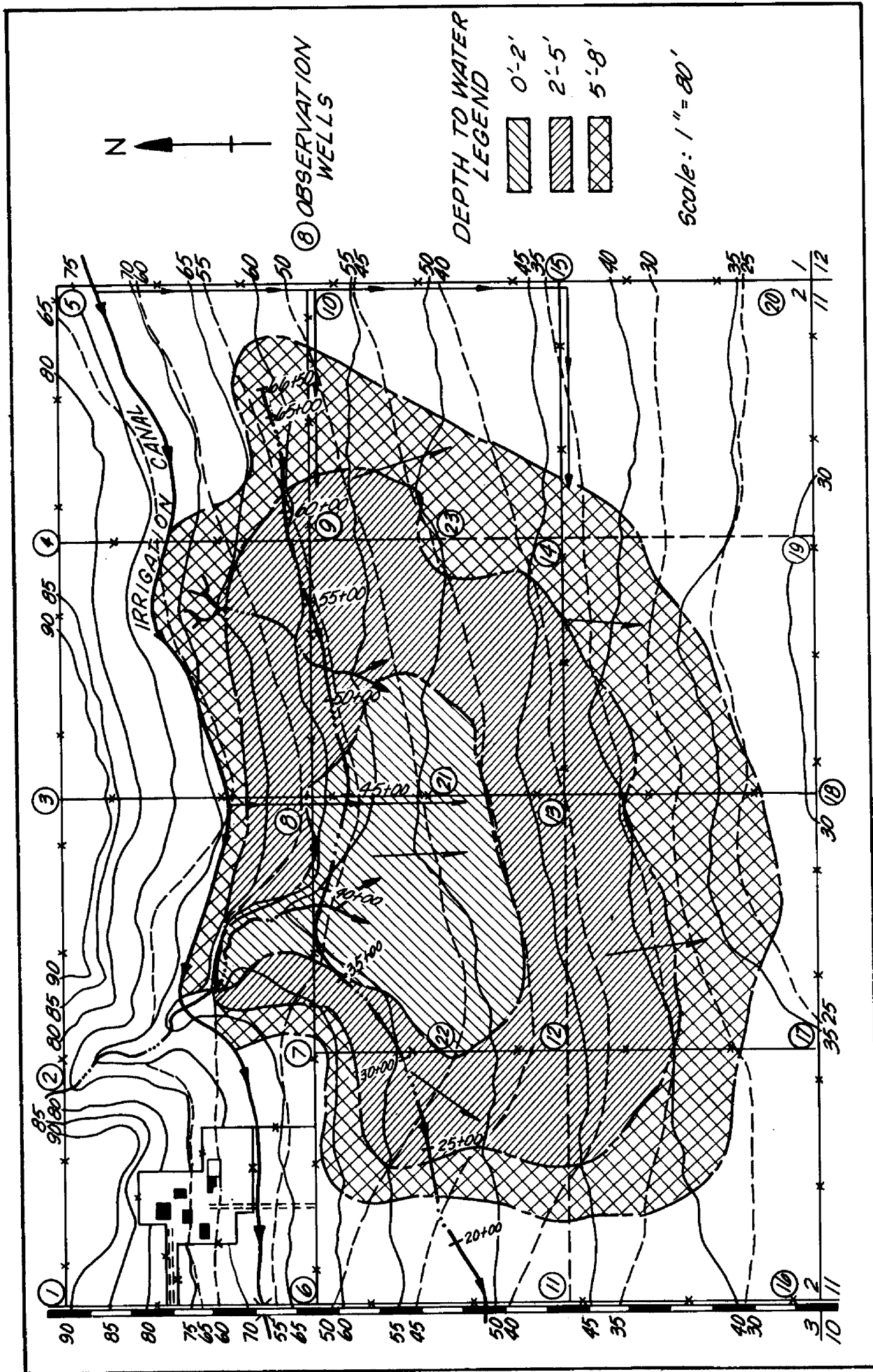

Figure 4-19, Working map--completed

2. The average slope of the water table or hydraulic gradient is about 1 percent, which is rather steep, indicating strong ground-water flow, the quantity depending on the permeability of the soil strata and hydraulic gradient.
3. The location and extent of the high water-table area.
4. The relative degree of wetness within the wet areas as shown by the legend.
5. The configuration of the water-table surface within the wet area and immediately adjacent area.

The completed working map in Figure 4-19 shows some of the more commonly used graphic representations of information necessary for planning a drainage system except for information on subsoil and substratum material. Usually it is not necessary to show this information on the working map; however, it can be shown if it is needed. When logs of subsurface borings are prepared, it is easy to make reference to conditions at the location of each boring. At this stage of development of the working map the general type of drain or drains to be installed can be determined and the locations fixed within approximate limits. Referring to Figure 4-19, it is obvious from the location of the wet area and the direction of ground-water flow that the source of excess ground water is either from canal seepage or from irrigation losses. For this example, it will be assumed that canal seepage has been investigated and found to be a factor in contributing to the high water table, but not sufficient in itself to have caused this wet condition. The source of water is a combination of canal seepage and general losses from irrigation. Under this set of conditions and with a water-table gradient of about 1 percent, an interception-type drain would be recommended. The drain should be located about perpendicular to the direction of ground-water flow and in a position near the upper edge of the wet area. In many locations the interception drain will intercept the water causing a high water table below it and will have a drawdown effect above it sufficient to lower the water table and relieve that area. The combination of relatively high permeability and steep gradient indicates that a large ground-water flow is involved. The proper location for a drain is shown in Figure 4-19. For this example, it is assumed that subsoil and substratum permeabilities are satisfactory for a drain at this location and that an adequate outlet is available for the drain.

Figure 4-20 shows a cross-sectional profile (north and south) from well no. 3 through well no. 18. This illustrates the points discussed before. It is often desirable to examine certain conditions by drawing cross-sectional profiles such as the one in Figure 4-20 which shows the relative position of the ground surface and the water-table level. When subsoil materials are stratified or when there is a definite aquifer present, the location of the top and bottom horizon should be plotted on the profile. This enables a better location of the drain to be made relative to the position of the stratified layer. Often it is necessary to shift the drain location upslope or downslope to get the best position relative to subsurface materials.

This example illustrates conditions where an interception-type drain would be employed. A similar method of compiling and analyzing data would apply under conditions where a relief drainage system would be used. In either case the drainage system recommended might include open ditches or buried drains. The purpose of this example is to illustrate a method for assembling the data obtained from various surveys, studies, and investigations. This method, or

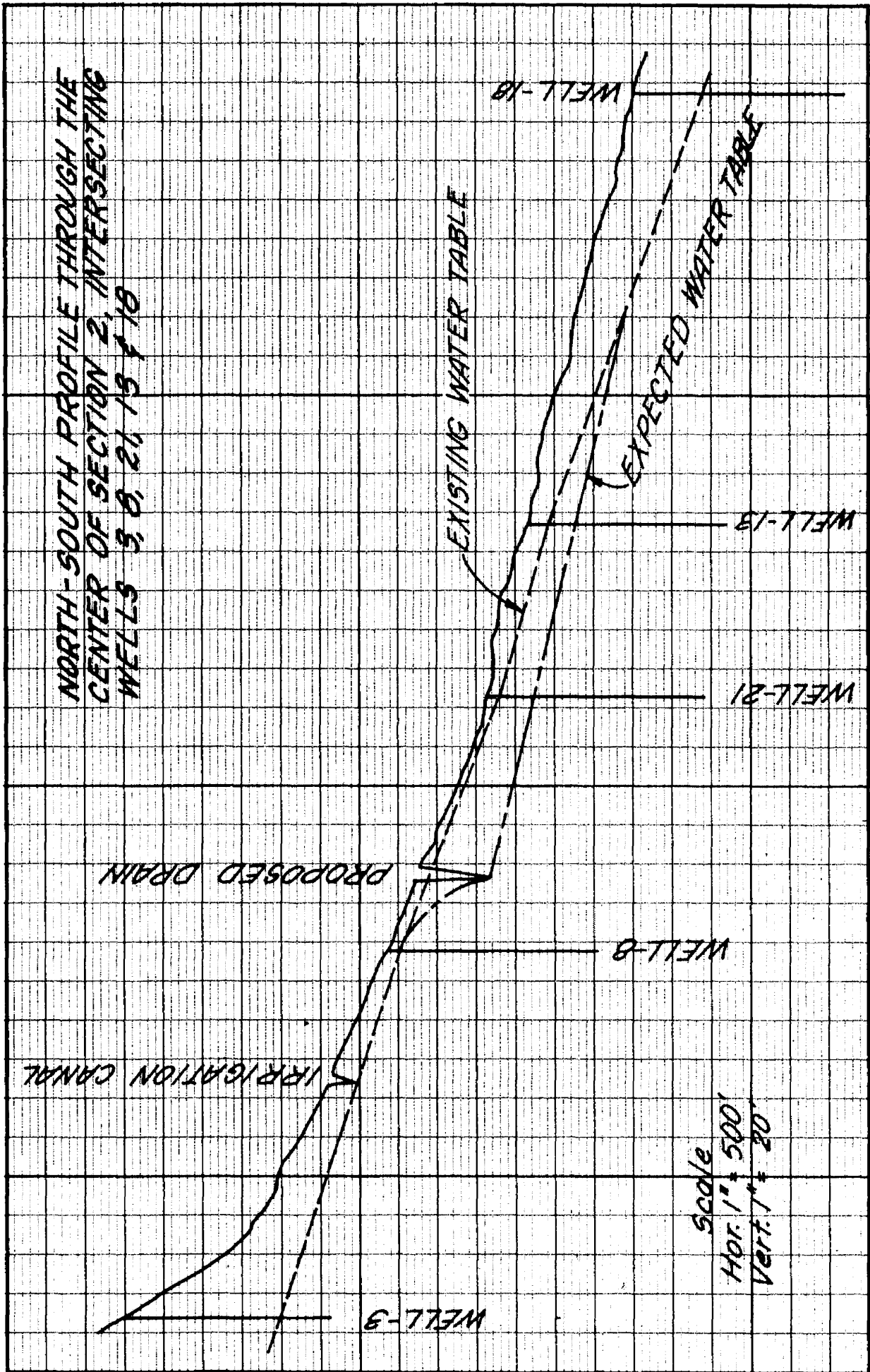

Figure 4-20, Profile--Figure 4-19

some similar method of analyzing available data, is necessary before actual design work on the individual drainage system and appurtenant structures can be started.

Design of Subsurface Drains

Drainage coefficients

The drainage coefficient is that rate of water removal, used in drainage design, to obtain the desired protection of crops from excess surface and subsurface water. The drainage coefficient can be expressed in a number of units, including depth of water in inches to be removed in a specific time, flow rate per unit of area, and in terms of flow rate per unit of area, which rate varies with the size of the area. The last is used most frequently for surface drainage design and the first most frequently for subsurface design.

Humid areas

In the humid areas it is common practice to express the drainage coefficient for subsurface drainage in units of inches depth removal in 24 hours. This coefficient is closely related to the climate, and infiltration characteristics of the soils; therefore, within areas of similar climatic and soils characteristics there is similarity in drainage coefficients. For this reason it is possible to establish ranges of drainage coefficients that are applicable to large areas. The general guides given in the following table are based on many years of drainage experience and list ranges of coefficients applicable in humid areas.

1. When the land to be drained has a separate surface drainage system, drainage coefficients given in Table 4-4 have been used in the northern humid area. Data on soil permeability and climate should be considered in developing coefficients for a specific area.

Table 4-4, Drainage coefficients without surface-water inlets

| Soil | Inches to be removed in 24 hours | |
|---------|----------------------------------|---------------|
| | Field Crops | Truck Crops |
| | <u>Inches</u> | <u>Inches</u> |
| Mineral | 3/8 - 1/2 | 1/2 - 3/4 |
| Organic | 1/2 - 3/4 | 3/4 - 1-1/2 |

2. Where it is necessary to admit surface water to drains through surface inlets, an adjustment in the required capacity of the drain must be made. Runoff from an area served by a surface-water inlet takes place soon after precipitation and enters the drain ahead of the ground water. In short lines or small drainage systems where only one or two inlets are installed the size of the drain may not need to be increased. As drainage systems become larger or the inlets more numerous, an adjustment to the drainage coefficient should be made. The timing of the surface-water flow in relation to the entrance of ground water into the drain should be the basis of increasing the coefficient over those shown in Table 4-4.
3. A higher coefficient than those given in Table 4-4 may be necessary to hold crop damage to a minimum. The great variation in drainage requirements indicates the necessity for careful observations and analyses in establishing coefficients.

Arid areas

In arid areas, drainage coefficients applicable to local irrigated areas are highly variable and depend on the amount of irrigation water applied, the method of irrigation, the leaching requirement, and the characteristics of the soil and subsurface materials. It is necessary to develop drainage coefficients for specific areas based on evaluation of the above factors and experience in the area. From actual surveys (6) made on one million acres of irrigated land, it is known that the yield from subsurface drains may range from 0.10 to 40.0 cfs per mile of drain. Recent studies made on eight individual farm projects indicate that the drain yields ranged from 0.13 to 3.90 cfs per mile of drain. Other measurements have been made which indicate a wide variation. With such a wide variation in yield, coefficients must be based upon good investigations and local experience within a given area.

In irrigated areas where there is insufficient experience to establish acceptable drainage coefficients for general use, they can be computed from the following formula based on irrigation application:

$$q = \frac{\left(\frac{P + C}{100}\right) i}{24F} \quad (\text{Eq. 4-2})$$

where:

q = drainage coefficient--inches per hour

P = deep percolation from irrigation including leaching requirement--percent (based on consumptive-use studies)

C = field canal losses--percent

i = irrigation application--inches

F = frequency of irrigation--days

The following example illustrates the use of this formula:

1. From consumptive-use studies, deep percolation from irrigation is 20 percent.
2. Field canal losses are estimated to be 8 percent of the water applied.
3. The operator applies a 6-inch irrigation each 14 days.

$$q = \frac{\left(\frac{20 + 8}{100}\right) 6}{(24)(14)} = 0.005 \text{ in./hr.}$$

Figure 4-21 is a chart for the graphical solution of this equation. The previous example can be solved by the chart as follows:

Step 1. Add the percentage deep percolation loss to the percentage canal loss (P + C) and find this value on the left hand vertical scale.

$$P + C = 20 + 8 = 28$$

Step 2. From this point follow horizontally to the right to intercept the irrigation application (i) curve.

$$i = 6$$

Step 3. Follow vertically up or down as the case may be to intercept the application frequency (F) curve.

$$F = 14$$

Step 4. Follow horizontally to the right hand vertical scale and read (q) the drainage coefficient.

$$q = 0.005$$

From information and data currently available, it is known that drainage coefficients applicable to irrigated land range from about 0.005 inch per hour to 0.01 inch per hour. Drainage coefficients for irrigated areas are generally smaller than for nonirrigated areas even though the total amount of water applied through irrigation may be the same as precipitation in the nonirrigated areas. The reason for this is that irrigation applications are made at regular intervals and in like amounts, which tends to support a steady and uniform ground-water return flow to the drains. In nonirrigated areas the frequency and intensity of precipitation is highly variable which tends to make the return flow to drains variable with peak flows occurring in the ground-water regime.

In many irrigated areas, drainage systems are planned on a project basis and may encompass entire corporate irrigation enterprises which may include a number of farms and ranches, containing several thousand acres of land needing drainage. In planning drainage systems of this magnitude it is common practice to plan a project-type system of disposal ditches or drains to serve each farm or ranch in the group enterprise.

The disposal system is financed and constructed through the group enterprise and the individual farm or ranch collection systems are financed and constructed by the individual landowner.

In large developments of the type discussed above there are conditions and situations which warrant a reevaluation of the drainage coefficient applicable to design of the disposal system. In general, the design capacity for the disposal system can be based on lower drainage coefficients than those generally applied to the collection system. Experience based on measurements of discharge from scattered projects indicate that the return flow from large irrigated tracts is in the general range of 2 to 4 cfs per square mile. This is about 30 percent less than the return flow directly to the collection system and is due to a number of intangible factors such as: ground-water export through deep percolation to regional aquifers; consumptive use by trees and phreatophytes within the general project area; pumping of ground water for nonagricultural uses; land temporarily removed from irrigation because of economic or cultural management practices, etc., the total of which has a significant effect on regional return flows. Drainage coefficients recommended for drainage of specific soils in a particular area may be found in local drainage guides if available. These are based on local investigations and experience.

GRAPHICAL SOLUTION—DRAINAGE COEFFICIENT FOR IRRIGATED AREAS

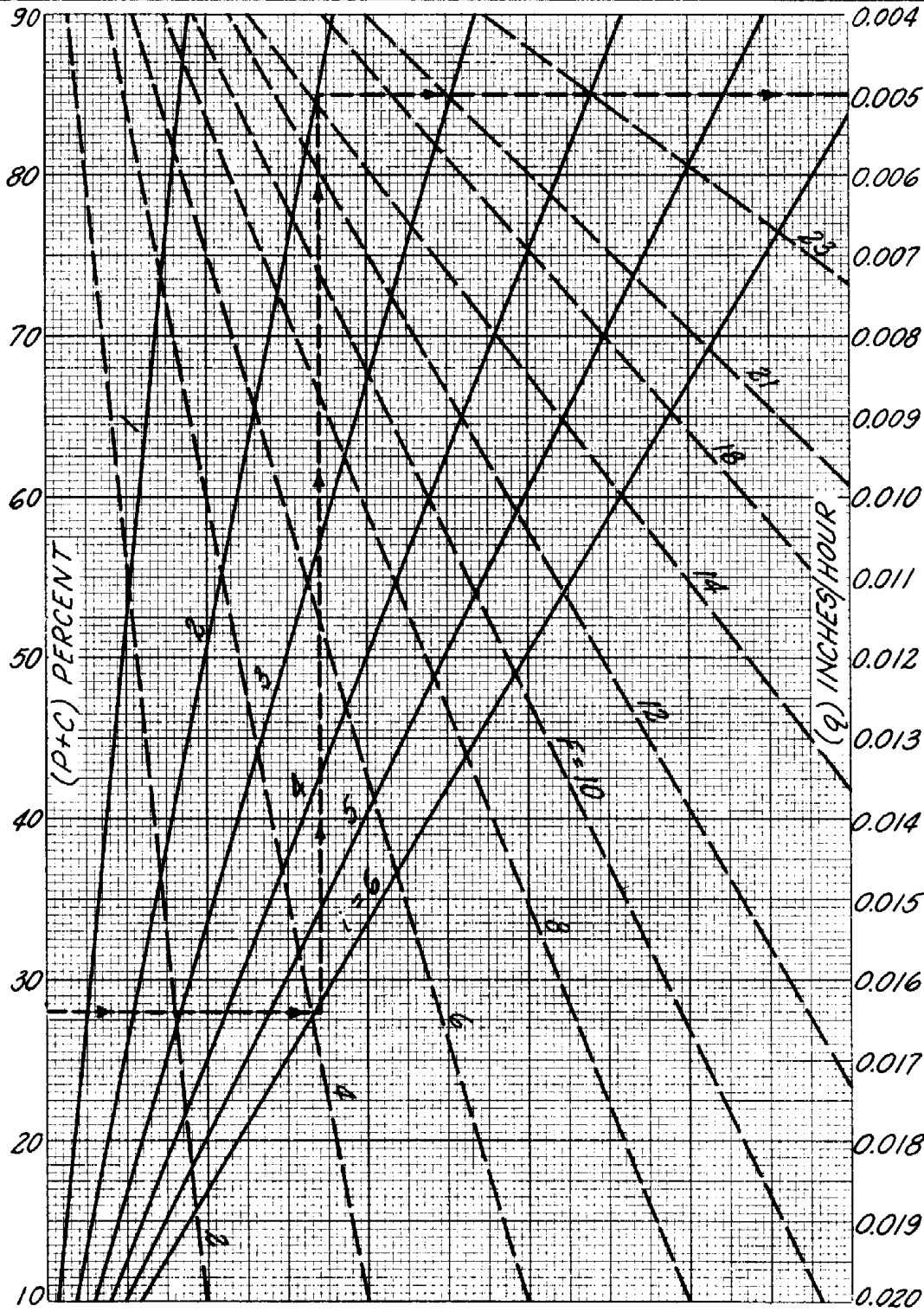

REFERENCE: This chart was developed by William F. Long.

U. S. DEPARTMENT OF AGRICULTURE
 SOIL CONSERVATION SERVICE
 ENGINEERING DIVISION - DRAINAGE SECTION

STANDARD DWG. NO.
 ES - 715
 SHEET 1 OF 1
 DATE 8-3-70

Figure 4-21, Graphical solution - drainage coefficient

Design capacityRelief drains

In the case of parallel relief drains the area served by the drain is equal to the spacing times the length of the drain plus one-half the spacing. The discharge can be expressed by the following formula:

$$Q_r = \frac{q S(L + S/2)}{43,200} \quad (\text{Eq. 4-3})$$

where:

Q_r = relief drain discharge--cfs

q = drainage coefficient--in./hr.

S = drain spacing--feet

L = drain length--feet

Reference is made to Figure 4-22, which shows a parallel relief drain system. The system contains eight lateral drains and one main drain to the outlet. The shaded area indicates the area drained by one of the lateral drains. The following example illustrates the use of Equation 4-3 in computing the design capacity for one lateral in the system shown.

Example: (Refer to symbols on Figure 4-22)

1. drain spacing--300 feet
2. drain length--1,100 feet
3. drainage coefficient--0.008 in./hr.

$$Q_r = \frac{(0.008)(300)(1,100 + 150)}{43,200} = 0.069$$

This is the design discharge of the lateral at its point of confluence with the main drain. The drainage system illustrated contains eight laterals of the same length and with equal spacing; therefore, the design capacity of the main drain would be $(8)(0.069) = 0.552$ cfs plus the direct accretion to the main drain.

The main which is 2,250 feet in length is effective on one side only and therefore would collect $\frac{0.5(2,250 + 150)}{1,100 + 150} \times 0.069 = 0.066$ cfs and the discharge of the main, at the point where it leaves the field would be $(0.56) + (0.06) = 0.62$ cfs. Each of the lateral drains in the above example has a design discharge that varies uniformly from 0.07 cfs at its outlet to zero at its terminus. The design discharge of the main varies uniformly from 0.62 cfs to 0.07 cfs at its confluence with the last lateral in the system. This immediately suggests that variable size drains might be used in the system and this point will be discussed in a later section of this chapter.

Figure 4-23 is a chart prepared for the graphical solution of the discharge equation (Eq. 4-3).

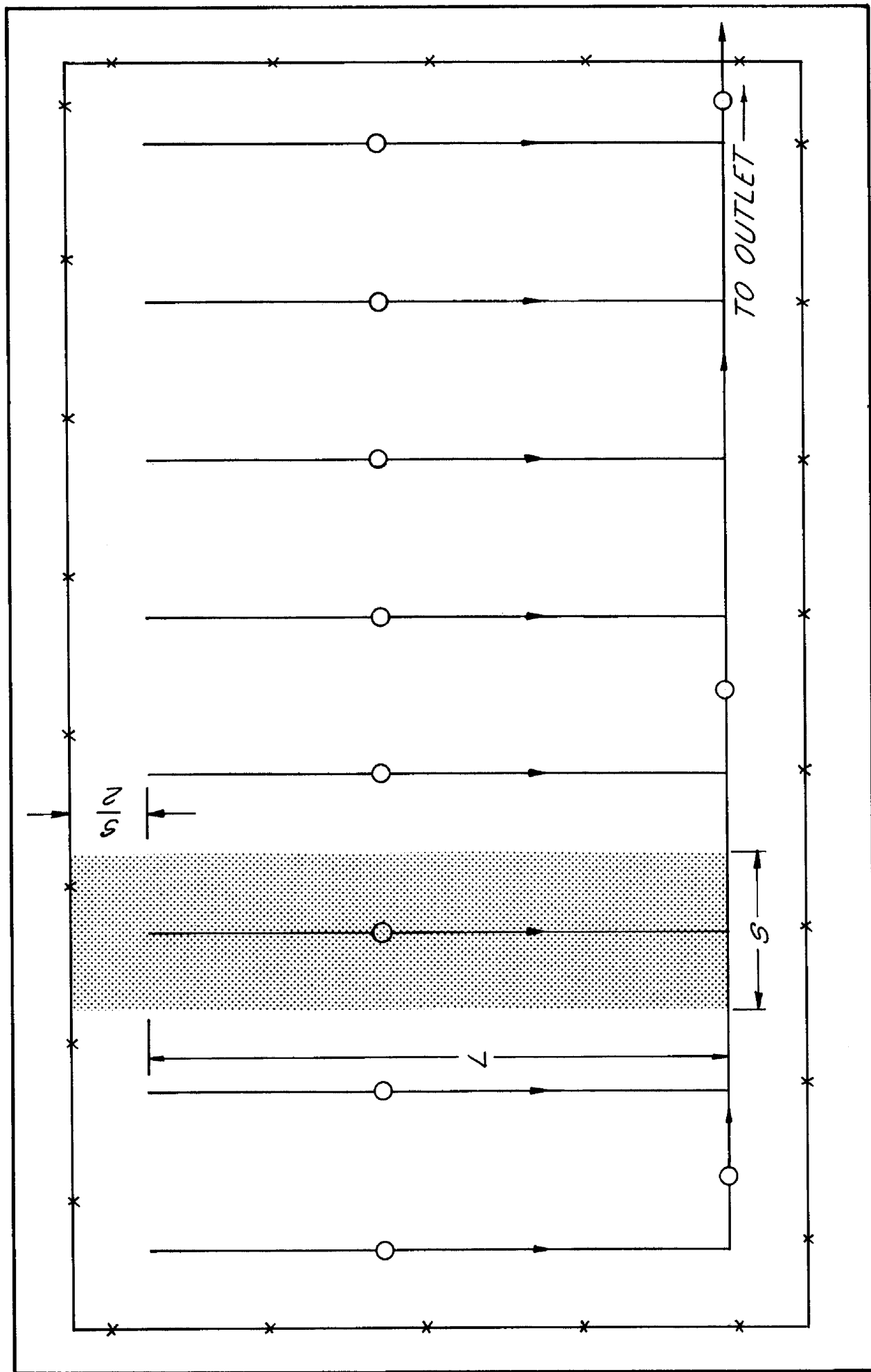

Figure 4-22, Sketch of relief drain system showing symbols in equation 4-3

Example:

1. drain spacing--200 feet
2. drainage coefficient--0.02 in./hr.
3. drain length --3,000 feet

Referring to Figure 4-23, find spacing of 200 feet on the left ordinate; follow horizontally to the right to intersect the drainage coefficient curve for value of 0.02; from this point follow vertically to intersect the drain length curve for the value of 3,000; from this point follow horizontally to the right ordinate to read value of design discharge equal to 0.30 cfs.

Interception drains

The capacity of interception drains must be equal to the ground-water flow intercepted. The rate of flow is in accord with the Darcy Law, which states that the velocity of flow of water through porous material is proportional to the hydraulic conductivity and hydraulic gradient. The equation may be stated:

$$v = Ki \quad (\text{Eq. 4-4})$$

where:

v = velocity of flow through the porous medium

K = the hydraulic conductivity

i = the hydraulic gradient (undisturbed state)

The flow of water intercepted (Q) is equal to the average velocity multiplied by the cross-sectional area (A) of the aquifer intersected below the water table. Therefore, the equation for flow through a porous material is as follows:

$$Q = KiA \quad (\text{Eq. 4-5})$$

Applying this to an interception drain, the cross-sectional area intersected is equal to the effective depth of the drain (vertical distance from the bottom of the drain to the water-table level) times the length of the drain. Stated in mathematical form it is:

$$A = d_e L \quad (\text{Eq. 4-6})$$

where:

A = cross-sectional area intersected--sq. ft.

d_e = average effective depth of the drain--ft.

L = length of the drain--ft.

Combining equations 4-5 and 4-6 and correcting for units, the equation for the design discharge of an interception drain is:

GRAPHICAL SOLUTION - DRAIN DESIGN DISCHARGE

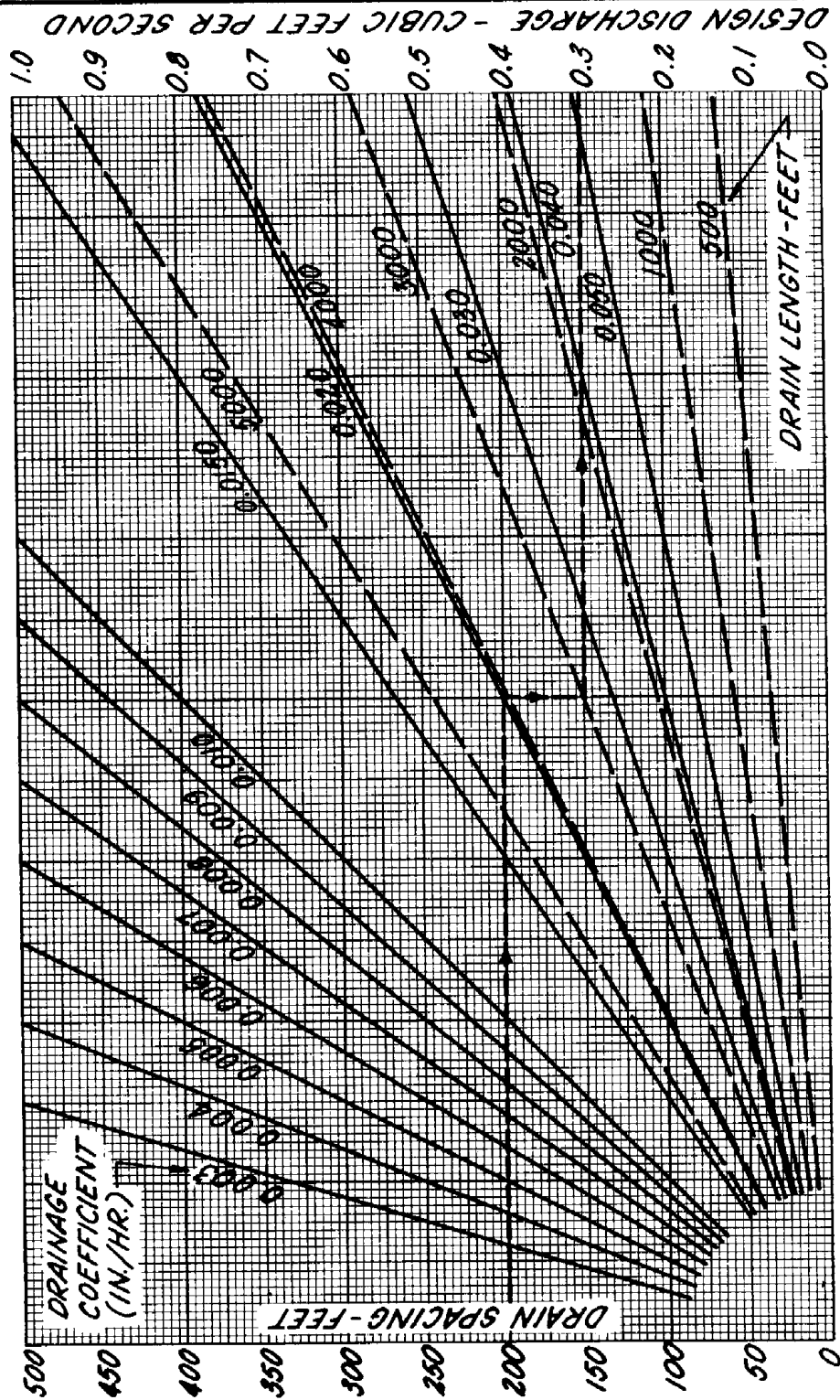

Note: This chart is for a single relief drain in a parallel system

REFERENCE: This chart was developed by William F. Long.

U. S. DEPARTMENT OF AGRICULTURE
 SOIL CONSERVATION SERVICE
 ENGINEERING DIVISION - DRAINAGE SECTION

STANDARD DWG. NO.
 ES - 716
 SHEET 1 OF 1
 DATE 8-3-70

Figure 4-23, Graphical solution, drain design discharge

$$Q_i = \frac{K i d_e L}{43,200} \quad (\text{Eq. 4-7})$$

where:

Q_i = design discharge of an interception drain--cfs

K = hydraulic conductivity--in./hr.

i = hydraulic gradient of the undisturbed water table--feet per foot

d_e = average effective drain depth--feet

L = length of drain--feet

The above equation has several limitations when applied in actual practice. The Darcy Law, on which it is based, assumes a homogeneous soil profile, a uniform hydraulic conductivity throughout the soil profile and an accurate determination of the cross-sectional area. The first two assumptions stipulate conditions that are rarely, if ever, found in nature; however, some site conditions may approach these. Use of this formula must be reserved for conditions that approach these idealistic site conditions.

The following is an example illustrating the use of Equation 4-7.

1. The average hydraulic conductivity computed from values measured at various points along the route of the interception drain is 10 in./hr.
2. The hydraulic gradient or slope of the original water-table surface is 0.05 feet per foot.
3. The effective depth of the drain is 7.0 feet.
4. The length of the drain is 4,500 feet.

$$Q_i = \frac{10(0.05)(7)(4,500)}{43,200} = 0.36 \text{ cfs}$$

In areas where use of the formula is not applicable and where there is no experience with interception drains, it is often desirable to construct a pilot ditch. By measuring the discharge from the pilot ditch an accurate discharge figure can be obtained to design the proper drain size. In some areas this two-step method is an accepted practice for installation of interception drains. The cost of installation is usually higher but due to better information on required capacity the correct size of drain can be determined. This may be substantially smaller than would be selected on the basis of less accurate information, and may result in more than enough saving to offset the cost of two-step construction.

Combination surface and subsurface drainage systems

It is common practice to install systems to serve both surface and subsurface drainage needs. In systems employing only open ditches, the ditches are made deep enough for subsurface drainage and surface water is admitted through drop structures of various types. In systems employing buried drains for subsurface drainage, the system includes land forming practices and field ditches for surface drainage and buried drains for subsurface drainage. The larger laterals and mains of the disposal system are open ditches. Surface water is routed to the open ditches where it is admitted to the system through drop

structures. It should not be admitted to buried drains as it carries debris which may plug the drain. In unusual situations where there is no alternative to admitting surface water to a buried drain, the line should be protected from debris and sediment as described later in this chapter.

The required capacity of dual-purpose ditches is the sum of the design discharge from subsurface drains and the design discharge from surface ditches. Surface water includes irrigation tail water, runoff from precipitation, and flooding that may occur in the event of the failure of irrigation canals serving the area. Under normal conditions the capacity of open ditches used in combination systems is more than adequate because of the depth required for subsurface drainage. However, the capacity should be checked.

Depth and spacing of drains

General

Considerable information and data have been collected and studied to develop criteria for computing the depth and spacing of relief-type drains. Conversely, very little has been done to develop technical criteria to compute the depth and spacing for interception-type drains. The design of interception drains is based largely on experience. It is possible to present some of the known and observed characteristics to serve as a guide to the designer.

Figures 4-24a and 24b are sketches to illustrate the change in configuration of the water table before and after the installation of a ditch or drain for relief drainage. Figure 4-24a shows an open relief ditch and Figure 4-24b shows a relief drain. Relief ditches and drains are located approximately parallel to the direction of ground-water flow or where the water table is relatively flat and will develop similar drawdown curves on either side of the ditch or drain. The new hydraulic gradient will be composed of two similar curves on either side of the drain. It follows that lowering of the water table on either side of the drain will be in the same amount at equal distances on either side of the drain. Relief drains are usually installed in series (parallel system) such that their areas of influence overlap and the new hydraulic gradient is a series of curves (ellipses) with the high point in the curves being at the midpoint between drains.

Figures 4-25a and 4-25b are sketches (exaggerated slope) to illustrate the change in configuration of the water table subsequent to installation of an interception ditch or drain. Figure 4-25a shows an interception ditch and 4-25b an interception drain. Interception ditches and drains "skim-off" or divert the upper portion of ground-water flow, and if fully effective, should lower the water table to near the level of the flow line in the drain.

Interception ditches and drains are effective for a considerable distance below or downslope from the ditch or drain but are less effective above or upslope from it. The new hydraulic gradient upslope from the interceptor is much steeper than that downslope. Under average field conditions it usually coincides with the original gradient at a point less than 300 feet above the interceptor, depending on the depth of the drain, etc. For this reason interception ditches and drains are located near the upper edge of the wet area to be protected.

In theory, if there were no accretion to ground water below the location of the interception drain it would be effective an infinite distance downslope. The new downslope hydraulic gradient would be parallel to the original

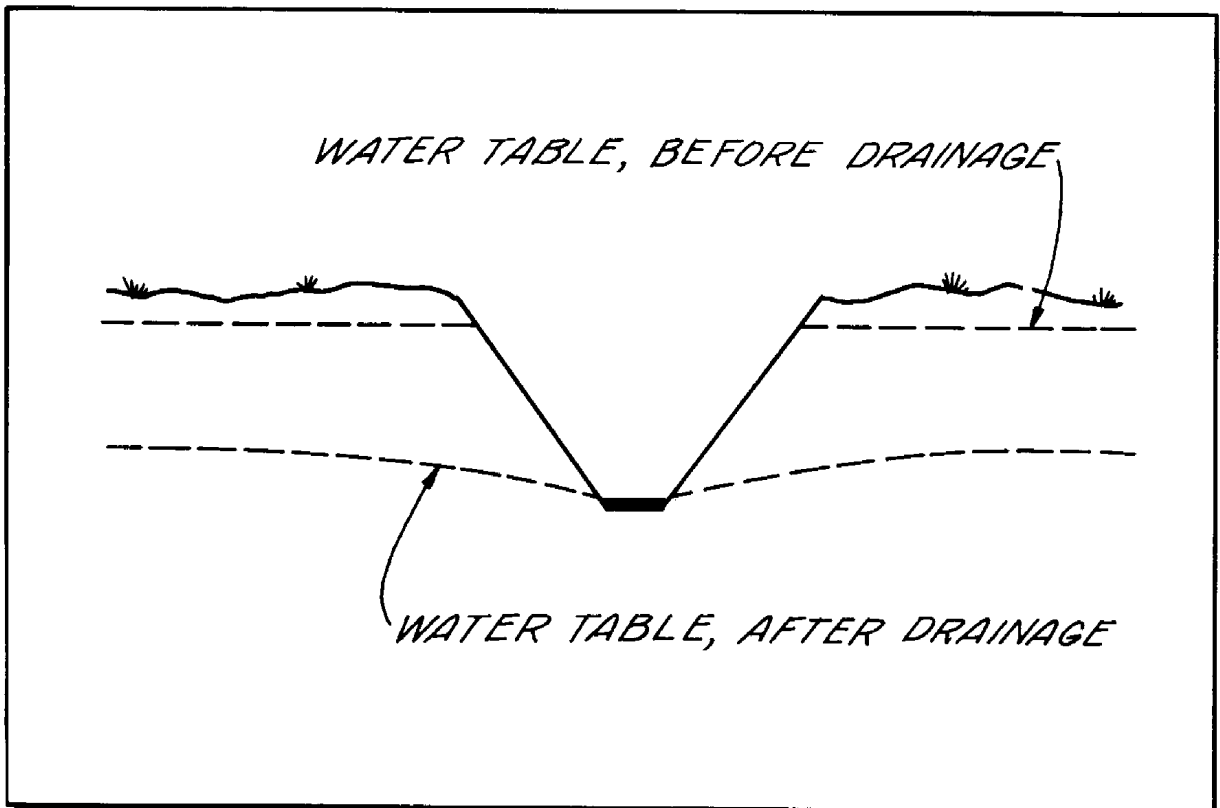

Figure 4-24a, Relief ditch

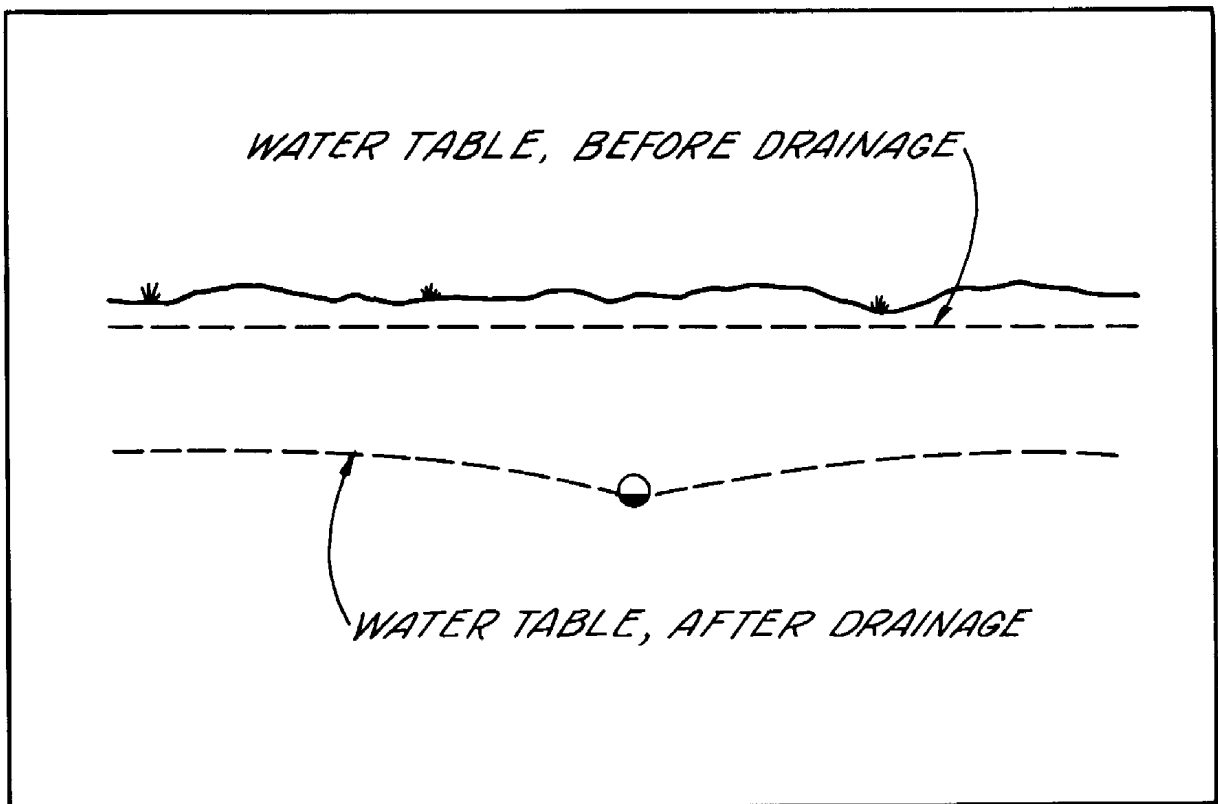

Figure 4-24b, Relief drain

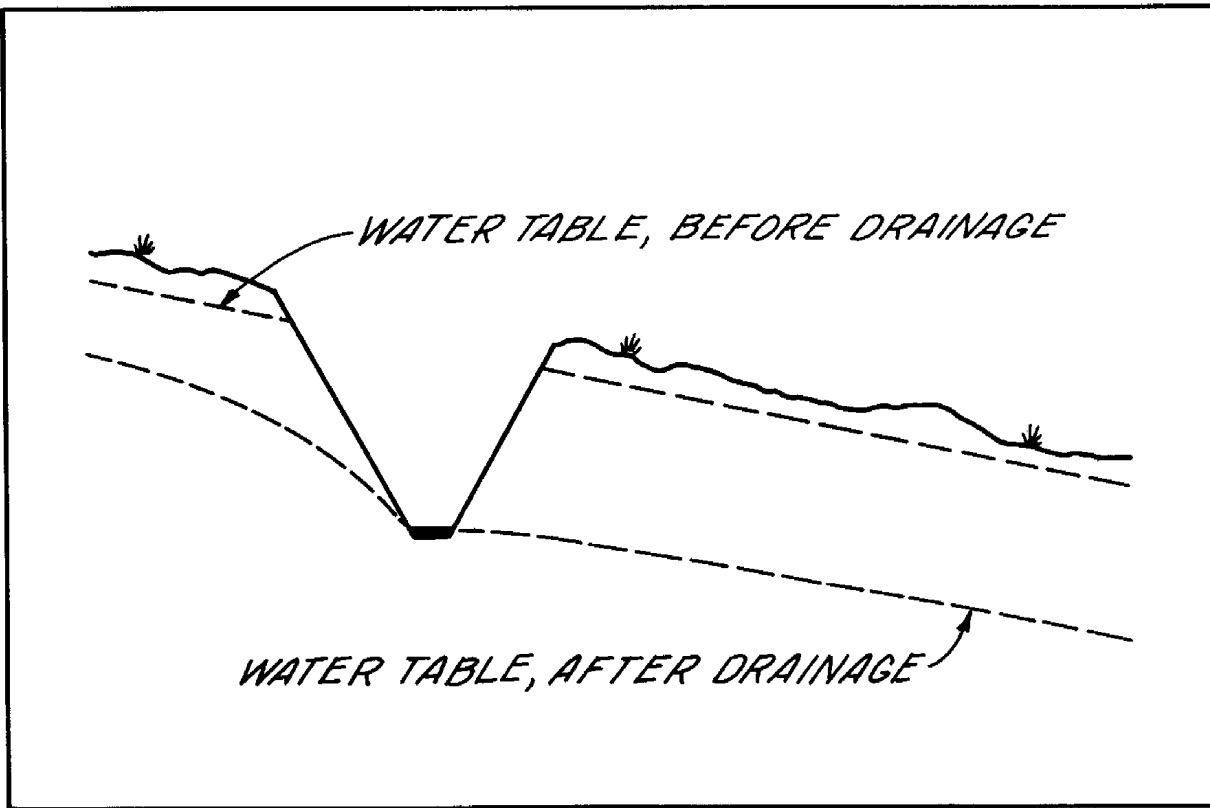

Figure 4-25a, Interception ditch

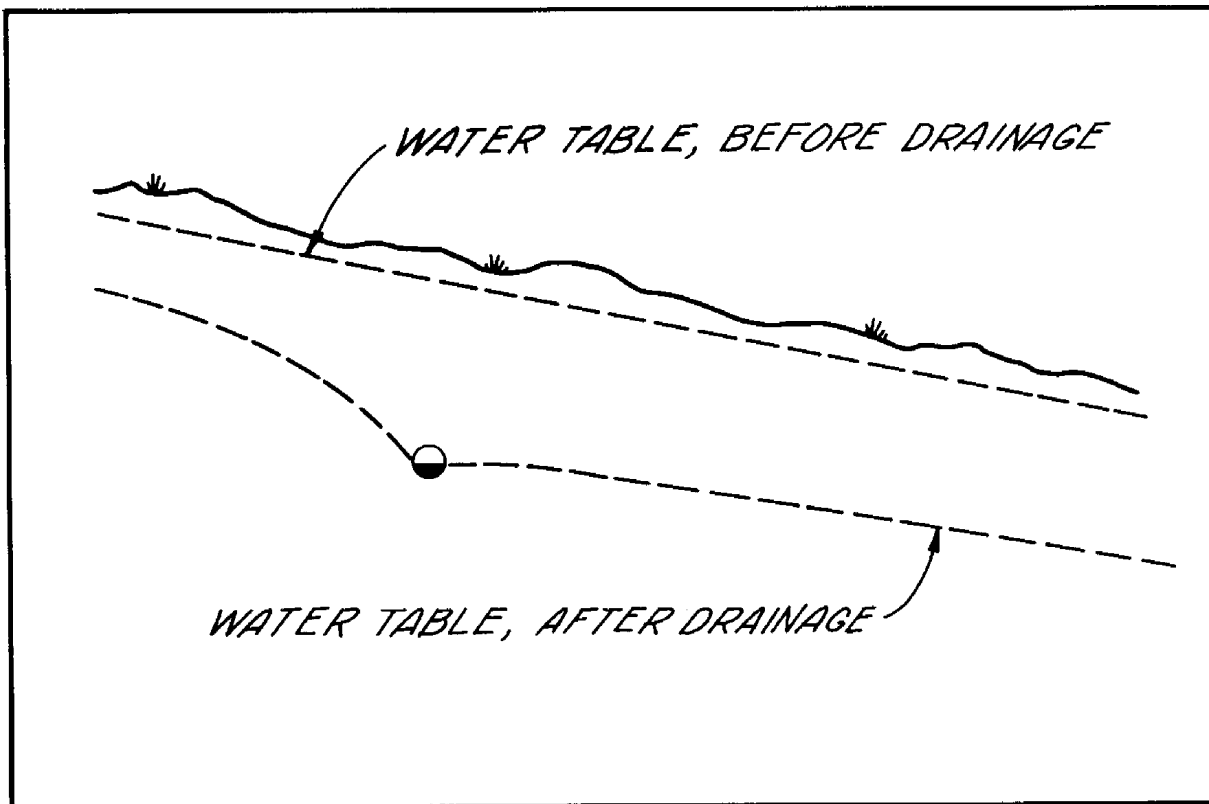

Figure 4-25b, Interception drain

(before drainage) and at a distance below it, equal to the effective depth of the interception drain. Under field conditions this never occurs as there is always accretion from irrigation or percolation from precipitation, and the new hydraulic grade line is a flat curve which is tangential to the original gradient at some point downslope from the drain. The slope of this downslope hydraulic grade line will vary with the amount of accretion from irrigation or precipitation as the case may be. The distance below an interception drain to which it will be effective in lowering the water table involves many factors, but is related primarily to accretions to ground water in the area immediately below the drain. Accretions include general irrigation losses, percolation from rainfall, leaching applications, capillary fringe flows above the phreatic line, and the "bridging-over flow" over the interception drain. These latter two are very difficult to evaluate. They may be significant for buried drains in steep areas but are not a problem in open ditches. Gravel envelopes and porous trench backfill will reduce these bypass flows. It is reasonable to assume that accretions to the downslope water table will be about the same in areas where irrigation methods, climatic conditions, slope and soil conditions are similar. It follows that the draw-down effect below interception ditches and drains where these conditions are similar, will be about the same.

Figure 4-26 is an isometric sketch showing both relief and interception drains, in situs, to illustrate their effect in altering the configuration of the water table. It will be noted that the hydraulic gradient for the undisturbed state (i), in Figure 4-26, has a positive value, perpendicular to the interception drain but is equal to zero perpendicular to the relief drains as shown. From this it is apparent that the slope of the original water-table surface (i) is a factor in the functioning of an interception drain but has no influence in the way a relief drain functions.

Theoretically, the proportional amount of ground water diverted or removed by the interception drain is the proportion of the depth of the drain to the total depth of the aquifer above the barrier (7). If the interception drain is placed on the barrier and has adequate capacity to collect and remove the ground water present (with no bridging-over effect) it will remove all of the flow from the aquifer.

A barrier is defined as a less permeable stratum, continuous over a major portion of the area to be drained, and of such thickness as to provide a positive deterrent to the downward percolation of ground water. The hydraulic conductivity of the barrier material must be less than 10 percent of that of the overlying material if it is to be considered as a barrier.

As previously stated, relief drains have a drawdown effect equidistant on either side of the drain. The drawdown curves that develop as a result of drainage, are described mathematically by the Modified Ellipse equation as given later in this chapter. This equation has a factor for the depth to the barrier which reduces the spacing as the depth to barrier is reduced.

From the above discussion on relief and interception drains, two significant points have been emphasized. First, the distance to which interception drains are effective in lowering the water table varies with the slope of the hydraulic grade line of the original water-table surface, but is not limited by the position of the barrier. Secondly, the distance to which relief drains are effective in lowering the water table varies with the position of the barrier, but is not influenced by the slope of the hydraulic grade line of the original water-table surface. These points suggest that relief drains may be

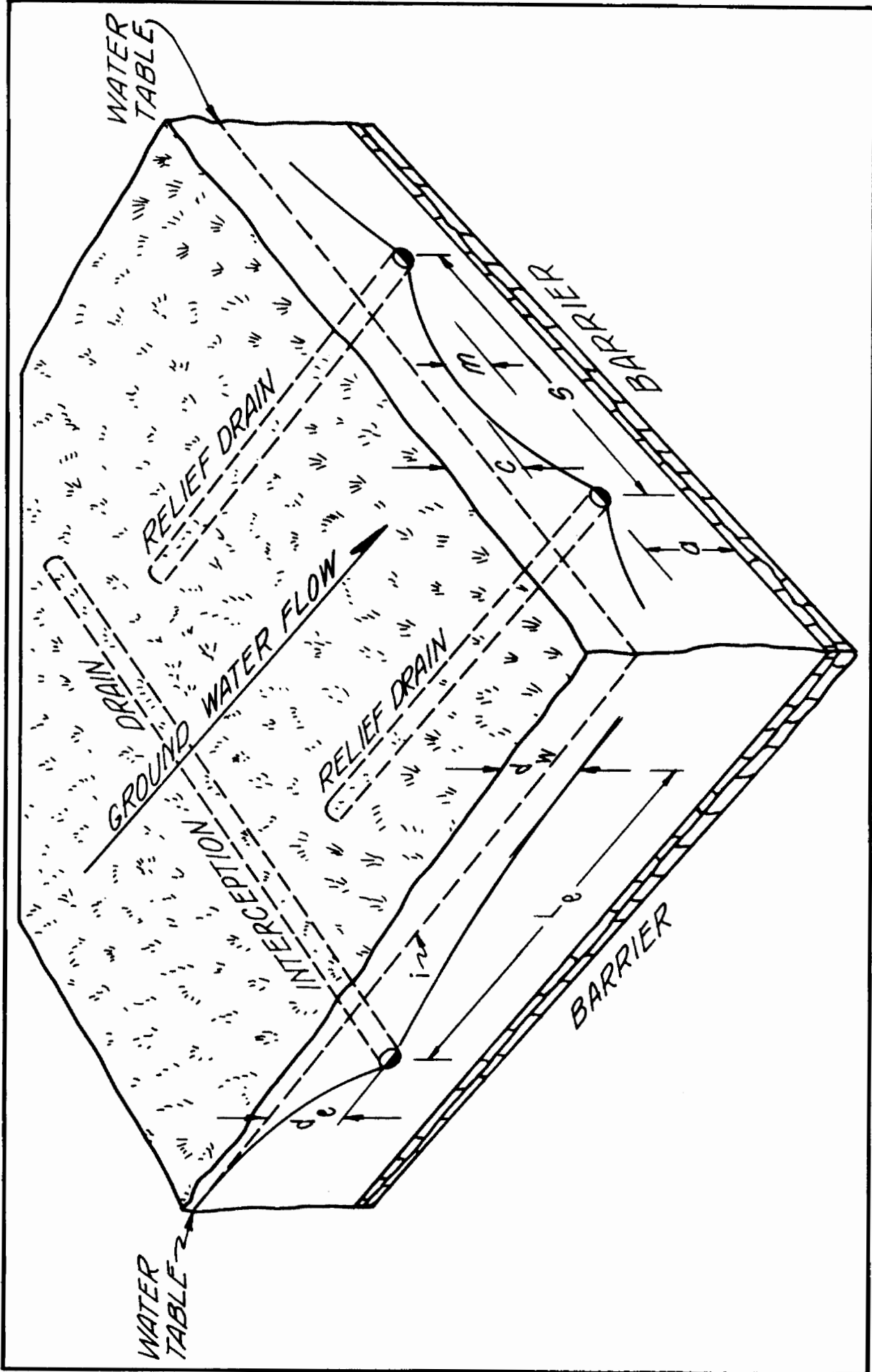

Figure 4-26, Isometric profiles relief and interception drains

more suitable to some site conditions and interception drains more suitable to others, but the choice of which to use will be largely dependent on the depth to barrier and the hydraulic gradient of the water table at the site. Two general rules that have been fairly well established through field experience are as follows:

1. Where a barrier is present at shallow depths (twice the drain depth or less), the effect of relief drains is seriously reduced and interception drains should be considered, other factors being suitable.
2. Where the hydraulic gradient of the water table is low, the effect of interception drains is seriously reduced and relief drains should be considered, other factors being suitable.

Relief drains

Humid areas. - In the humid areas of the United States, depth and spacing of drains have been largely determined by experience and judgment for specific soil conditions. Recommendations have been made in most areas for drain depth and spacing in the majority of soils needing drainage. Optimum drain depth for laterals is influenced by soil permeability, spacing, optimum depth of water table, crops, depth to impervious strata, and outlet depth for the system. In mineral soils the minimum cover over the drain should be 2 feet and in organic soils 2.5 feet. The drain trench depth usually varies from 30 to 60 inches. Increasing the depth of the drain where practical, will permit the use of wider spacing.

Spacing formulas have been used successfully in the humid area. Further correlation between various formulas and results obtained from existing installations are needed to determine the specific formula which can be used most successfully to determine drain spacing on land where experience is lacking.

Irrigated areas. - In irrigated areas of the semiarid and arid part of the United States, the depth of drains depends upon the same factors as in the humid areas with the additional requirement for control of salinity. This usually requires a depth of drains from 6 to 12 feet. Experience with effective installations in specific areas is utilized to select drain depths. Individual investigations are required to determine the most effective depth for drains. In general, drains should be as deep as practical and economical considering equipment available and cost of construction and maintenance. The depth of the outlet should be adequate to permit installation of drains at the depth required and to discharge above low flow in the outlet. This may require a sump and pump. The spacing of drains may be uniform for a given soil and will depend upon the hydraulic conductivity of the soil for the pre-determined depth, the required depth of drawdown midway between the drain, on the applicable drainage coefficient, and on the depth to the barrier.

Ellipse equation. - After the depth of the drain has been determined the spacing may be computed by formula. The particular formula selected for computing the spacing of relief drains is influenced by site conditions and experience obtained from drains installed by use of the formula. The ellipse equation is used extensively to determine the spacing of relief-type drains. It is usually expressed in the following form (refer to Figure 4-27).

$$S = \frac{\sqrt{4 K (m^2 + 2 a m)}}{q} \quad (\text{Eq. 4-8})$$

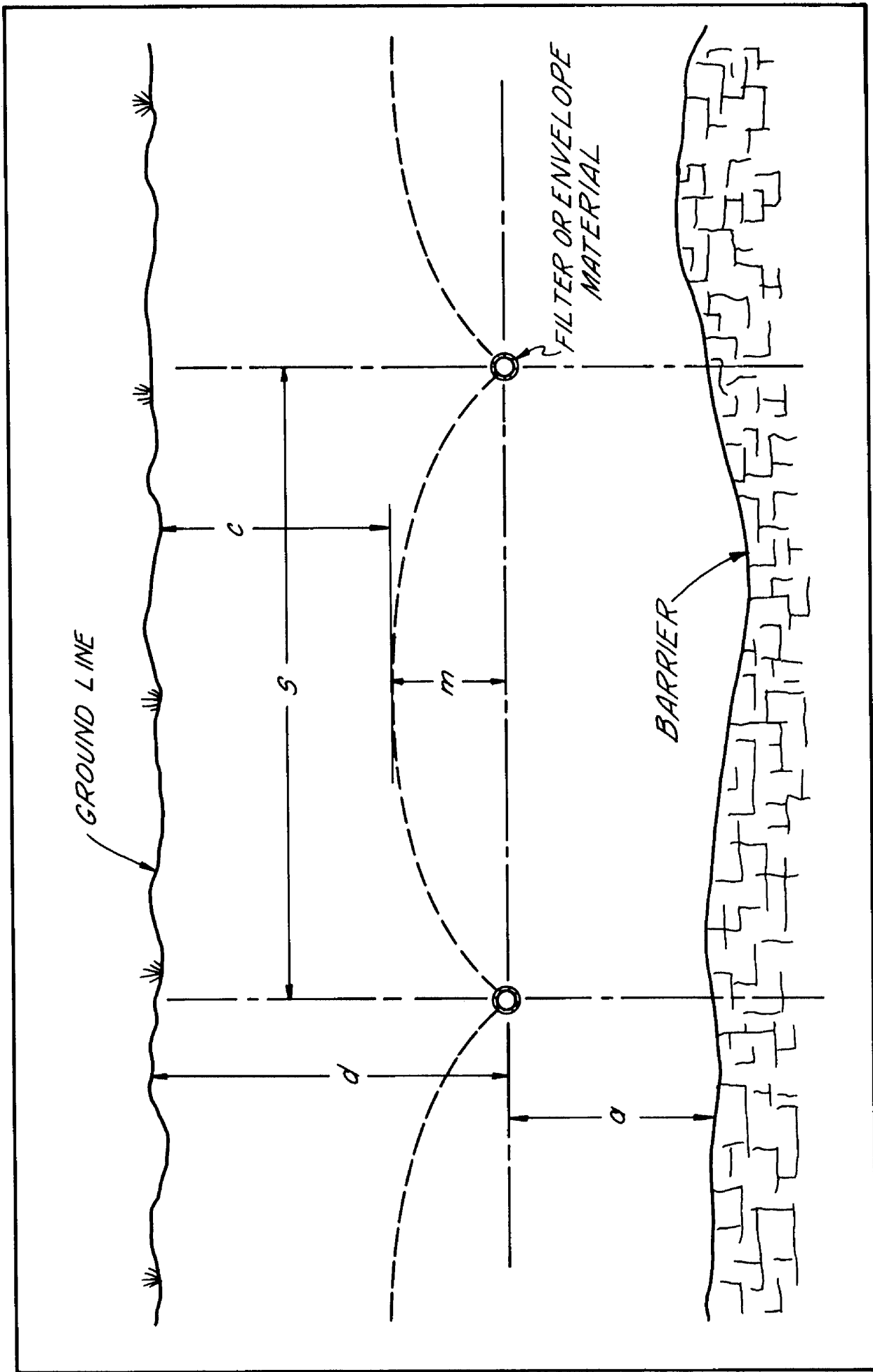

Figure 4-27, Cross-sectional sketch showing symbols used in ellipse equation

where:

- S = drain spacing--feet
- K = average hydraulic conductivity--in./hr.
- m = vertical distance, after drawdown, of water table above drain at midpoint between lines--feet
- a = depth of barrier below drain--feet
- q = drainage coefficient--in./hr.
- d = depth of drain--feet
- c = depth to water table desired--feet

NOTE: The units of K and q may be in "inches removal in 24 hours" or "gallons per square foot per day" but both must be in the same units in this equation.

The ellipse equation is based on the assumption that the streamlines of flow in a gravity system are horizontal and that the velocity of flow is proportional to the hydraulic gradient or the free water surface. Although it is known that these assumptions are only approximate, they may approach actual conditions very closely under certain site conditions. For this reason use of the formula should be limited to the following conditions:

1. Where ground-water flow is known to be largely in a horizontal direction. Examples of this are stratified soils with relatively permeable layers acting as horizontal aquifers.
2. Where soil and subsoil materials are underlain by a barrier at relatively shallow depths (twice the depth of the drain or less) which restricts vertical flow and forces the ground water to flow horizontally toward the drain.
3. Where open ditches are used, or where drains with sand and gravel filters or porous trench backfill materials are used. These are conditions where there is a minimum of restriction to flow into the drain itself and where convergence of flow at the drain is slight.

Example 1:

The following example is given to illustrate the use of this equation when variable (a) does not exceed the value of variable (d). (Figure 4-27).

1. Parallel relief drains are to be installed at a depth of 8 feet ($d = 8$).
2. Subsoil borings indicate an impervious barrier of shale at a depth of 15 feet below the ground surface: $a = (15 - d) = 7$.
3. The minimum depth to water table desired, after drainage, is 5 feet ($c = 5$), therefore: $m = (d - c) = 3$.

4. The average hydraulic conductivity of the subsurface materials is 2 inches per hour ($K = 2$).
5. The applicable drainage coefficient for the area is 0.01 in./hr. ($q = 0.01$).

$$S = \frac{\sqrt{4(2)(3^2 + 2(7) 3)}}{0.01} = 202 \text{ feet}$$

In actual practice this would be adjusted to conform with field dimensions. The precision of the data is such that an adjustment of 5 percent in the spacing is considered permissible.

Graphical solution of Example 1:

Figure 4-28 (sheets 1 and 2) are charts for the graphical solution of this equation. In order to use these charts it is necessary to know the values of a , m , K , and q . To illustrate the use of the charts the example given above is solved. Vertical scales are on the short dimension of charts.

$$a = 7 \text{ feet}$$

$$m = 3 \text{ feet}$$

$$(m + a) = 10 \text{ feet}$$

$$K = 2 \text{ in./hr.}$$

$$q = 0.01 \text{ in./hr.}$$

Step 1. Referring to Figure 4-28 (sheet 1), find $a = 7$ on the left-hand vertical scale. Project this horizontally to the right and find the point where it intersects the curve $(m + a) = 10$. From this point follow the vertical line up or down, as the case may be, to intersect the radial dashed line $K = 2$. From this point follow the horizontal line to the right-hand vertical scale and read the index number, 410. Note this index number down for continuation of the solution on Figure 4-28 (sheet 2).

Step 2. Referring to Figure 4-28 (sheet 2), find the index number 410 on the right-hand vertical scale. Project this point horizontally to the left to intersect with the curved line $q = 0.01$. From this point follow vertically down to read the spacing $S = 203$. This is the spacing in feet. This spacing is well within the 5 percent error and should be adjusted within acceptable limits to the spacing which will most nearly fit the dimensions of the field to be drained. For example, assume the dimension of the field, perpendicular to the direction of the drains, is 1,320 feet. Six drains will give a spacing of 220 feet, which is too great. Seven drains will give a spacing of 188 feet, which is satisfactory.

Modified ellipse equation. - As previously discussed in the text, the ellipse equation is satisfactory for computing drain spacing where the flow of ground water is largely horizontal, where the depth to barrier is less than twice the drain depth and where open ditches or drains or drains with sand-gravel envelopes or porous trench backfill materials are used. This will result in only a slight convergence of flow at the drains which can be ignored. For conditions where convergence is significant, it is necessary to modify the ellipse equation. This is true for the following site conditions.

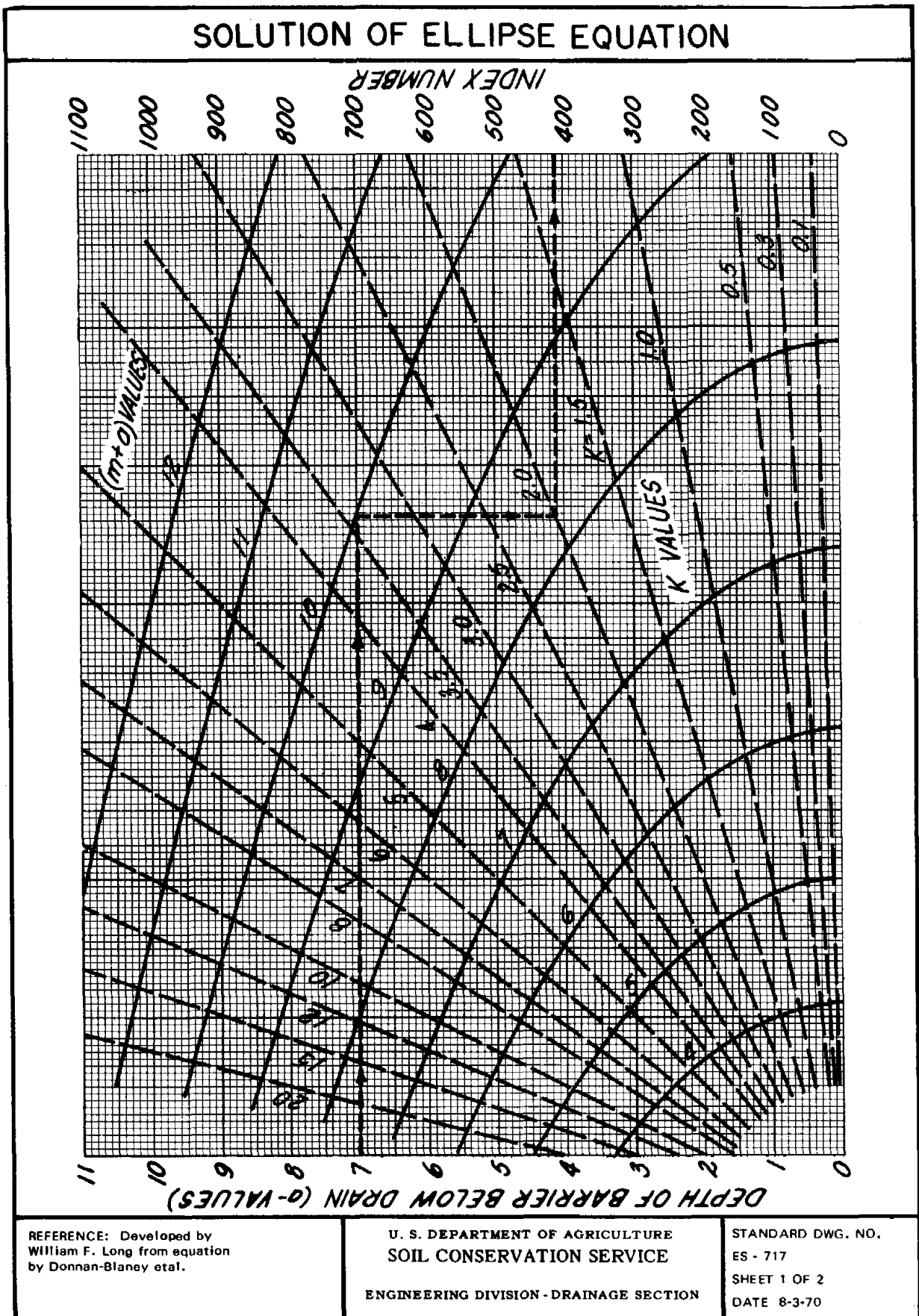
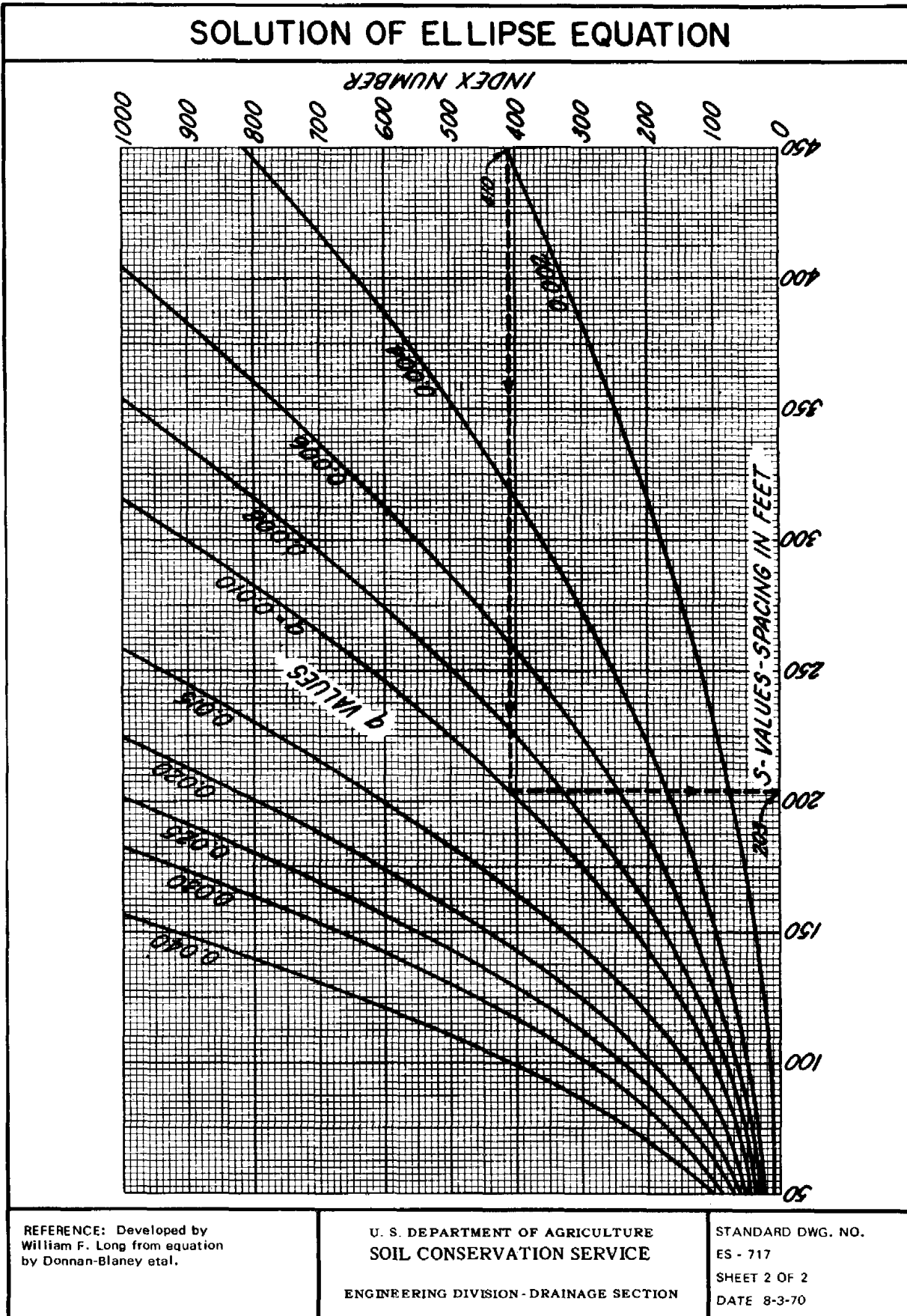

Figure 4-28, Solution of ellipse equation



REFERENCE: Developed by William F. Long from equation by Donnan-Blaney et al.

U. S. DEPARTMENT OF AGRICULTURE
SOIL CONSERVATION SERVICE
ENGINEERING DIVISION - DRAINAGE SECTION

STANDARD DWG. NO.
ES - 717
SHEET 2 OF 2
DATE 8-3-70

Figure 4-28, Solution of ellipse equation

1. Where soils and subsoils are deep homogeneous materials without horizontal stratification.
2. Where barriers, if present, are at depths in excess of twice the drain depth.
3. Where drains are placed without porous filters and where the trench backfill materials have a low permeability.

These are conditions where there is significant restriction to flow into the drain itself and where convergence of flow at the drain is significant.

Formulas to take into consideration the radial flow around drains have been developed by Hooghoudt and Ernst (see Chapter 1, page 1-21). Soil Conservation Service personnel have prepared charts for the direct solution of drain spacing based on Hooghoudt's tables and the units of measurement listed on page 4-59.

Hooghoudt's procedure (8) involves determination of an "equivalent depth" to the barrier below the drain and substituting this for the actual depth to barrier in the ellipse equation. This procedure is discussed, among others, by Bouwer and van Schilfhaarde (9). The charts mentioned above are not a direct solution of the ellipse equation but give a graphical solution of a modified ellipse equation in which an equivalent depth has been substituted for the depth to barrier.

The value of (a), the depth to barrier, as used in these charts is the actual depth to barrier below the drain.

1. Graphical solution - depth to barrier known. Figure 4-29 (sheets 1, 2, and 3) are actually parts of the same chart which has been subdivided into page-size-sheets for inclusion in this handbook. These charts give a graphical solution of the modified ellipse equation.

The graphical solution for the modified ellipse equation (using Figure 4-29) is satisfactory where the depth to barrier affects the drain spacing significantly. This is where the spacing is up to about four times the depth to barrier or S/a is greater than four.

The factors needed for solution by these charts are a , m , K , and q as defined on page 4-59 for the ellipse equation. In using these charts it is necessary to first compute the values of q/K and m/a and then select the appropriate chart. The range of each chart is as follows:

| <u>Figure</u> | <u>Values of q/K</u> | <u>Values of m/a</u> |
|----------------|-----------------------------------|-----------------------------------|
| 4-29 (sheet 1) | 0.0004 - 0.05 | 0.02 - 0.30 |
| 4-29 (sheet 2) | 0.001 - 0.10 | 0.30 - 7.0 |
| 4-29 (sheet 3) | 0.00001 - 0.001 | 0.30 - 7.0 |

From the proper chart find the point of intersection for values of q/K and m/a and interpolate for the value of S/a from the curves given. Multiply the S/a value obtained times the value of (a) to obtain the spacing. Use of these charts is illustrated by the following example:

SOLUTION OF MODIFIED ELLIPSE EQUATION

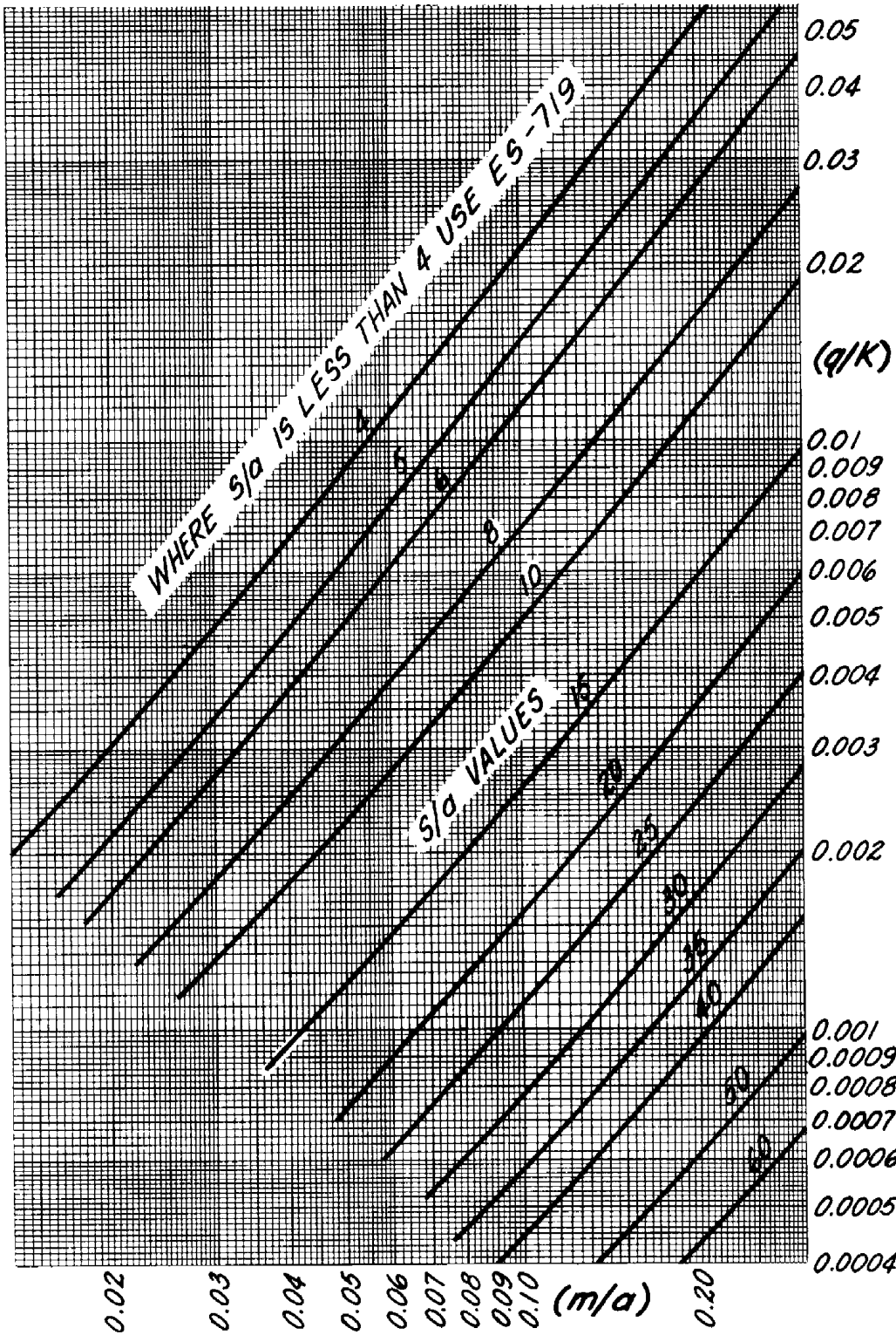

| | | |
|---|--|--|
| <p>REFERENCE: Developed by Bouwer-Schiffgaarde- Brownscombe-Long.</p> | <p>U. S. DEPARTMENT OF AGRICULTURE SOIL CONSERVATION SERVICE ENGINEERING DIVISION - DRAINAGE SECTION</p> | <p>STANDARD DWG. NO. ES - 718 SHEET 1 OF 3 DATE 8-3-70</p> |
|---|--|--|

Figure 4-29, Graphical solution of modified ellipse equation

SOLUTION OF MODIFIED ELLIPSE EQUATION

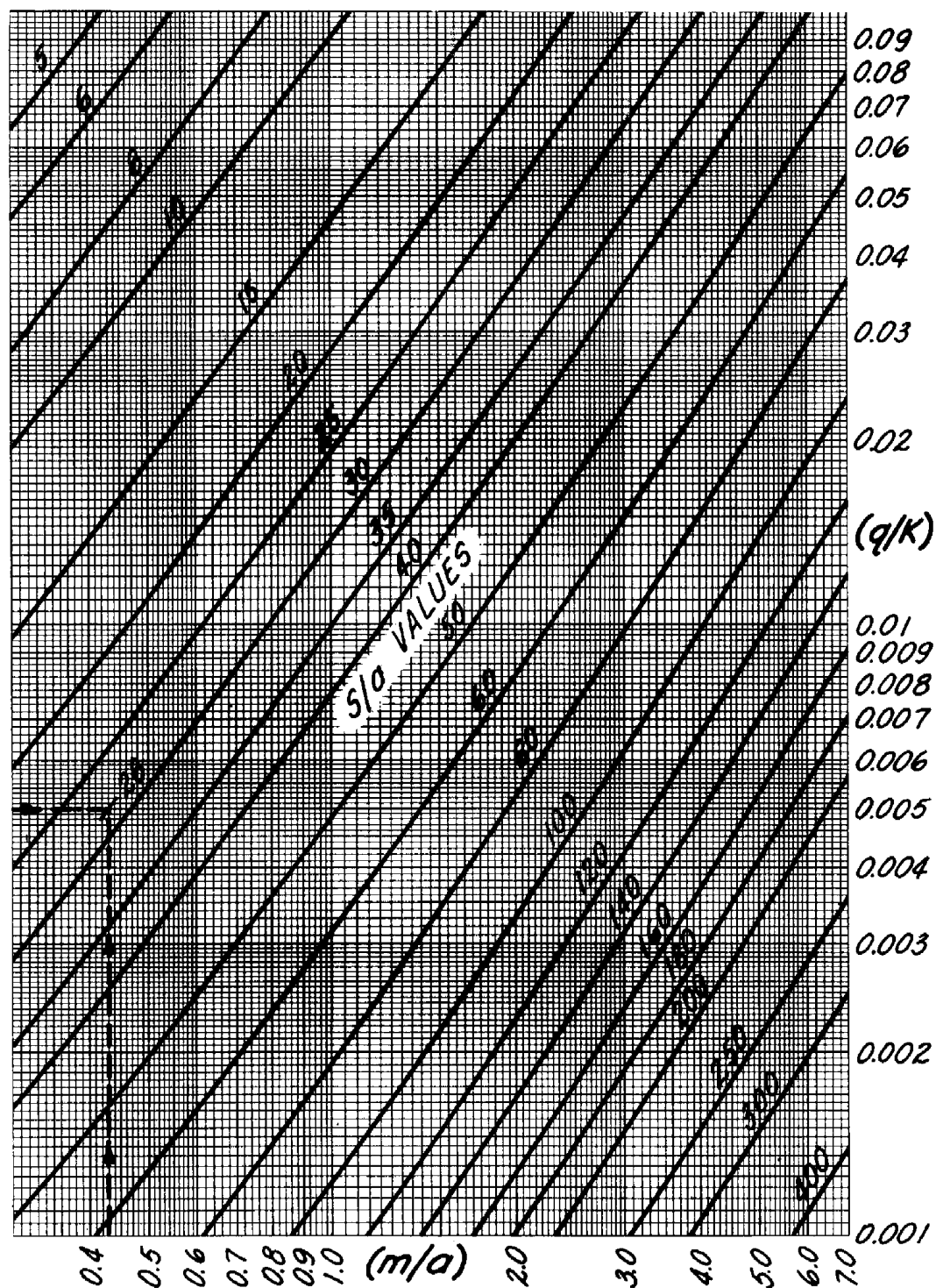

REFERENCE: Developed by
Bouwer-Schilfgaard-
Brownscombe-Long.

U. S. DEPARTMENT OF AGRICULTURE
SOIL CONSERVATION SERVICE
ENGINEERING DIVISION - DRAINAGE SECTION

STANDARD DWG. NO.
ES - 718
SHEET 2 OF 3
DATE 8-3-70

Figure 4-29, Graphical solution of modified ellipse equation

SOLUTION OF MODIFIED ELLIPSE EQUATION

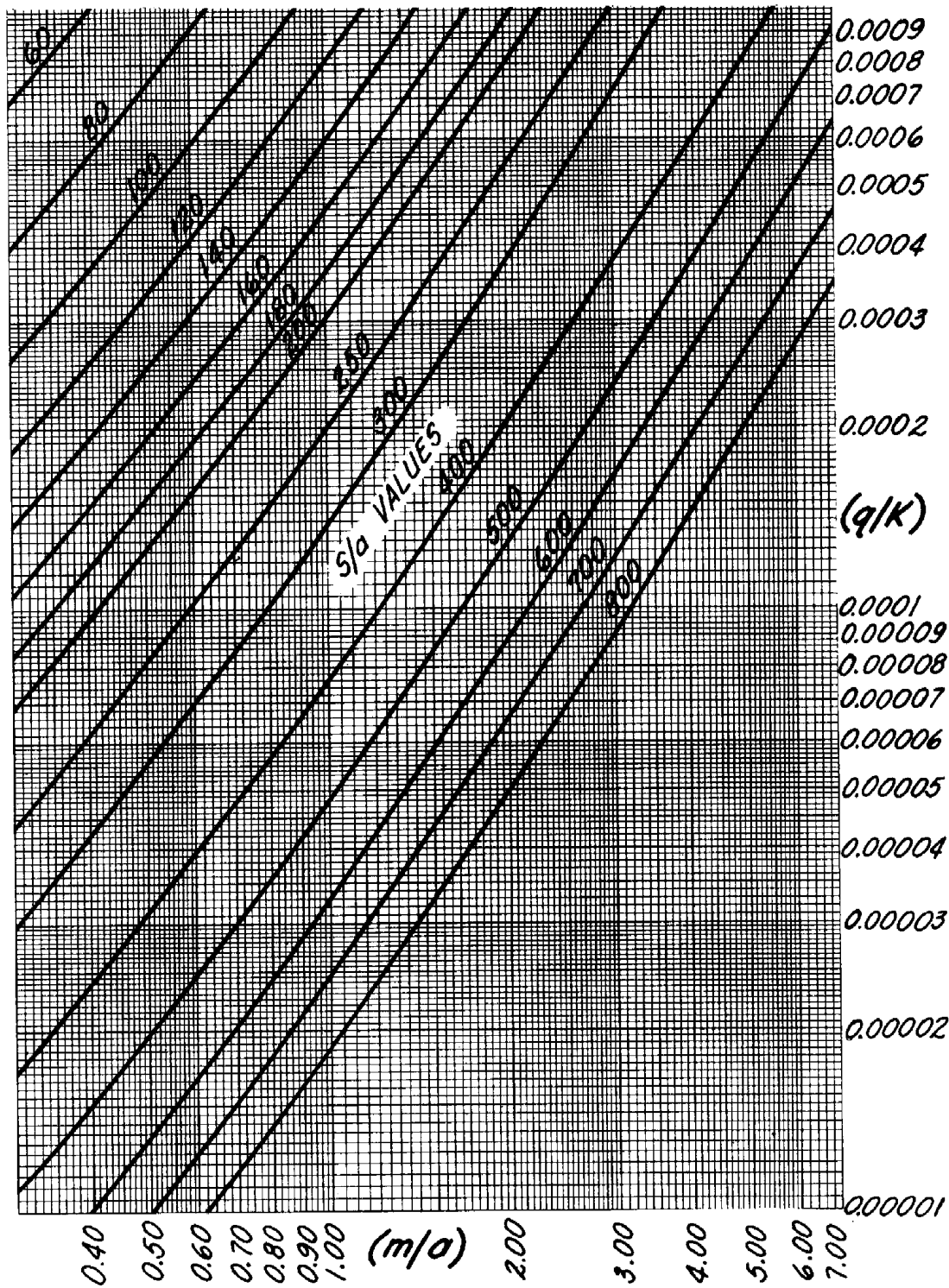

REFERENCE: Developed by
Bouwer-Schilfgaard-
Brownscombe-Long.

U. S. DEPARTMENT OF AGRICULTURE
SOIL CONSERVATION SERVICE
ENGINEERING DIVISION - DRAINAGE SECTION

STANDARD DWG. NO.
ES - 718
SHEET 3 OF 3
DATE 8-3-70

Figure 4-29, Graphical solution of modified ellipse equation

Example 2:

Determine the spacing for the conditions given in Example 1 illustrating use of the ellipse equation, 4-8, page 4-57:

where:

$$a = 7 \text{ feet}$$

$$m = 3 \text{ feet}$$

$$q = 0.01 \text{ in./hr.}$$

$$K = 2.0$$

Solution:

$$\frac{m}{a} = \frac{3}{7} = 0.43$$

$$\frac{q}{K} = \frac{0.01}{2} = 0.005$$

Refer to Figure 4-29 (sheet 2), find $S/a = 28$.

$$S = \frac{S}{a} \times a = 28 \times 7 = 196 \text{ feet}$$

The spacing is slightly less than the 202 feet obtained by using the ellipse equation. Differing values will be obtained for most cases where the depth to barrier is less than twice the drain depth as previously discussed. It will not be the case, where the barrier is at a greater depth.

2. Graphical solution - no barrier present or depth to barrier greater than one-fourth estimated spacing. Where there is no known barrier present or where its depth below the tile is greater than one-fourth the estimated spacing, the barrier will have no effect on the operation of the relief drain. For this case the barrier will be considered to be infinitely deep and the method described above is not applicable as there is no realistic value for (a). The smallest S/a value given in Figure 4-29 (sheet 1) is equal to four. If the value of S/a is less than four, the solution can be found by using Figure 4-30, which is discussed below.

The chart shown as Figure 4-30 has been prepared for graphical solution of the modified ellipse equation for the case where the depth to barrier is considered to be infinite. It will be noted that on this chart the vertical scale is in units of q/K and the horizontal scale in units of (S), the drain spacing. The family of curves on this chart is drawn for selected values of (m). To use this chart it is necessary to know the value of q/K and (m). Find q/K on the vertical scale; project this horizontally to the right to the proper curve for the value of (m) and from this point follow vertically down to read the value of (S) on the horizontal scale. This is the spacing in feet.

Example: Determine the spacing for the previous problem, assuming all conditions the same except that there is no barrier present, or that its depth is greater than one-fourth the estimated spacing where:

SOLUTION OF MODIFIED ELLIPSE EQUATION DEPTH TO BARRIER INFINITE

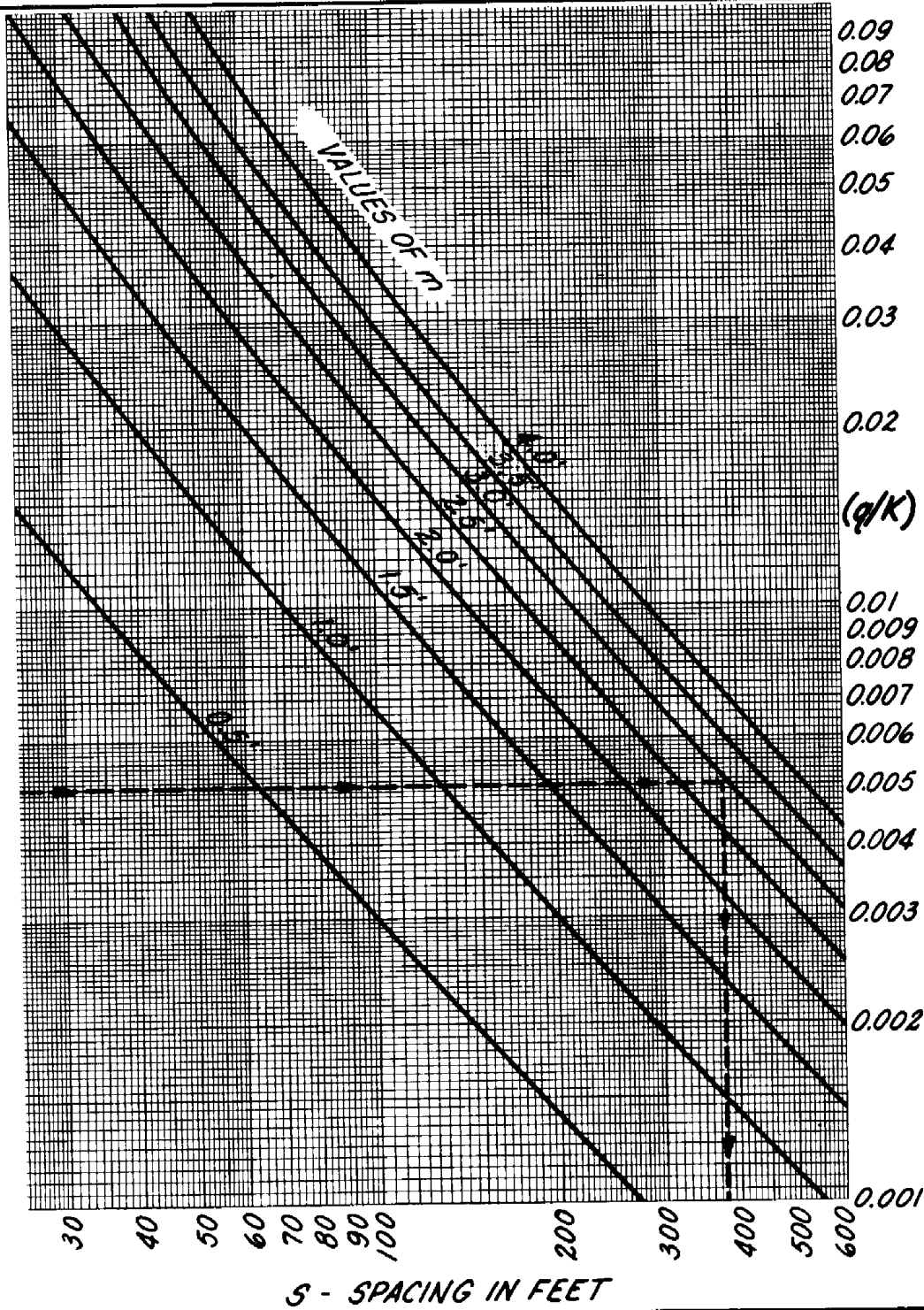

REFERENCE: Developed by
Bouwer-Schilfgaarde-
Brownscombe-Long.

U. S. DEPARTMENT OF AGRICULTURE
SOIL CONSERVATION SERVICE
ENGINEERING DIVISION - DRAINAGE SECTION

STANDARD DWG. NO.
ES - 719
SHEET 1 OF 1
DATE 8-3-70

Figure 4-30, Solution of modified ellipse equation

$$\frac{q}{K} = \frac{0.01}{2} = 0.005$$

The value of (m) is given. When $m = 3$ (from the chart, Figure 4-30)

$$S = 380 \text{ feet.}$$

Nomographs for the calculation of drain spacings have been developed by W. F. J. van Beers, Senior Research Officer, International Institute for Land Reclamation and Improvement, Wageningen, the Netherlands. Nomographs are included for calculation of drain spacing by use of the Hooghoudt and Ernst formulas, and for determination of drain spacing in accord with the transient flow concept developed by Glover and Dumm. See references (6, 7, 8, 10, and 11) in Chapter 1. The nomographs included in Bulletin 8 of the Institute are convenient to use when measurements are in metric units.

Van Beers' nomographs for solution of the Hooghoudt formula are applicable to drains in a homogeneous soil, and where the drains are on or below the interface between two soils of different permeabilities. When the drains are above the interface, the solution given by the Ernst formula is applicable. The nomograph for determination of drain spacing by the Glover and Dumm formula may be used when the nonsteady state or transient flow concept is applicable.

Artesian areas. - In areas that are subject to artesian flow from permeable aquifers, present below the drain, relief-type drains are usually installed to solve the problem. The proper depth and spacing for these drains are computed by using the formulae for relief drains as previously discussed; however, special consideration must be given to selecting drainage coefficients that are applicable to artesian conditions.

In nonartesian areas the drainage coefficient is based on the expected infiltration from precipitation and/or deep percolation from irrigation. In artesian areas ground water moves upward into the root zone in addition to water that infiltrates from the surface, so the amount of ground water to be removed by drainage is greater. For this reason drainage coefficients applicable to artesian areas are always greater than those applicable to nonartesian areas. This usually requires closer spacing of drains in artesian areas.

The rate at which ground water under artesian pressure moves upward into the root zone is a function of artesian pressure, the depth of the artesian aquifer below the drain and the permeability of the subsurface sediments through which the artesian water must flow. Knowing the values of these variables for a given situation, it is possible to compute the rate of artesian flow and to establish a drainage coefficient applicable to the accretion caused by artesian conditions. This, when added to the drainage coefficient locally established for accretion from precipitation or irrigation provides a drainage coefficient applicable to artesian areas. Experience has indicated that this coefficient is in the range of one and one-half to two times the normal values used in nonartesian areas.

Recognizing that we do not currently have a precise method of computing the value of accretions from artesian flow, the design of drainage systems should be conservative. Disposal drains, mains, and important lateral drains should be designed with some excess capacity. Lateral collector drains can be designed on a less conservative basis as additional collector drains can be installed to supplement the system if it is found to be deficient. This approach is often the most practical and least costly method in areas where

ground-water yields from artesian flows are indeterminate. The important consideration is to provide for excess capacity in the disposal system so that additional collector drains can be added later.

Use of open ditches for relief drainage. - Open ditches may be used to provide subsurface drainage and are often considered for use in flat fields where lack of grade, depth of outlet, soil characteristics, or economics do not favor buried drains. The ditches must be deep enough to provide for the escape of ground water found in permeable strata or in water-bearing sediments. Spacing of the ditches varies with soil permeability and crop requirements. Because of their required depth the ditches usually have adequate capacity to carry both surface and subsurface water. Advantages in using open ditches include the following:

1. Open ditches usually have a smaller initial cost than buried drains.
2. Inspection of open ditches is easily accomplished.
3. They are applicable in soils where buried drains are not recommended.
4. Open ditches may be used on a very flat gradient where the depth of the outlet is not adequate to permit gravity flow from drains installed at the required depth and grade.

Disadvantages in using open ditches are as follows:

1. Open ditches require considerable right-of-way which reduces the area of land available for other purposes.
2. Open ditches require more frequent and costly maintenance than buried drains.

Interception drains

Interception drains may be planned as single random drains or as a series of parallel drains. They are used where soils and subsoils are relatively permeable and where the gradient of the water table is relatively steep. Interception drains skim off or divert a portion of ground-water flow thereby lowering the water table in the area below or downslope from the interception drain. The distance that the water table is lowered below the drain is directly proportional to the depth of the drain; therefore it is desirable to make interception drains as deep as possible consistent with other factors. The upslope effect of interception drains varies with the hydraulic gradient, decreasing as the hydraulic gradient increases. This upslope effect of true interception drains is usually small and is often ignored.

Theoretically, a true interception drain lowers the water table downslope from the drain to a depth equal to the depth of the drain, and the distance downslope to which it is effective in lowering the water table is infinite, provided there is no accretion to ground water in that distance. Under field conditions, where there is infiltration from precipitation or deep percolation from irrigation, there is always accretion to ground water. The distance downslope from the drain to which it is effective is governed by the amount of these accretions.

In the design of interception drains it is usually necessary to estimate the downslope effect of interception drains to determine if one or several such drains are needed to lower the water table in the wet area. This is a diffi-

cult problem, but can be approached by use of an empirical equation or by progressive construction.

The equation is based on the assumption that the drain intercepts all the flow upslope from it to the depth of the drain, and the distance downslope to which it is effective is dependent on the depth of drainage required and the accretion to ground water in the area below the drain. Referring to Figure 4-31 this is the reach (L) from the drain to point (m) where the drain is no longer effective. For purposes of this discussion, a true interception drain is defined as one in which all ground-water flow enters the drain from the upslope side. Based on presently available information, true interception is thought to occur when the hydraulic gradient of the undisturbed water table is in the range of 0.01 to 0.03 feet per foot or greater. Where the gradient is less than this the interception drain functions more like a relief drain and the spacing should be computed using the ellipse equation, as previously discussed in this chapter. The equation is:

$$L_e = \frac{Ki}{q} (d_e - d_w + W_2) \quad (\text{Eq. 4-9})$$

where:

L_e = the distance downslope from the drain to the point where the water table is at the desired depth after drainage--feet

K = the average hydraulic conductivity of the subsurface profile to the depth of the drain--in./hr.

q = drainage coefficient--in./hr.

i = the hydraulic gradient of the water table before drainage (undisturbed state)--feet per foot

d_e = the effective depth of the drain--feet

d_w = the desired minimum depth to water table after drainage - based on agronomic recommendations--feet

W_1 = the distance from the ground surface to the water table at the drain--feet

W_2 = the distance from the ground surface to the water table, before drainage, at the distance (L_e) downslope from the drain--feet

In Equation 4-9, (L_e) and (W_2) are interdependent variables. In the solution of the equation it is necessary to estimate the value of (W_2) and make a trial computation. If the actual value of (W_2) at distance (L_e) is appreciably different, a second calculation may be indicated. In those cases where the gradient (i) is uniform throughout the area, (W_2) can be considered as equal to (W_1).

Example: Refer to Figure 4-31. Determine the distance downslope from an interception drain that it would be effective under the following given conditions:

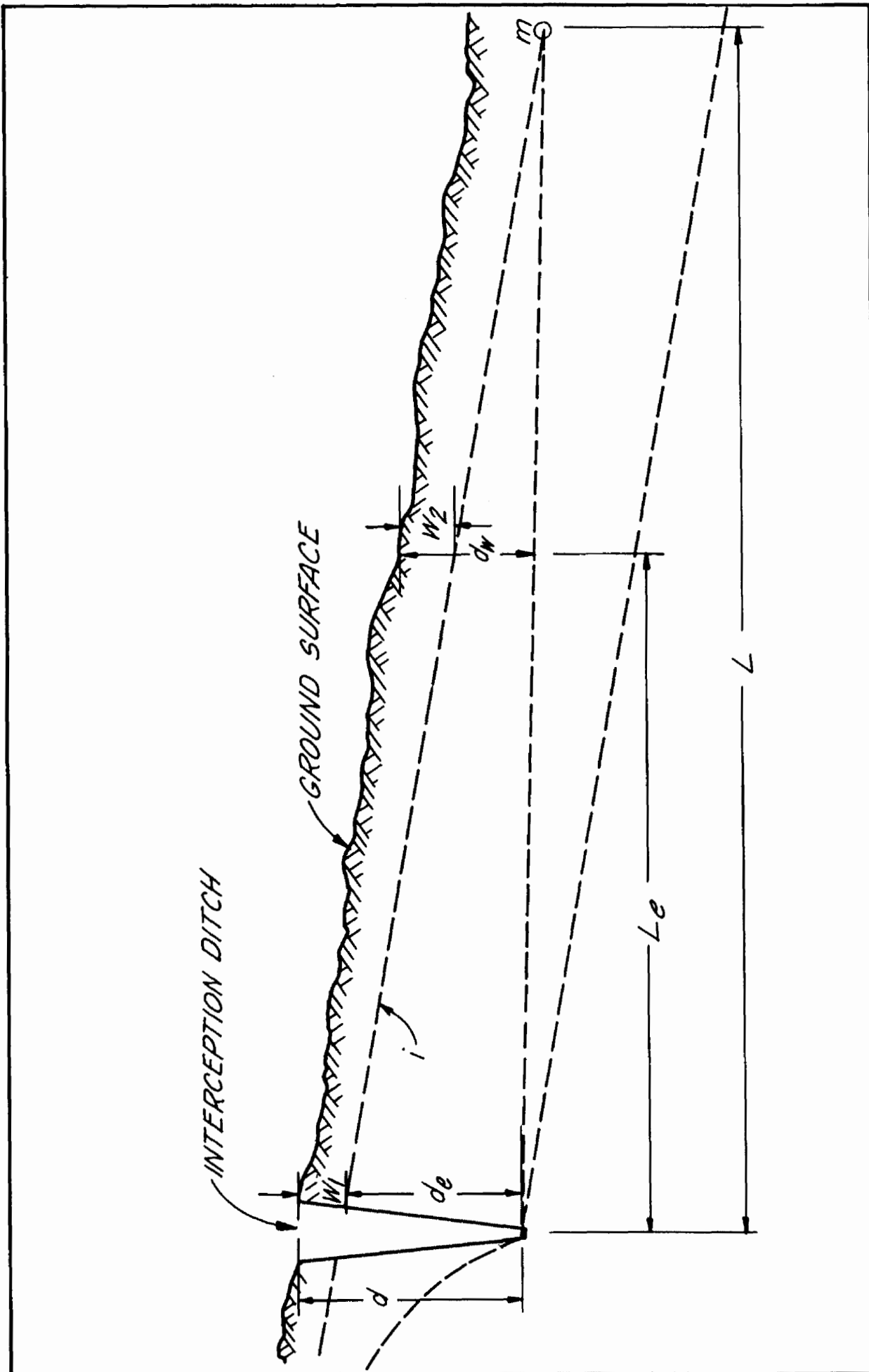

Figure 4-31, Cross-sectional profile, interception drain and area influenced

d = depth of drain--8 feet

W_1 = 1.5 feet

K = 6 in./hr. (from auger hole tests)

i = 0.05 (feet per foot)

q = 0.004 in./hr. (locally established drainage coefficient)

d_w = 3 feet (from local agronomic experience)

$d_e = d - W_1 = 8 - 1.5 = 6.5$ feet

Assume: $W_2 = W_1 = 1.5$ feet

$L_e = \frac{Ki}{q} (d_e - d_w + W_2)$

$L_e = \frac{(6)(0.05)}{(0.004)} (6.5 - 3 + 1.5) = 375$ feet

At a distance of 375 feet downslope from the drain, the depth to water table would be 3 feet. If two or more parallel interception drains are to be used, the spacing between the first and second drains would be 375 feet as computed above. The spacing between the second and third drain; third and fourth; etc. would have to be recomputed using adjusted values for (i) and (d_e) due to the change in the hydraulic gradient caused by the first interception drain.

Multiple interception drains. - Where it is necessary to install multiple interception drains, and site conditions are such that the above equation is not applicable, it may be feasible to install the system progressively and avoid the uncertainties of estimating spacing. This may be accomplished by constructing the first drain to protect the higher portion of the wet area and delaying construction of the lower drains to allow time to evaluate the effect of the first one. Spacing of additional drains can be accurately determined by exploring water table levels below the first drain to establish a spacing interval. Referring to Figure 4-31, the second interception drain would be located a distance (L_e) below the first drain, where the desired drawdown is effected. In actual practice this distance could be extended a short distance to allow for some upslope drawdown.

The upslope drawdown is a function of the depth of the drain and the hydraulic gradient as previously mentioned. As a general rule, it can be considered as equal to the reciprocal of the hydraulic gradient.

Mole drains

Moling should be undertaken only in the heavier mineral soils of fine texture such as clays, silty clays, or clay loams and in fibrous organic soils. The soil through which moles are drawn should be free of stones, gravel, and sand lenses. Clay content of mineral soils at moling depth should be about 40 percent or greater and sand content not over 20 percent. A rule-of-thumb test for appraising suitability of the soil can be made as follows:

Squeeze a sample of soil taken at the proposed moling depth into an approximate 2-1/2 to 3-inch ball. Immerse the ball in a jar of water

and leave undisturbed for about 12 to 14 hours. If the ball remains intact at the end of this time, the soil should be suitable for moling. Soils should be examined over the entire area to be moled.

Drainage area. - Upland surface runoff should not be permitted to collect on moled land. Such flow should be intercepted above the moled area and removed by diversion.

The area of land served by one or a system of mole drains should be limited to small acreages. The limit should not exceed 4 to 5 acres. When drainage of large fields is planned, the resulting layout may require an arrangement of drains involving a number of systems with separate outlets.

Grade. - Mole drains deteriorate rapidly on grades below 1 percent or more than 7 percent. Under 1 percent, moles tend to retain sufficient moisture to keep their walls soft and flaking and they do not flush themselves readily. Scour and erosion with resulting plugging occur on slopes more than 7 to 8 percent. Best grades are between 1 and 2 percent. Lines should be drawn with continuous slope toward the outlet. Land smoothing prior to moling can eliminate minor depressions in grade and remove any abrupt changes. If moles must be drawn through a depression, a buried drain should be installed for the outlet. On steep slopes lines are preferably drawn across slope on grades of 1 to 2 percent. See Figures 4-32 and 4-33 for examples of mole-drainage patterns suitable to steep and comparatively flatland slopes.

Outlets. - Mole outlets must have sufficient depth and capacity to provide continuous free outfall. Standing water or any prolonged inundation softens and collapses the mole cavity. Outlets for mole drains may be open ditches, buried drains, or other mole drains. Due to their importance as outlets to tributary mole drains, special care should be given to locations used for mole mains.

Discharging mole drains directly into open ditches or natural streams is undesirable, because of hazard of overflow and backwater, because of the possible presence of undesirable granular or organic strata, and because of direct exposure of the ends of the mole cavity to the deteriorating effect of frost, drought, rain, and surface waterflow. When moles must be drawn directly from ditches or streambanks, outlet protection should be provided by inserting 4 to 6 feet of pipe, of the same diameter as the mole, into the mole hole. When granular materials in the bank are a hazard, buried drains should be extended into the field or a short ditch opened back into the field from where the mole is then drawn.

Buried main drains provide the most stable outlet for mole drains. These should be installed before the moles are drawn and should be set sufficiently deep so that the mole can be drawn just over the drain without dislodging it. (Figure 4-34). Good entrance conditions between mole and drain may be provided by use of porous backfill material around and immediately over the drain. Buried drain outlets for mole drains should be planned according to the same requirements for the main drain of a subsurface system for similar conditions.

Moles, though less durable than tile, may be used as outlets to other mole lines. When used for mains three to four mole lines should be drawn side-by-side at about 3-foot spacing and at such depth that the tops of the mains will be cleared by the invert of the mole laterals drawn over them later. (Figure 4-35). Connections between the mains and laterals can be assured by opening

Figure 4-33, Mole drainage system on sloping land

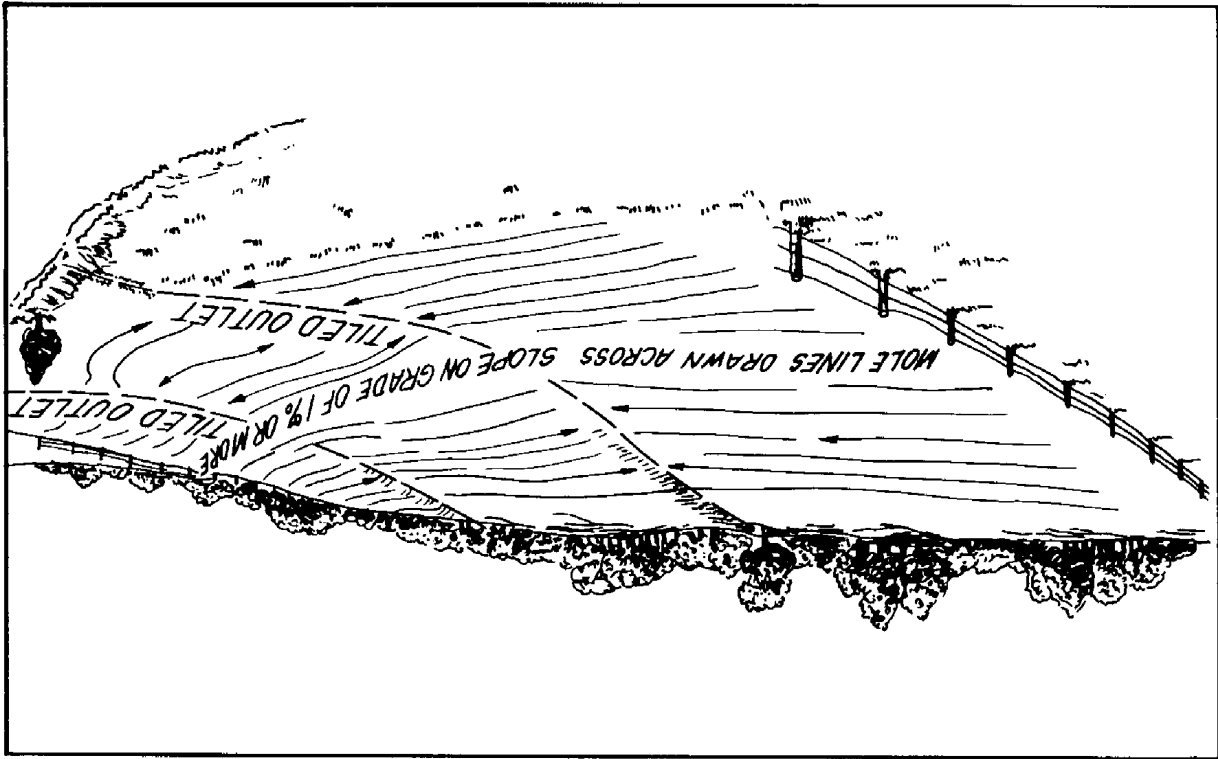
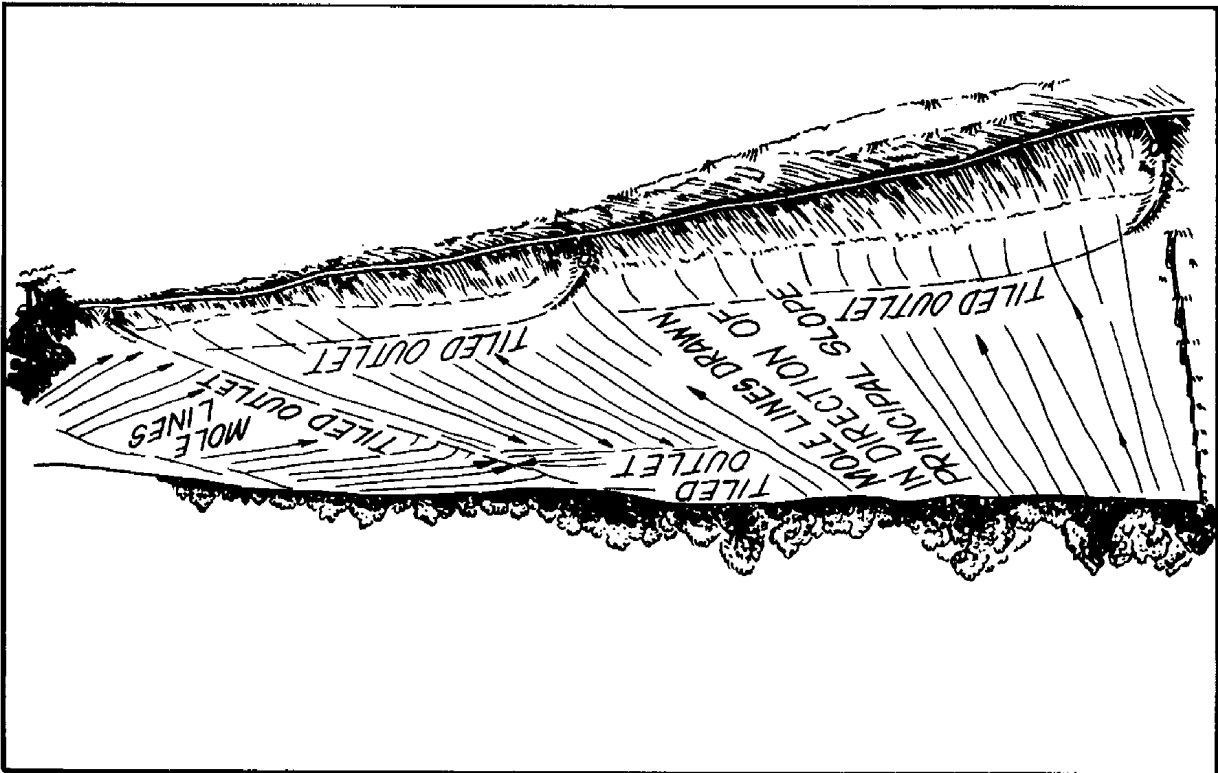

Figure 4-32, Mole drainage system on flatland



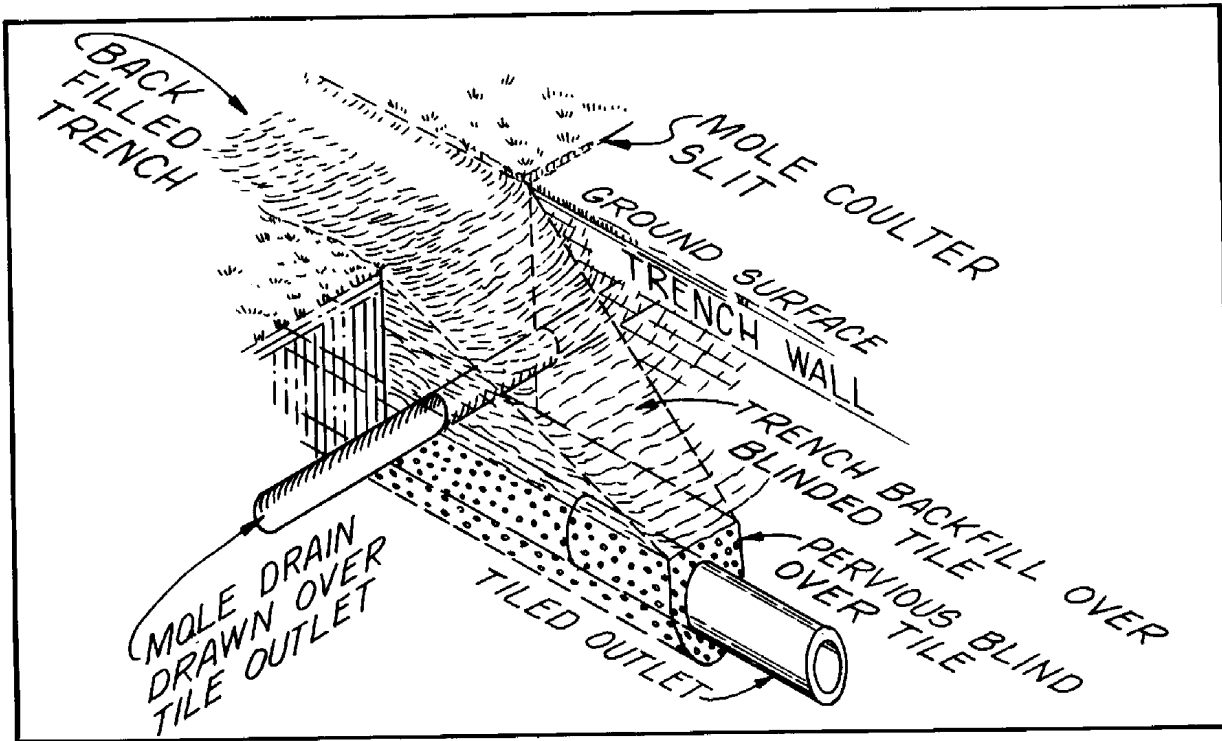

Figure 4-34, Buried drain outlet for mole drain

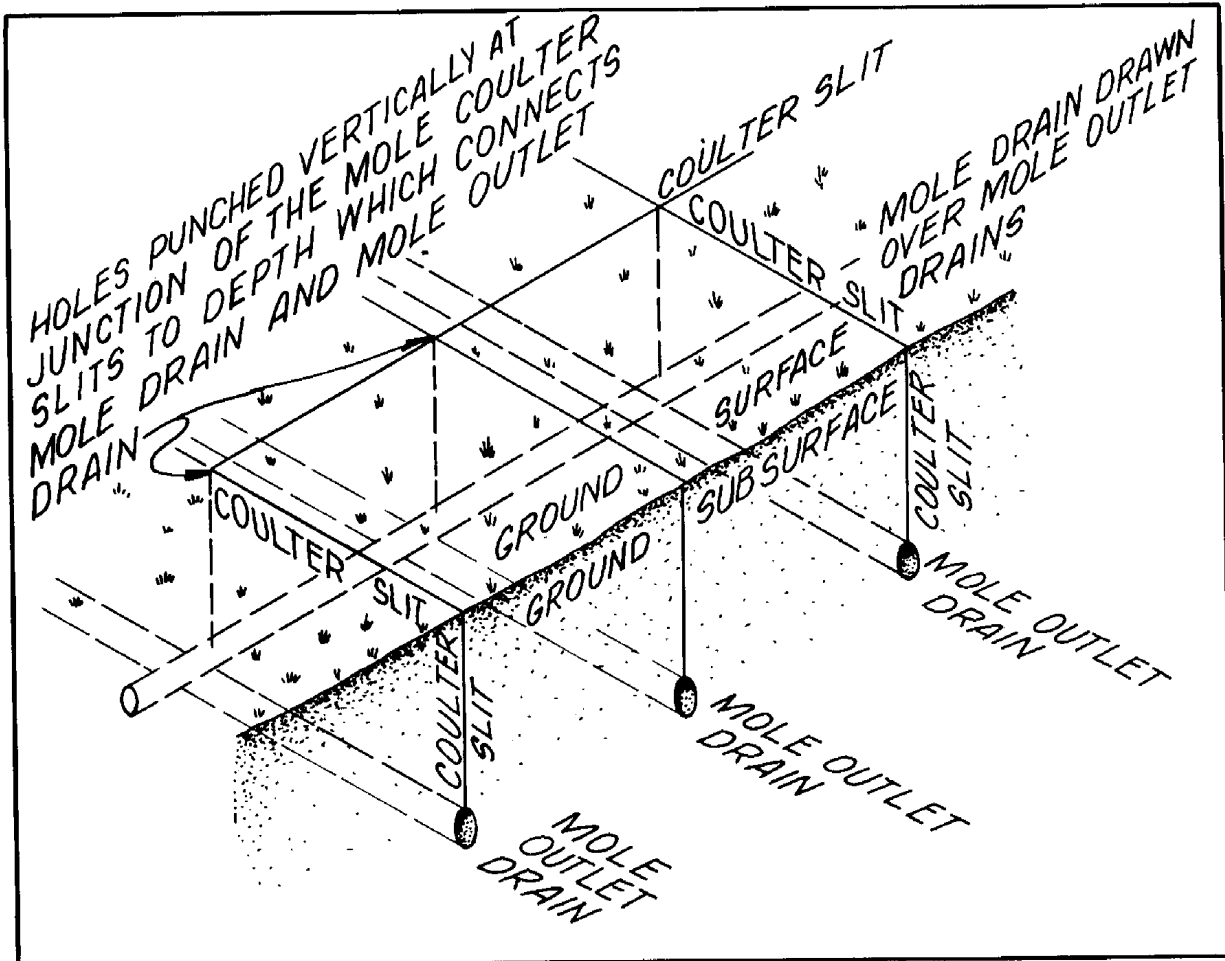

Figure 4-35, Mole drain outlets

up holes with a soil auger or metal bar, inserted over the junction of the two lines to the depth of the main.

Length of lines. - Size of the field to be moled, available outlet, and best location for the mains usually determine lengths of mole lines. Long lines deteriorate more rapidly than short lines. Experience indicates allowable lengths vary with soil type, slope, and area served. Maximum lengths of lines draining in one direction should not exceed 600 to 700 feet on the steeper grades. This length should be reduced as grade is reduced so that 350- to 400-foot lengths should be used on 2- to 4-percent grades and 250 feet or less on grades of 1 percent and less. The length specified above of a single-drawn mole line can be doubled when the grade is carried around the land slope or across ridges to provide fall in two directions. The drawn length of a line on comparatively flat grades of 1/2 to 1 percent can be extended many times by locating them across a series of draws in which mains are located.

Installation Design

General

The location of the main drain and laterals should be planned to obtain the most efficient and economical drainage system. A few general rules to follow are:

1. Provide the minimum number of outlets.
2. When practical lay out the system with a short main and long laterals.
3. Orient the laterals to use the available field slope to the best advantage.
4. Follow the general direction of natural waterways with mains and submains.
5. Avoid locations that result in excessive cut.
6. Avoid crossing waterways wherever feasible. If waterways must be crossed, use as near a right-angle crossing as the situation will permit.
7. Where feasible, avoid soil conditions that increase installation and maintenance cost.

Laterals should be located in the direction for the most effective collection of excess water, with due regard to the grade required for prevention of sedimentation, and following the rule of long laterals with short mains where feasible. Where the trenches are backfilled with permeable material that transmit water rapidly to the drain, it is desirable for laterals to be located at right angles to the direction of crop rows. Where it is desirable for main drains to be located parallel to a ditch deeper than the drain, enough distance should be maintained between ditch and drain to prevent washouts in the drain. Submains may be used to eliminate crossing waterways and to reduce the number of lateral connections to the main.

Alignment

When change in horizontal alignment is required, one of the following methods should be used to minimize head losses in the line:

1. Use of manufactured fittings, such as ells, T's, and Y's.
2. Use of a gradual curve of the drain trench to prevent excessive gap-space.
3. Use of junction boxes or manholes where more than two mains or laterals join.

Connections

Manufactured connections or junctions for joining two lines should be used. It is good practice to lay a submain parallel to a large tile main (usually 10 inches or larger) to prevent tapping the large main for each lateral. Tapping a large tile is difficult, costly, and is frequently the cause of failure. Savings, through the elimination of large connections, usually will offset the extra cost of a submain. Smooth curves in tile lines and manufactured tile connections or junctions of less than 90° have been recommended in the past on the assumption that energy losses at the junction of tile lines would be reduced. Investigations (10), however, show that the variation in energy loss for different angles of entry are insignificant from a practical standpoint when the main and lateral are of the same size and the drains are flowing full.

Loads on drains

General

Drains installed in the ground must have sufficient strength to withstand the loads placed upon them. In subsurface drainage, the load which usually governs the strength required is the weight of the earth covering the drain. The magnitude of the load which the drain can safely support depends upon the unit weight of the soil, the width and depth of the trench, and the method of bedding and installation of the drain. Where the drain is at shallow depths (3 feet or less) there is danger from impact loads from heavy farm equipment. All installations should be checked to insure adequate load-bearing strength.

Frequently drain installations are made in wide trenches and at greater depths than is possible with the average trenching machine. Draglines, backhoes, and other equipment may be used for deep trenches. Trenches excavated by this equipment are wide and the greater loads to be placed upon the drain must be determined so that a drain of adequate strength may be selected.

Underground conduits

Research on loads on underground conduits (including tile) has been carried on by Marston, Schlick, and Spangler and their associates at Iowa State University. The results of their work are used in determining the loads on underground conduits and their supporting strength. Information regarding loads on conduits may be found in the following publications.

"The Structural Design of Underground Conduits," SCS Engineering Division, Technical Release No. 5.

Engineering Handbook, Section 6, "Structural Design," U. S. Department of Agriculture, Soil Conservation Service.

"Soil Engineering," by Merlin Grant Spangler, International Textbook Company, Scranton, Pennsylvania.

"Design Data - Loads and Supporting Strengths," American Concrete Pipe Association, Arlington, Virginia.

"Handbook of Drainage and Construction Products," Armco Drainage and Metal Products, Inc., Middletown, Ohio.

Classification of conduits as to rigidity

Conduits used for subsurface drains may be of several kinds of materials. One characteristic of these various conduits which is important in determining the load-bearing strength is the degree of flexibility. Two classes of conduits according to their flexibility are as follows (11):

1. Rigid conduits, such as concrete, or clay, fail by rupture of the pipe walls. Their principal load supporting ability lies in the inherent strength or stiffness of the pipe.
2. Flexible conduits, such as corrugated metal pipes, and certain types of plastic pipe fail by deflection. Flexible conduits rely only partly on their inherent strength to resist external loads. In deflecting the horizontal diameter increases, compresses the soil at the sides, and thereby builds up passive resistance which in turn helps support the vertically applied load.

Classification of conduits based on installation

Practically all of the conduits installed for drainage will be installed as ditch conduits. A ditch conduit is one which is installed in a relatively narrow trench dug in undisturbed soil and covered with earth backfill. Conduits installed in trenches wider than about two or three times the outside diameter of the conduit may be treated as projecting conduits. Refer to National Engineering Handbook, Section 6, Structural Design, for a comprehensive analysis of loads on underground conduits.

Bedding conditions for rigid ditch conduits. - The supporting strength of a conduit will vary with bedding conditions. Two types of bedding are generally used in drainage work and each has a load factor which, when multiplied by the three-edge bearing strength, will give the safe supporting strength of the conduit.

1. Impermissible bedding is that method of bedding a ditch conduit in which little or no care is given to shape the foundation to fit the lower part of the conduit or to refill all the spaces under and around the conduit with granular material. The load factor for this type of installation is 1.1.
2. Ordinary bedding is that method of bedding a ditch conduit in which the conduit is bedded with ordinary care in an earth foundation shaped to fit the lower part of the conduit for a width of at least 50 percent of the conduit breadth, and in which the remainder of the conduit is surrounded to a height of at least 0.5 foot above its top by granular materials that are shovel-placed and shovel-tamped to

Table 4-5, Maximum allowable trench depths

MAXIMUM ALLOWABLE TRENCH DEPTHS, RIGID CONDUITS

| 3-EDGE BEARING CRUSHING STRENGTH | TILE DIAMETER | TRENCH WIDTH (INCHES) | | | | | | | |
|-------------------------------------|------------------|-----------------------|-----|-----|----|----|----|----|----|
| | | 18 | 21 | 24 | 27 | 30 | 36 | 42 | 48 |
| 800 | 4,5,6 | 9 | 7 | 7 | 7 | 7 | 7 | 7 | 7 |
| 800 | 8 | 9 | 7 | 6 | 6 | 6 | 6 | 6 | 6 |
| 800 | 10 | 10 | 7 | 6 | 5 | 5 | 5 | 5 | 5 |
| 800 | 12 | | 7 | 6 | 5 | 5 | 5 | 5 | 5 |
| 840 | 14 | | | 6 | 5 | 5 | 5 | 5 | 5 |
| 870 | 15 | | | 6 | 5 | 5 | 5 | 5 | 5 |
| 1000 | 6 | 19 | 9 | 8 | 8 | 8 | 8 | 8 | 8 |
| 1000 | 8 | 19 | 9 | 7 | 7 | 7 | 7 | 7 | 7 |
| 1100 | 4,5,6 | 25+ | 11 | 9 | 9 | 9 | 9 | 9 | 9 |
| 1100 | 8 | 25+ | 11 | 8 | 7 | 7 | 7 | 7 | 7 |
| 1100 | 10 | 25+ | 11 | 8 | 7 | 6 | 6 | 6 | 6 |
| 1100 | 12 | | 11 | 8 | 7 | 6 | 6 | 6 | 6 |
| 1100 | 15 | | | 8 | 7 | 5 | 5 | 5 | 5 |
| 1150 | 15 | | | 9 | 7 | 6 | 5 | 5 | 5 |
| 1200 | 12 | | 14 | 9 | 7 | 6 | 6 | 6 | 6 |
| 1200 | 16 | | | 10 | 8 | 7 | 5 | 5 | 5 |
| 1200 | 18 | | | | 8 | 7 | 5 | 5 | 5 |
| 1250 | 4,5,6 | 25+ | 16 | 11 | 11 | 11 | 11 | 11 | 11 |
| 1300 | 4,5,6 | 25+ | 18 | 11 | 11 | 11 | 11 | 11 | 11 |
| 1300 | 8 | 25+ | 18 | 11 | 8 | 8 | 8 | 8 | 8 |
| 1300 | 18 | | | | 9 | 7 | 5 | 5 | 5 |
| 1350 | 8 | 25+ | 22 | 11 | 9 | 9 | 9 | 9 | 9 |
| 1400 | 4,5,6 | 25+ | 25+ | 12 | 10 | 10 | 10 | 10 | 10 |
| 1400 | 10 | 25+ | 25+ | 12 | 9 | 8 | 8 | 8 | 8 |
| 1400 | 15 | | | 13 | 9 | 8 | 6 | 6 | 6 |
| 1450 | 4,5,6 | 25+ | 25+ | 13 | 11 | 11 | 11 | 11 | 11 |
| 1500 | 8 | 25+ | 25+ | 14 | 10 | 9 | 9 | 9 | 9 |
| 1500 | 12 | | | 14 | 10 | 8 | 7 | 7 | 7 |
| 1550 | 10 | 25+ | 25+ | 15 | 11 | 9 | 8 | 8 | 8 |
| 1600 | 4,5,6 | 25+ | 25+ | 16 | 12 | 12 | 12 | 12 | 12 |
| 1600 | 8 | 25+ | 25+ | 16 | 11 | 10 | 10 | 10 | 10 |
| 1600 | 10 | 25+ | 25+ | 17 | 11 | 9 | 9 | 9 | 9 |
| 1600 | 14 | | | 17 | 12 | 8 | 7 | 7 | 7 |
| 1650 | 15 | | | 19 | 12 | 10 | 7 | 7 | 7 |
| 1700 | 8 | 25+ | 25+ | 25 | 12 | 11 | 11 | 11 | 11 |
| 1700 | 12 | | | 25 | 12 | 10 | 8 | 8 | 8 |
| 1700 | 16 | | | 25 | 13 | 11 | 8 | 7 | 7 |
| 1700 | 18 | | | | 13 | 11 | 8 | 7 | 7 |
| 1750 | 15 | | | 25 | 14 | 11 | 8 | 7 | 7 |
| 1800 | 8 | 25+ | 25+ | 25+ | 14 | 11 | 8 | 8 | 8 |
| 1800 | 12 | | | 25+ | 15 | 11 | 8 | 7 | 7 |
| 1800 | 18 | | | | 15 | 11 | 8 | 7 | 7 |
| 1850 | 14 | | | | 15 | 11 | 8 | 8 | 8 |
| 2000 | 4,5,6 | 25+ | 25+ | 25+ | 19 | 14 | 14 | 14 | 14 |
| 2000 | 8 | 25+ | 25+ | 25+ | 19 | 12 | 12 | 12 | 12 |
| 2000 | 10 | | 25+ | 25+ | 19 | 13 | 10 | 10 | 10 |
| 2000 | 18 | | | | 20 | 14 | 9 | 7 | 7 |

Based on: K_u & K_u' = 0.13, Load Factor 1.5, Safety Factor 1.5, weight of soil - 120 lb./cu.ft.

REFERENCE: Technical Release No. 5. This chart was developed by Guy B. Fasken.

U. S. DEPARTMENT OF AGRICULTURE
SOIL CONSERVATION SERVICE
ENGINEERING DIVISION - DRAINAGE SECTION

STANDARD DWG. NO.

ES-720

SHEET 1 OF 1

DATE 8-3-70

completely fill all spaces under and adjacent to the conduit. The load factor for this type of installation is 1.5.

When sand and gravel filter or envelopes are used, the foundation need not be shaped since the filter and envelope material are placed entirely around the conduit and provide for lateral pressures on the conduit. With this type of installation the supporting strength of the conduit is increased above the three-edge bearing strength. Depending on its gradation and the care used in placing the sand-gravel filter or envelope, the load factor will be in the range of 1.2 for a poorly graded envelope of irregular thickness to 1.5 for a well-graded filter of uniform thickness around the drain. To be effective the filter or envelope should have a minimum thickness of 3 inches.

Trench depth for rigid conduits. - Table 4-5 was prepared for various sizes of conduits, types of conduits, trench widths, and types of bedding. The table is based upon a soil weight of 120 pounds per cubic foot and includes a safety factor of 1.5.

Bedding conditions for flexible drainage tubing. - A flexible conduit has relatively little inherent load-bearing strength, and its ability to support soil loadings in a trench must be derived from pressures induced as the sides of the conduit deflect and move against the soil. This ability of a flexible conduit to deform and utilize the soil pressure to support it is the main reason that light-weight plastic drainage tubing can support soil loadings imposed in drainage trenches.

A flexible tubing must be installed in a trench in a way which insures good soil support from all sides. There must be no voids remaining which would permit the soil pressure from backfill to cause deflection of the tubing to the point of buckling. Most installations will be made with machinery, without requiring a man in the trench to position the tubing or place the bedding. Some modification of machinery designed for installation of rigid conduits usually is necessary to install flexible conduits efficiently. See the section on installation of corrugated plastic drainage tubing, page 4-111.

Drain grades and velocities

Subsurface drains are placed at rather uniform depths; therefore, the topography of the land may dictate the range of grades available. There is often an opportunity, however, to orient the drains within the field in order to obtain a desirable grade. The selected grades should, if possible, be sufficient to result in a nonsilting velocity which experience has shown is about 1.4 feet per second, but less than that which will cause turbulence and undermining of the drain. Where siltation is a hazard (refer to Table 4-7, page 4-91), and the velocity is less than 1.4 feet per second, siltation may be prevented by use of filters and silt traps.

Where siltation is not a hazard, the recommended minimum grades are as follows:

| | <u>Percent</u> |
|----------|----------------|
| 4" drain | .10 |
| 5" drain | .07 |
| 6" drain | .05 |

On sites where topographic conditions require the use of drains on steep grades which will result in velocities greater than shown in the following table, special measures should be used to protect the line.

| <u>Soil Texture</u> | <u>Velocity-ft./sec.</u> |
|-----------------------|--------------------------|
| Sand and Sandy Loam | 3.5 |
| Silt and Silt Loam | 5.0 |
| Silty Clay Loam | 6.0 |
| Clay and Clay Loam | 7.0 |
| Coarse Sand or Gravel | 9.0 |

The protective measures may include one or more of the following:

1. Use only drains that are uniform in size and shape and with smooth ends.
2. Lay the drains so as to secure a tight fit with the inside diameter of one section matching that of the adjoining sections.
3. Wrap open joints with tar impregnated paper, burlap, or special filter material such as plastic or fiber-glass fabrics.
4. Select the least erodible soil available for blinding.
5. Use long sections of perforated pipe or tubing. (Bituminized fiber, plastic, asbestos cement, etc.).

Table 4-6 gives the grades for different sizes of drains which will result in the critical velocities discussed above. Data is given for drains with "n" values of 0.011 to 0.015.

Determining drain size

Drains ordinarily are not designed to flow under pressure and the hydraulic gradient is considered to be parallel with the grade line. The flow in the drain is considered to be open-channel flow. The size of drain required for a given capacity is dependent on the hydraulic gradient and the roughness coefficient--"n" value-- of the drain. Materials commonly used for drains have "n" values ranging from about 0.011 for good quality clay and concrete tile with good joint alignment to about 0.016 for corrugated plastic drainage tubing. When determining the size of drain required for a particular situation the "n" value of the product to be used must be known. The size drain required for a given capacity and hydraulic gradient and for three different "n" values may be determined from Figure 4-36 (sheets 1, 2, and 3). The shaded area in the charts indicates where the velocity of flow is less than 1.4 feet per second to indicate where drain filters may be required.

Example:

A drain on a 0.2 percent grade ($s = 0.002$) is required to discharge 1.5 cubic feet per second. What size drain will be required if the drain to be used has a roughness coefficient of 0.011? Find the hydraulic gradient of 0.002 on the horizontal scale in Figure 4-36 and follow vertically upward to intersect the line representing a discharge of 1.5 cubic feet per second. This point falls in the space between the lines marked 10 to 12 inches in diameter. A 12-inch drain is required. Since the point of intersection is below the line marked 12 inches, the drain will not flow full. The full capacity of the drain is 1.9 cfs. The drain will flow about 79 percent full for the design discharge. The same procedure is followed when using Figure 4-36 (sheets 2 and 3) for roughness coefficients of 0.013 and 0.015.

Table 4-6 - Drain grades and velocities

| Drain Size Inches | Grade - feet per 100 feet | | | | | |
|---------------------------------------|---------------------------|---------|---------|---------|---------|---------|
| | 1.4 fps | 3.5 fps | 5.0 fps | 6.0 fps | 7.0 fps | 9.0 fps |
| <u>For drains with "n" = 0.011 1/</u> | | | | | | |
| 4 | .28 | 1.8 | 3.6 | 5.1 | 7.0 | 11.5 |
| 5 | .21 | 1.3 | 2.7 | 3.9 | 5.3 | 8.7 |
| 6 | .17 | 1.0 | 2.1 | 3.1 | 4.1 | 6.9 |
| 8 | .11 | 0.7 | 1.4 | 2.1 | 2.8 | 4.6 |
| 10 | .08 | 0.5 | 1.1 | 1.5 | 2.1 | 3.5 |
| 12 | .07 | 0.4 | 0.8 | 1.2 | 1.6 | 2.7 |
| <u>For drains with "n" = 0.013</u> | | | | | | |
| 4 | .41 | 2.5 | 5.2 | 7.5 | 10.2 | 16.8 |
| 5 | .31 | 1.9 | 3.9 | 5.6 | 7.7 | 12.7 |
| 6 | .24 | 1.5 | 3.1 | 4.4 | 6.0 | 10.0 |
| 8 | .17 | 1.0 | 2.1 | 3.0 | 4.1 | 6.8 |
| 10 | .12 | .8 | 1.6 | 2.2 | 3.0 | 5.0 |
| 12 | .09 | .6 | 1.2 | 1.8 | 2.4 | 3.9 |
| <u>For drains with "n" = 0.015 2/</u> | | | | | | |
| 4 | .53 | 3.3 | 6.8 | 9.8 | 13.3 | 21.9 |
| 5 | .40 | 2.5 | 5.1 | 7.3 | 9.9 | 16.6 |
| 6 | .32 | 2.0 | 4.0 | 5.8 | 7.9 | 13.2 |
| 8 | .21 | 1.3 | 2.7 | 3.9 | 5.3 | 8.8 |
| 10 | .16 | 1.0 | 2.0 | 2.9 | 4.0 | 6.6 |
| 12 | .13 | .8 | 1.6 | 2.3 | 3.1 | 5.1 |

1/ $v = 138 r^{2/3} S^{1/2}$ - Laboratory "n" value = .01077

2/ $v = 100 r^{2/3} S^{1/2} \frac{1.486}{.015} = 99.06$ - rounded to 100

DRAIN CAPACITY CHART - $n = 0.011$

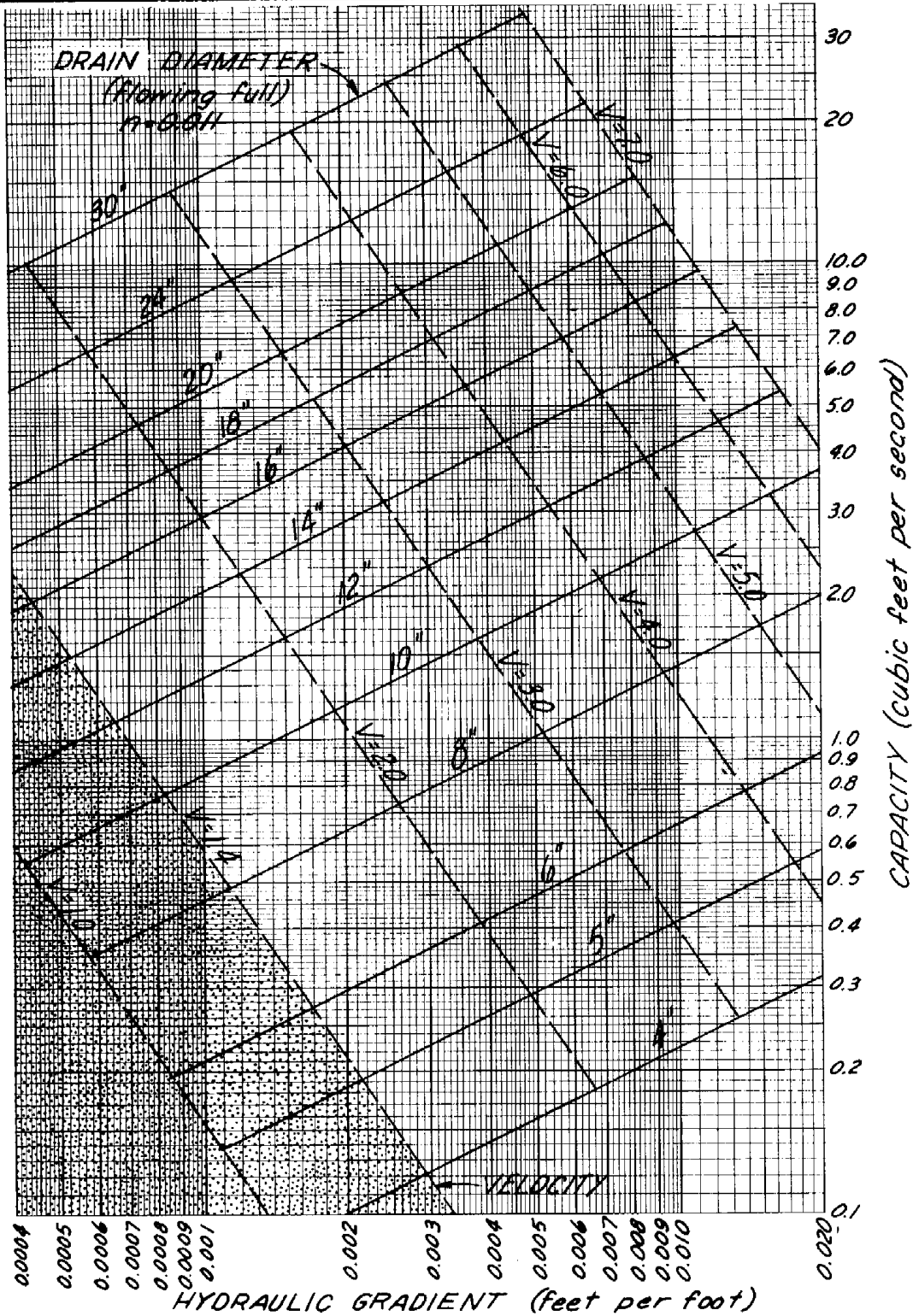

REFERENCE: This chart was developed by Guy B. Fasken.

U. S. DEPARTMENT OF AGRICULTURE
 SOIL CONSERVATION SERVICE
 ENGINEERING DIVISION - DRAINAGE SECTION

STANDARD DWG. NO.
 ES - 721
 SHEET 1 OF 3
 DATE 8-3-70

Figure 4-36, Capacity chart - $n = 0.011$

DRAIN CAPACITY CHART - n = 0.013

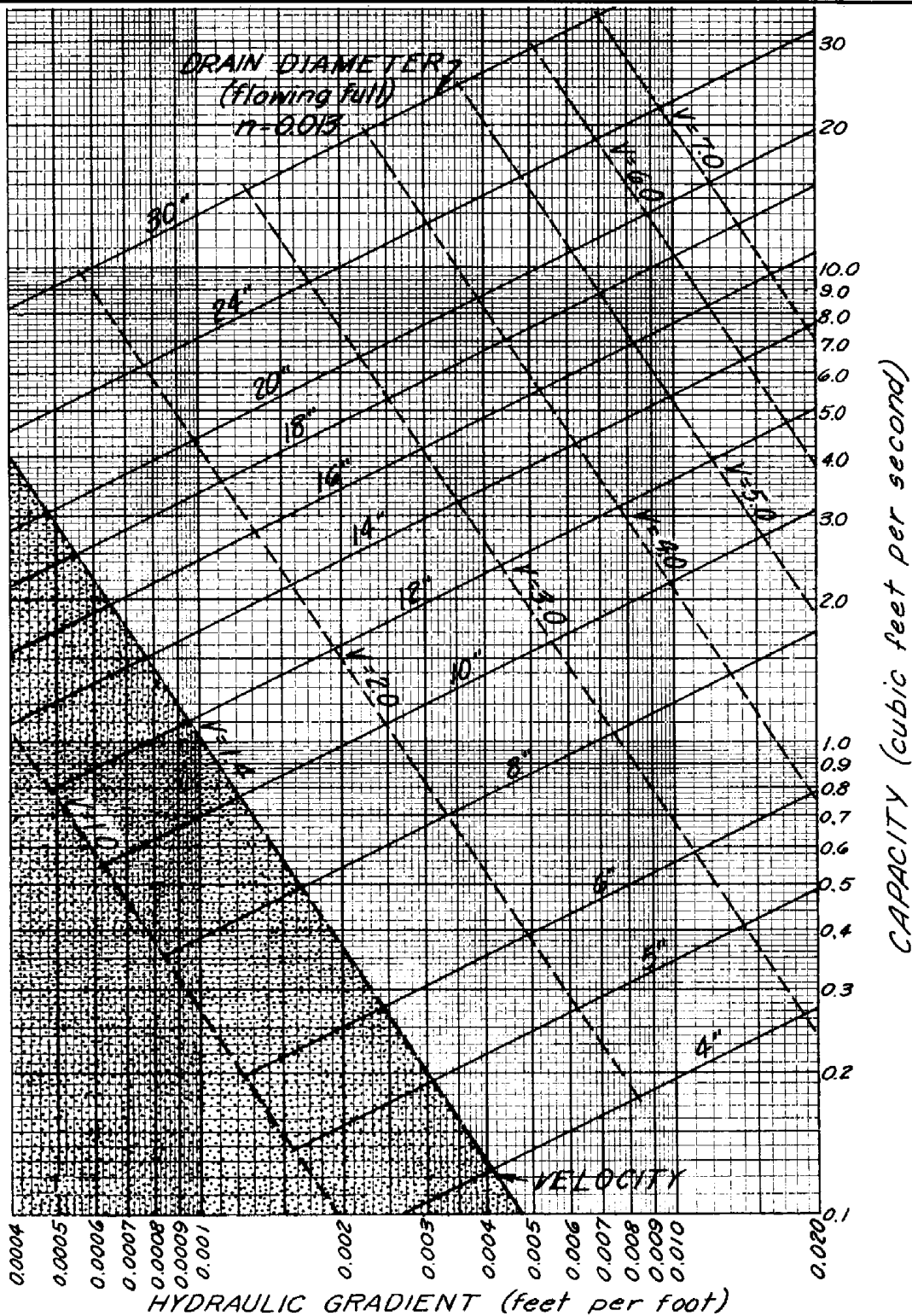

REFERENCE: This chart was developed by Guy B. Fasken.

U. S. DEPARTMENT OF AGRICULTURE
 SOIL CONSERVATION SERVICE
 ENGINEERING DIVISION - DRAINAGE SECTION

STANDARD DWG. NO.
 ES - 721
 SHEET 2 OF 3
 DATE 8-3-70

Figure 4-36, Capacity chart - n = 0.013

DRAIN CAPACITY CHART - $n = 0.015$

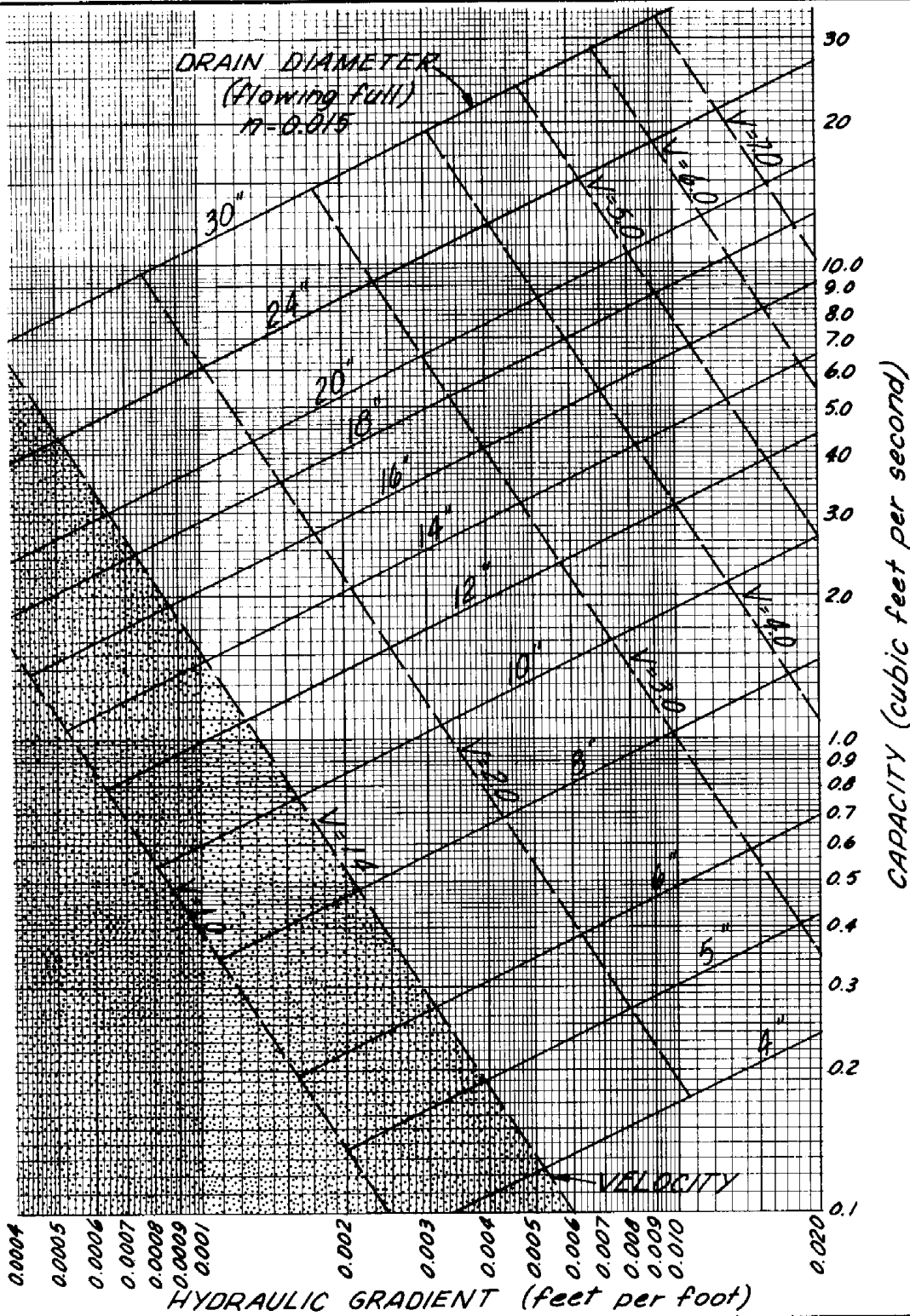

REFERENCE: This chart was developed by Guy B. Fasken.

U. S. DEPARTMENT OF AGRICULTURE
 SOIL CONSERVATION SERVICE
 ENGINEERING DIVISION - DRAINAGE SECTION

STANDARD DWG. NO.
 ES - 721
 SHEET 3 OF 3
 DATE 8-3-70

Figure 4-36, Capacity chart - $n = 0.015$

Sizing of drains within the drainage system

The previous discussion on drain size deals with the problem of selecting the proper size for a drain at a specific point in the drainage system. In drainage systems with long laterals or mains, the variation of flow within a single line may be great enough to warrant changing size in the line. This is often the case in long interception drains. The following example illustrates a method for making such a design.

Example:

Assume that the total discharge from 6,000 feet of interception drain was computed to be 2.40 cfs, that no surface water is admitted, and (with similar soils and subsoils) that the accretion to the drain is uniform throughout its length. Assume a constant grade of 0.20 percent. The accretion per 100 feet of drain would be $\frac{2.40}{60} = 0.04$ cfs. Use Figure 4-36 to determine the sizes of concrete or clay drain tile required. Start computation at the upper end of the drain using a minimum size of 6 inches. Compute the distance down drain that it would carry the flow on the assumed grade. Let (L) equal the distance (in 100-foot stations) down drain that a 6-inch drain would be adequate. Referring to Figure 4-36, a 6-inch drain on a grade of 0.20 percent has a maximum capacity of 0.31 cfs and:

$$L = \frac{0.31}{0.04} = 7.75 \text{--}100\text{-foot stations}$$

The 6-inch drain is adequate for 775 feet of line. Continuing these computations for the next size drain (8 inch) which has a maximum capacity of 0.65 cfs as follows:

$$L = \frac{0.65}{0.04} = 16.25 \text{--}100\text{-foot stations}$$

The 8-inch drain would be adequate for 1,625 feet. Of this 1,625 feet, it has already been determined that 775 feet would be 6-inch drain; therefore, the remaining 850 feet would be 8-inch drain. These computations should be continued progressively for the total length of the drain. The following tabulation shows the complete problem:

| Tile Size | Maximum Capacity .20% Grade | Accretion per 100' Line | L-Value Number of 100 Foot stations | Length of Tile Required |
|-----------|--------------------------------|-------------------------------|--|-------------------------------|
| inches | c.f.s. | c.f.s. | | feet |
| 6 | 0.31 | 0.040 | 7.75 | 775 |
| 8 | 0.65 | 0.040 | 16.25 | 850 |
| 10 | 1.30 | 0.040 | 32.50 | 1,625 |
| 12 | 1.90 | 0.040 | 47.50 | 1,500 |
| 14 | 2.90 | 0.040 | 72.50 | <u>1,250</u> ^{1/} |
| | | | | 6,000 |

^{1/} Total length of the drain is 6,000 feet, and although the 14-inch tile would be adequate for 7,250 feet, only 1,250 feet are needed.

The example assumes a single line with uniform accretion throughout its length. If investigations indicate a variation in permeability, the accretion rate per 100-foot station may be varied. If laterals enter the drain, the estimated yield of these should be added at the proper station. The example illustrated is for a single interception drain. The same procedure is applicable for mains in a relief system where laterals join at regular intervals. In this case the accretion to the main would be the accumulative discharges of each of the laterals at intervals equal to the drain spacing.

The size of drain for a main drain line can be found by determining the required capacity at various points along the main, and the size required for the capacity and grade at the point. The drainage area or the accretion at each break in the drain grade must be known. Usually the drainage coefficient for a system is the same for the entire system but in some cases the coefficient may vary and this must be considered in determining the drain size.

Materials for drains

General

For many years after subsurface drainage was first introduced in the United States most of the drains were made of ceramic tile. "Tile drain" became the most common term used to refer to a subsurface drain, and it is still used in many parts of the country to refer to subsurface drains manufactured from all kinds of materials.

Materials now commonly used for drains include ceramic tile, concrete, bituminized fiber, plastics, asbestos cement, aluminum alloy, and steel. Some of the products manufactured from these materials are made in such a way that drainage water will enter the conduit through the joint between adjacent sections of the drain, and some are made with perforations through which water enters the drain.

Factors involved in the selection of the drain to be used include: climatic conditions, chemical characteristics of the soil, depth requirements, and installation cost. In northern areas freezing and thawing conditions must be considered in selecting the drain. Where acids or sulfates exist in the soil or drainage water, drains that will resist these conditions must be selected. The method of installation and the depth requirements influence the selection of the type and strength of the drain. The drain must sustain the loads to which it will be subjected. The cost of the drain including the cost of transportation from the manufacturer to the place of installation is a big factor in selection of drains.

Standards and specifications

Specifications covering the physical requirements and testing methods for use in quality control of drains have been developed by several organizations and groups interested in standardization and maintenance of high quality for manufactured products. These include specifications and standards of the American Society for Testing and Materials (ASTM); Product Standards published by the National Bureau of Standards, U. S. Department of Commerce; and Federal Specifications of the Federal Supply Service, General Services Administration.

These specifications and standards are revised as necessary to reflect improved methods of manufacture, new materials, and changed requirements for use of the product. The latest revision, which is indicated by its date, should be used. Specifications for materials which are approved for use in installations for which the Soil Conservation Service is technically responsible are listed in current Engineering Practice Standards of the Soil Conservation Service.

Newly developed products, for which specifications are written by the manufacturer and approved by the Soil Conservation Service, may also be used pending development of standard specifications by one of the organizations listed above.

Clay drain tile

Clay tile may fail due to the freezing and thawing reversals in northern areas where frost penetrates the ground to the depth of the tile or where the tile is stockpiled on the ground during the winter before being installed. Damages due to such exposure may be serious. The absorption of water by tile is a good index of its resistance to freezing and thawing. Tile manufactured from shale usually has lower absorption rates and is more resistant to freezing and thawing than tile made from surface clays. The quality of clay tile is also dependent upon the manufacturing process. Many plants use de-airing equipment which increases the density of the extruded material. Generally color and salt glazing are not reliable indicators of the quality of tile. Clay tile are not affected by acids or sulfates. Low temperatures normally will not affect the use of clay tile provided the tile are properly selected for absorption and that care is taken in handling and storage of the tile during freezing weather.

Concrete drain tile

Concrete tile of high density are not affected by freezing and thawing reversals and freezing temperatures. It will be adversely affected, however, if exposed to the action of acids or sulfates unless the tile has been manufactured to meet these situations. Concrete tile is not recommended for extremely acid or sulfate conditions. Research (13, 14) by Dalton G. Miller and Phillip W. Manson has provided information on which guide lines have been adopted for the quality of concrete in drain tile for installation in acid and sulfate soils.

The following guide may be used for obtaining soil samples and tests for determining acid or sulfate concentration at the site for a tile installation:

1. Take samples where soil conditions indicate the probability of moderate to severe concentration of acids or sulfates in the soil.
2. Take each sample at the average depth of tile at the approximate location of tile line.
3. Take a minimum of three samples but not less than one sample for each 10 acres drained or 1,500 feet of tile.
4. Obtain the pH and sulfate test for each sample. Record individual test values. If the results of most severe acid or sulfate condition appear out of line, obtain additional samples and check results.

Recommendations for a particular type and quality of tile to meet certain conditions of acid or sulfate soils are based on the specifications for the particular type of tile. As these are subject to change, guidance for selection of a type or quality of tile for use under certain conditions may be obtained from engineering practice standards of the Soil Conservation Service.

Bituminized fiber pipe

Bituminized fiber pipe may have a homogeneous or laminated wall structure. The pipe comes in various lengths from 4 to 20 feet. The pipes are connected by tapered couplings to form a watertight joint, or with a sleeve coupling for butt joints. This pipe, without perforations, may be used to protect the outlet of drains of other material. However, the out-of-bank projection of bituminized fiber pipe must be kept short, not more than 3 to 4 diameters in

length to maintain its shape against softening and collapse by exposure to the heat of the sun. Precautions must also be taken against any point loading against the pipe walls by a stone or buried log which can cause failure by cold flow of the bituminous material.

Plastic drains

Various kinds of drains made from different types of plastics have been produced. Plastic drains are flexible conduits that will develop good load-bearing strengths if they are installed in a way which will insure that the drain will be supported by the soil around it as the drain deforms.

Plastics have been used to produce corrugated drains with relatively thin walls which have a high load-bearing strength when properly installed. The depth to which the corrugated plastic drains may be installed depends upon the width of the trench and the manner of bedding the drain.

Metal pipes and others

In drainage work metal pipe is used chiefly for the following purposes:

1. As outlets for tile and plastic drains.
2. As a substitute for other types of drains which do not have enough strength to withstand surface loads where sufficient cover of soil is impossible to obtain.
3. Under road crossings where additional load-bearing strength is required.
4. For auxiliary structures.
5. For installation through pockets of quicksand or similar unstable soils where a continuous pipe without joints is required.

Filters and envelopes

Filters for drains are permeable materials placed around the drains for the purpose of preventing fine-grained materials in the surrounding soils from being carried into the drain by ground water.

Envelopes for drains are permeable materials placed around the drains for the purposes of improving flow conditions in the area immediately surrounding the drain, and for improving bedding conditions.

Determination of need for filters and envelopes

In designing a drainage system one of the first considerations is to determine if a filter is needed. Referring to Table 4-7, it will be noted that soils are separated into three groups (Unified Classification System) according to the need for a filter. The first group always needs a filter. The second group may or may not need filters and the third group seldom needs filters except under unusual conditions.

Determination of the need for envelopes must be secondary to that for filters as filters often will serve the same purpose. The need for an envelope should be considered in those cases where a filter is not specified, and where flexible pipe is used for the drain. Referring to Table 4-7, it will be noted that envelopes may be used in all cases where filters are not recommended.

Table 4-7, The need for drain filters or envelopes

| A CLASSIFICATION TO DETERMINE THE NEED FOR DRAIN FILTERS OR ENVELOPES, AND MINIMUM VELOCITIES IN DRAINS | | | | |
|--|---|---|--|---|
| Unified Soil Classification | Soil Description | Filter Recommendation | Envelope Recommendation | Recommendations for Minimum Drain Velocity |
| SP (fine) SM (fine) ML MH | Poorly graded sands, gravelly sands. Silty sands, poorly graded sand-silt mixture. Inorganic silts and very fine sands, rock flour, silty or clayey fine sands with slight plasticity. Inorganic silts, micaceous or diatomaceous fine sandy or silty soils, elastic silts. | Filter needed | Not needed where sand and gravel filter is used but may be needed with flexible drain tubing and other type filters. | None |
| GP SC GM SM (coarse) | Poorly graded gravels, gravel-sand mixtures, little or no fines. Clayey sands, poorly graded sand-clay mixtures. Silty gravels, poorly graded gravel-sand silt mixtures. Silty sands, poorly graded sand-silt mixtures. | Subject to local on-site determination. | Not needed where sand and gravel filter is used but may be needed with flexible drain tubing and other type filters. | With filter - none. Without filter - 1.40 feet/second. |
| GC CL SP,GP(coarse) GW SW CH OL OH Pt | Clayey gravels, poorly graded gravel-sand-clay mixtures Inorganic clays of low to medium plasticity, gravelly clays, sandy clays, silty clays, lean clays. Same as SP & GP above. Well graded gravels, gravel-sand mixtures, little or no fines. Well graded sands, gravelly sands, little or no fines. Inorganic, fat clays Organic silts and organic silt-clays of low plasticity. Organic clays of medium to high plasticity. Peat | None | Optional. May be needed with flexible drain tubing. | None - for soils with little or no fines. 1.40 feet/second for soils with appreciable fines. |
| <p>REFERENCE: This chart was developed by William F. Long and Ralph Brownscombe.</p> <p>U. S. DEPARTMENT OF AGRICULTURE SOIL CONSERVATION SERVICE</p> <p>ENGINEERING DIVISION - DRAINAGE SECTION</p> <p>STANDARD DWG. NO ES - 722 SHEET 1 OF 1 DATE 8-3-70</p> | | | | |

Their need should be based on consideration of soil permeability and the bedding requirements of the drain.

The last column in Table 4-7 gives recommendations for the minimum velocity in drains to prevent sediment from being deposited in the drain. It will be noted that where filters are specified there is no recommendation for minimum velocity.

Materials for filters and envelopes

A material may have characteristics which meet the requirements of both a filter and an envelope for a particular site condition. Well graded sand-gravel materials often have these characteristics. Other materials, which may be less costly, may be suitable for only one purpose. It is necessary, therefore, to determine the requirements of a particular installation and specify a material which will meet the requirements.

The specifications for granular filter materials are more rigid than for envelope materials and often it is necessary that they be screened and graded to develop the desired gradation characteristics. Envelope materials usually are available in their natural state at low cost without processing. However, if the envelope material contains fine material which may enter the drain, or seal the joints, these fines should be screened out before using the material. Filter materials with the proper gradation are available in the natural state at some locations but frequently it is necessary to do some processing, which usually increases the cost materially. For this reason it is important that the requirement for sand and gravel filters or envelopes be clearly specified on all plans for buried drains.

In humid areas, where soils have a high content of organic material, it is a common practice to blind the drain with topsoil shaved from the top and sides of the trench. This topsoil often has a high permeability and serves as an envelope and a filter to some degree. Organic materials such as hay, straw, sawdust, wood chips, and ground corncobs also are used to some extent and are effective for a limited period of time. Organic matter should be kept away from the drain in those areas where soil contains iron or manganese compounds. Organic matter around the drain adds to the problem of chemical deposits clogging the soil immediately adjacent to the drain, the joints, and the perforations in the drain. Sand and gravel and fiber glass are used to a limited extent in humid areas for filters.

In arid areas soils generally are mineral soils with a low organic content and generally are not suitable as filter material. Blinding is practiced only to prevent displacement of the drain during backfill operations. Sand and gravel filters and envelopes are used extensively in the arid areas. Fiber-glass filters have been used to a very limited extent.

Organic filters and envelopes. - Of all the organic filter and envelope materials, organic soils are most commonly used. Organic soils used to blind the drain also serve as a partial filter. The exact filtering quality of organic soils is unknown and there is no feasible method of measuring this. From long experience it is known that drains blinded with good organic soils have a better record of performance than those without such blinding. This also is true for drains blinded with other organic materials such as hay, straw, sawdust, wood chips and corncobs. The relative filtering qualities of these materials varies with particle size gradation. The coarser materials such as wood chips and corncobs have a low filter value but do serve as an envelope to improve hydraulic conditions in the area surrounding

the drain. The use of these materials is not objectionable but there is some question as to their value under certain circumstances. The practice of blinding with organic topsoil is recommended except as noted above where there is a problem of chemical deposits around the drain. Blinding is essential to maintain drain alignment and the filtering effect obtained is a cost-free by-product of the blinding operation. In summary, it is recognized that organic filters and envelopes, as discussed above, have some value as a filter but the specific value is unknown and not measurable. For this reason drains in critical soils known to be subject to piping should be protected with other types of filter material with measurable and known qualities.

Fiber-glass filters. - Fiber-glass filters are manufactured from glass products and are commercially available in rolls for various size drain and trench width. There are currently several types of this material available, varying in thickness from paper thin to about 1 inch. Lime-borosilicate glass is the only type of glass suitable for use in underground filters.

Fiber-glass filters, or mats as they are often called, are a nonwoven fabric and the size of openings varies from point to point within the material. For this reason the size of particles that will pass through the filter are not uniform but have some gradation. Recommendations for use of a particular type of fiber-glass filter should be based on experience and available research.

Plastic-fabric filters. - Several new plastic fabrics have recently become commercially available as filter material. Polypropylene, polyvinylidene, and polyethylene filter material also are available. Although research and experience with these to date is limited the product data available indicate that they are useful as filters for drains.

Sand and gravel filters and envelopes. - Sand and gravel filters and envelopes are used extensively in arid areas with mineral soils of low organic content. Sands and gravels suitable for filter and envelope material are readily available in their natural state in many areas. Where pit-run sand and gravel are poorly graded and not suitable for filter material, it is necessary to process it prior to use. On large projects where a considerable volume of filter material is needed, it may be desirable to set up a local screening plant for this purpose. On small projects it usually is more economical to purchase the desired gradation of filter material from a commercial sand and gravel plant. Experience with all types of drain filters indicates that sand and gravel filters have performed the best. This type of filter should be given first consideration for use.

Design of filters and envelopes

Design of sand and gravel filter. - The first step in selecting an acceptable sand and gravel material for a filter is to determine, by mechanical analysis, the gradation curve of the base material. The base material is the soil found at the depth the drain is to be laid. Samples of the base material should be obtained and a mechanical analysis made. The number of samples taken depends on variations in the base material. The following design criteria are based on research by the U. S. Bureau of Reclamation and the Corps of Engineers, U. S. Army. Limits are established which should be met by a filter material for a specific base material. Multiplying the 50-percent grain size of the base soil material by 12 and 58 will give the limits the 50-percent size of the filter should fall within. Multiplying the 15-percent fine size of the base soil material by 12 and 40 gives the limits the 15-percent fine size of the filter should fall within. The gradation curve of the filter material should generally parallel that of the base material. All of the filter

material shall pass the 1 1/2-inch sieve, 90 percent of the material shall pass the 3/4-inch sieve and not more than 10 percent of this material shall pass the No. 60 sieve. The maximum size limitation insures against damage to drains or alignment or too much segregation during placement, and the No. 60 sieve limitation prevents an excess of fines in the filter, which are more easily carried by water percolating into the drain. These limits are summarized as follows:

$$\frac{\text{50-percent size of filter}}{\text{50-percent size of base}} = 12 \text{ to } 58$$

$$\frac{\text{15-percent fine size filter}}{\text{15-percent fine size base}} = 12 \text{ to } 40$$

Where the filter and base material are more or less uniformly graded, a filter stability ratio of less than 5 is generally safe, thus

$$\frac{\text{15-percent fine size filter}}{\text{85-percent fine size base}} = \text{less than } 5.$$

Figure 4-37 illustrates the use of the criteria where three filter materials have been graded to determine their suitability.

In locations where sand-gravel filters are commonly used, it is recommended that gravel pits be selected, mechanical analyses made, and the gradation and limiting curves prepared for each pit. A filter guide may be established by preparing gradation curves of base material, and by comparison with the pit curves, the most desirable pit material can be selected. For routine agricultural-drainage installations, many pit-run gravels are adequately graded to do a reasonably good job of filtering; but sample analyses should be made.

Where sand and gravel filter material is to be placed around perforated drains, consideration must be given to the diameter of the perforations as these are fixed and cannot be varied as the gap-space can in the case of butt-end tile. Where perforated drains are used, the D_{85} (85% fine line) size should be no smaller than one-half the diameter of the perforations and no more than 10 percent of the filter material should pass the No. 60 sieve.

Where sand and gravel filters are used, the thickness of the filter material around the drain should be 3 inches or more. In those cases where the top of the drain is covered with a plastic strip, the requirement for filter above the drain may be waived. This design will reduce the amount of filter material required and may be the most economical in areas where sand and gravel are expensive. Experience to date indicates that this is the best type of filter installation (Figure 4-38).

Design of fiber-glass filters. - All fiber-glass filter material must be fabricated from lime-borosilicate type glass. Experience with other types of glass has indicated that they are not suitable for use underground. Fiber-glass filter material is commercially available in several degrees of thickness, all of which have been used with varying degrees of success. As a general practice, these filters are placed over the top two-thirds of the circumference of the drain; however, in some cases the material has been placed completely around the drain. The use of fiber-glass filters for drains is rather new and at present there is not sufficient experience to indicate the expected life and durability of the material.

State _____ Area _____ District _____
 Property John Jones
 Location T.13S., R.10E., SW 1/4 Sec. 8 Date 4-9-70
 Base Soil Sample: No. 1 4 to 6 Feet No. 2 _____
 Proposed Filters { No. 1 McGregor Pit
 No. 2 Wilson Pit
 No. 3 Jacob Pit

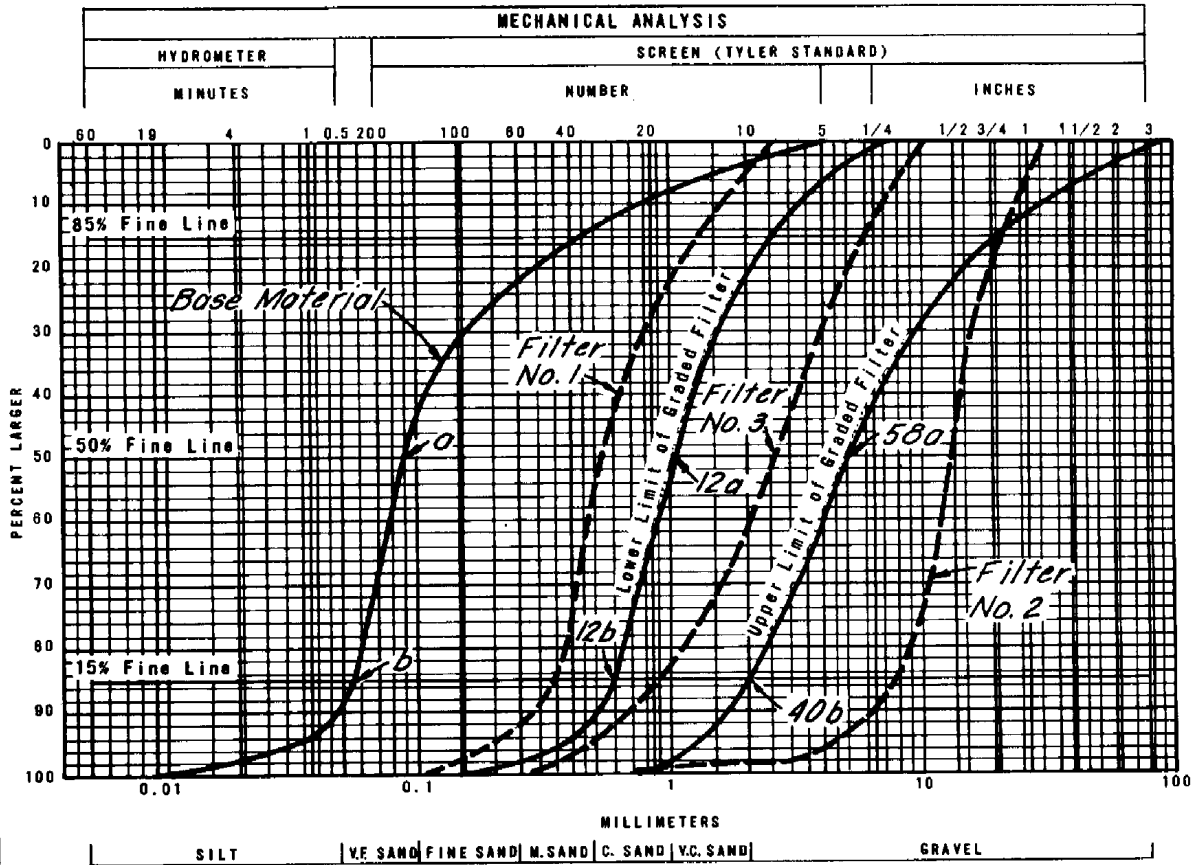

| MECH. ANALYSIS | BASE NO. 1 | | BASE NO. 2 | | FILTER NO. 1 | | FILTER NO. 2 | | FILTER NO. 3 | | |
|----------------|------------|------|------------|------|--------------|------|--------------|------|--------------|------|-----|
| | Ret. | Acc. | Ret. | Acc. | Ret. | Acc. | Ret. | Acc. | Ret. | Acc. | |
| SIEVE | 1 1/2 | | | | | | 0 | 0 | | | |
| | 1 | | | | | | 2 | 2 | | | |
| | 1/2 | | | | | | 44 | 46 | 0 | 0 | |
| | 1/4 | 0 | 0 | | | | 44 | 90 | 10 | 10 | |
| | 5 | 1 | 1 | | | 0 | 0 | 9 | 99 | 18 | 28 |
| | 10 | 2 | 3 | | | 3 | 3 | 0 | 99 | 36 | 64 |
| | 20 | 7 | 10 | | | 23 | 26 | 0 | 99 | 23 | 87 |
| | 40 | 6 | 16 | | | 44 | 70 | 1 | 100 | 10 | 97 |
| | 60 | 6 | 22 | | | 24 | 94 | | | 2 | 99 |
| | 100 | 8 | 30 | | | 4 | 98 | | | 1 | 100 |
| HYDROMETER | 200 | 34 | 64 | | | 2 | 100 | | | | |
| | 0.5 | 23 | 87 | | | | | | | | |
| | 1 | 5 | 92 | | | | | | | | |
| | 4 | 4 | 96 | | | | | | | | |
| | 18 | 4 | 100 | | | | | | | | |

Notes:
Filter No. 3 fits
the base material
curve better than
1 or 2 and should
be specified as 1
and 2 do not fall
within the 15 and
50 % bracket

Recommended
 Filter No. 3

Figure 4-37, Mechanical analyses of gravel filter material

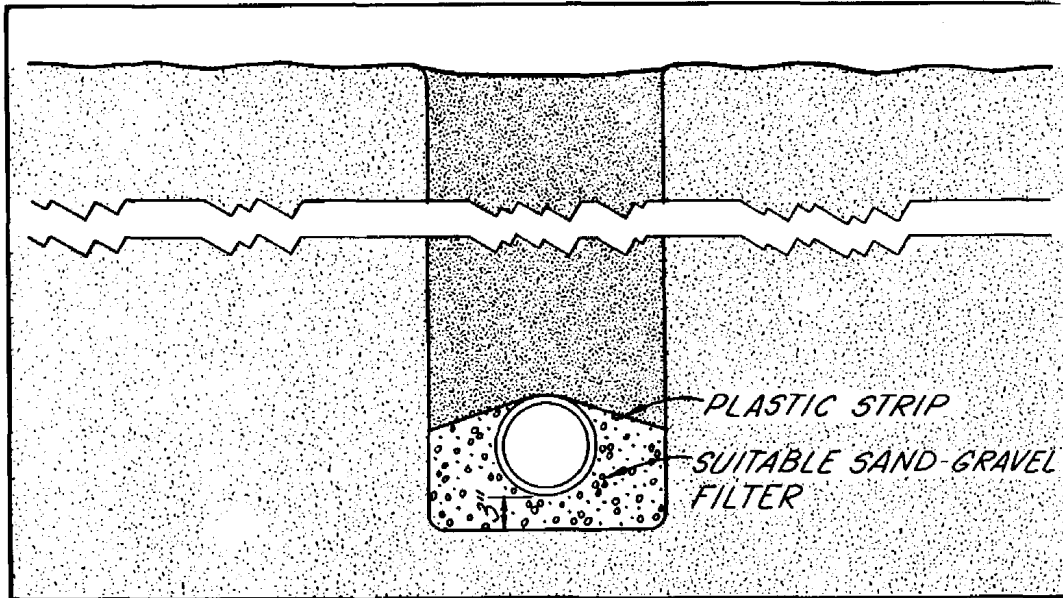

Figure 4-38, Filter installation

Design of organic filters. - Organic filters cover a wide range of materials from organic soils to sawdust and wood chips. The conditions and the results obtained over the country as a whole are so varied and different that it is impossible to discuss them in a limited space. Reference is made to state and local guides and handbooks.

Organic filters are usually thicker than other types. In general they vary from about 6 inches to 1 foot. The information on effectiveness must be based largely on local experience as there are no established methods to determine the filtering action of these materials in advance of design and construction.

Design of sand and gravel envelopes. - One of the basic functions of an envelope is to improve the permeability in the zone around the tile. For this reason the first requirement is that the envelope material have a permeability higher than the base material. All of the envelope material should pass the 1 1/2-inch sieve, 90 percent of the material should pass the 3/4-inch sieve, and not more than 10 percent of the material should pass the No. 60 sieve. The gradation of the envelope material is not important as it does not serve the purpose of a filter. The thickness of the envelope material surrounding the drain should not be less than 3 inches to insure complete placement. Amounts in excess of this are not objectionable but the economic feasibility is questionable.

In the case of interception drains on steep slopes, it may be desirable to place additional envelope material above the drain to prevent bridging-over of ground-water flow above the drain. Very little research information is available on this subject; however, indications are that this may occur where the hydraulic gradient of the water table exceeds 3 percent.

Drain appurtenances

Outlet structures. - When surface water must enter the ditch at the drain outlet, a structure should be used to discharge it into the ditch without erosion and to provide protection for the outlet of the drain. (Figure 4-39).

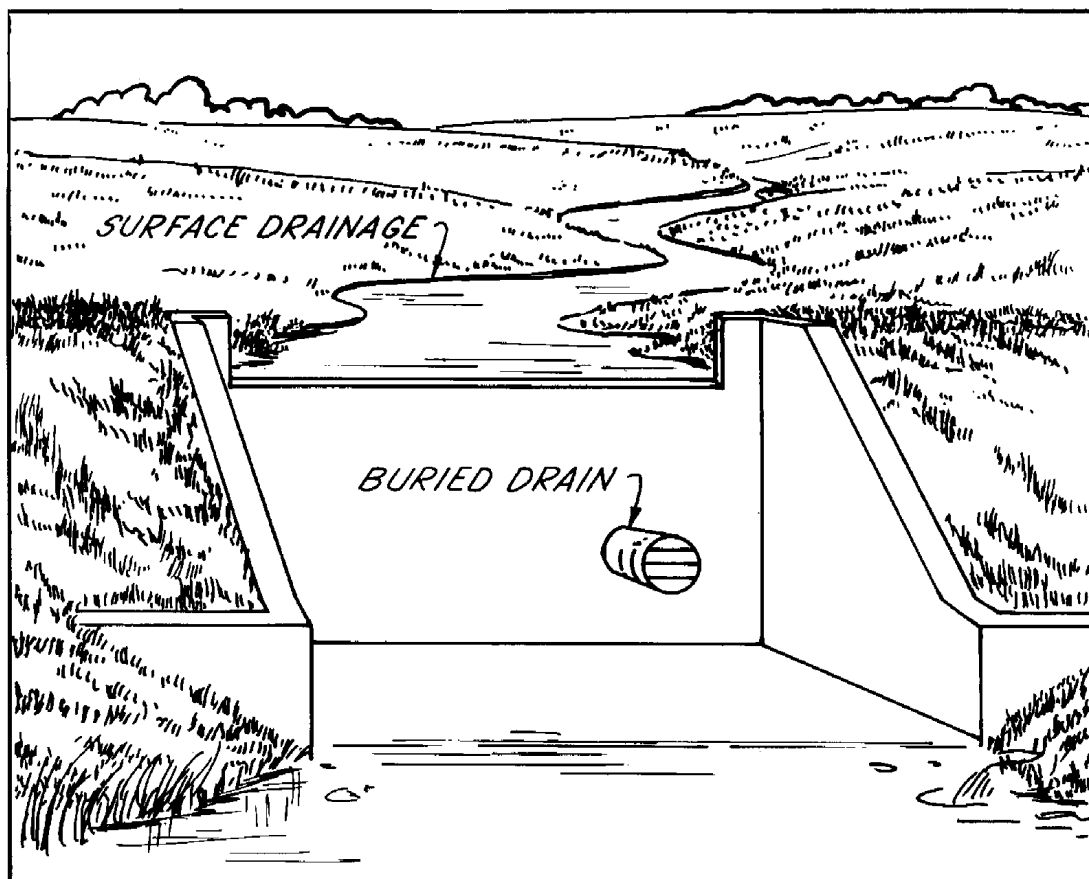

Figure 4-39, Outlet protection

When surface water is not involved, the most practical and economical outlet is a length of continuous pipe without perforations or open joints. The pipe should be sufficiently long to insure that there will be no seepage around the drain which may cause erosion at the outlet. At least two-thirds of the pipe should be embedded in the bank to provide the required cantilever support. An outlet into a recessed area off the ditch minimizes turbulence and provides protection from bank erosion, floating ice, and debris. When sufficient depth of cover is not obtainable at the drain outlet several methods may be used to protect the drain. (Figure 4-40).

Protection from animals. - Automatic flap gates, rods, or similar protection should be used on all drain outlets to exclude small animals unless the outlet is so located that it would be impossible for them to enter the drain. (Figure 4-41). No fixed bar or other type grating shown in this figure should be used where direct entry of surface water or any type debris is possible. Gates should be used in these cases.

Junction boxes. - Junction boxes should be used where more than two main drains join or where two or more laterals or mains join at different elevations. Where possible, junction boxes should be located away from farm traffic. The cover may be above ground so it can be seen and provide easy access for inspection. If the junction point is in a cultivated field, the top of the box should be set at least 18 inches below the surface of the ground, capped, covered with soil, and its location referenced so that it can be found easily. (Figure 4-42).

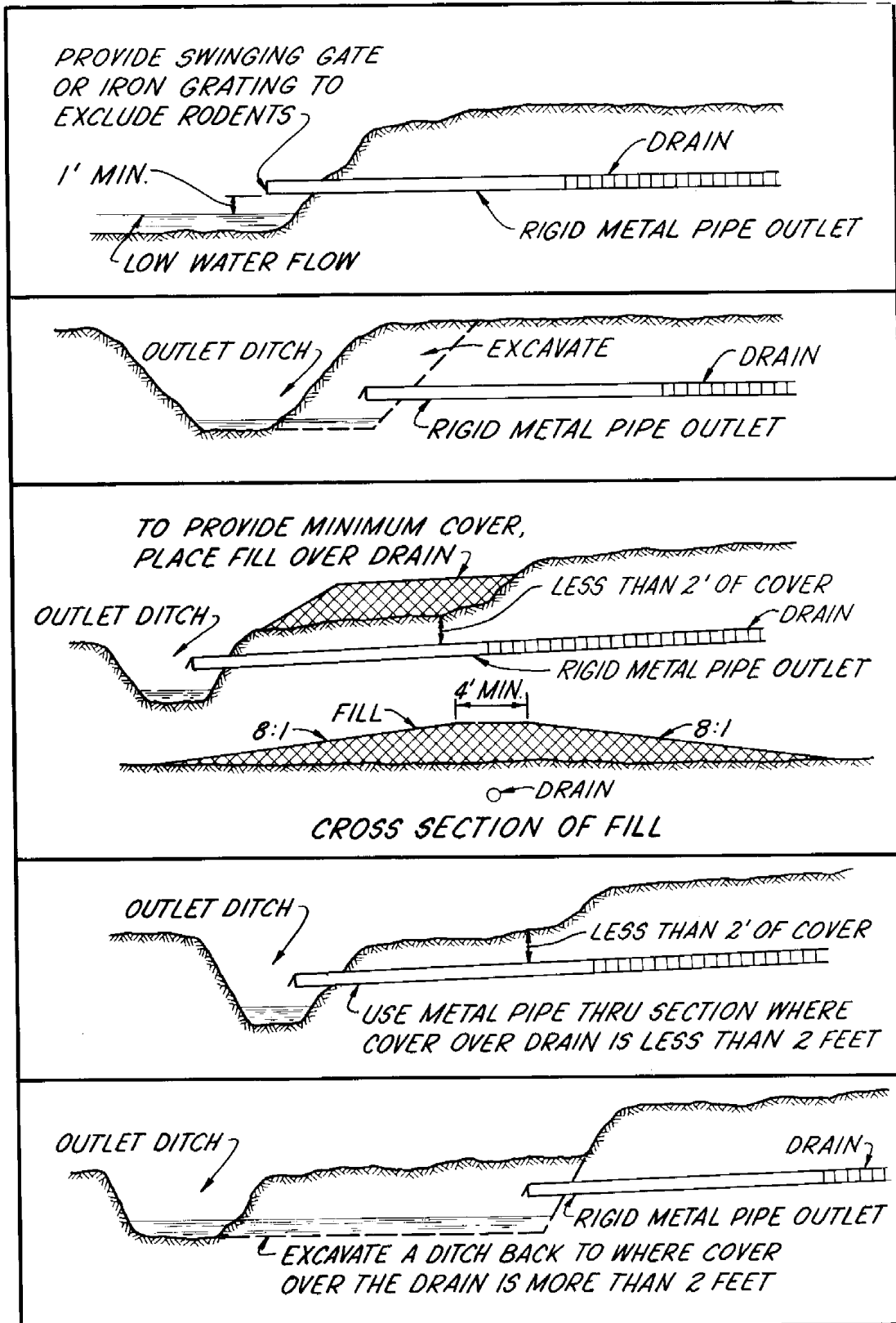

Figure 4-40, Drain outlets

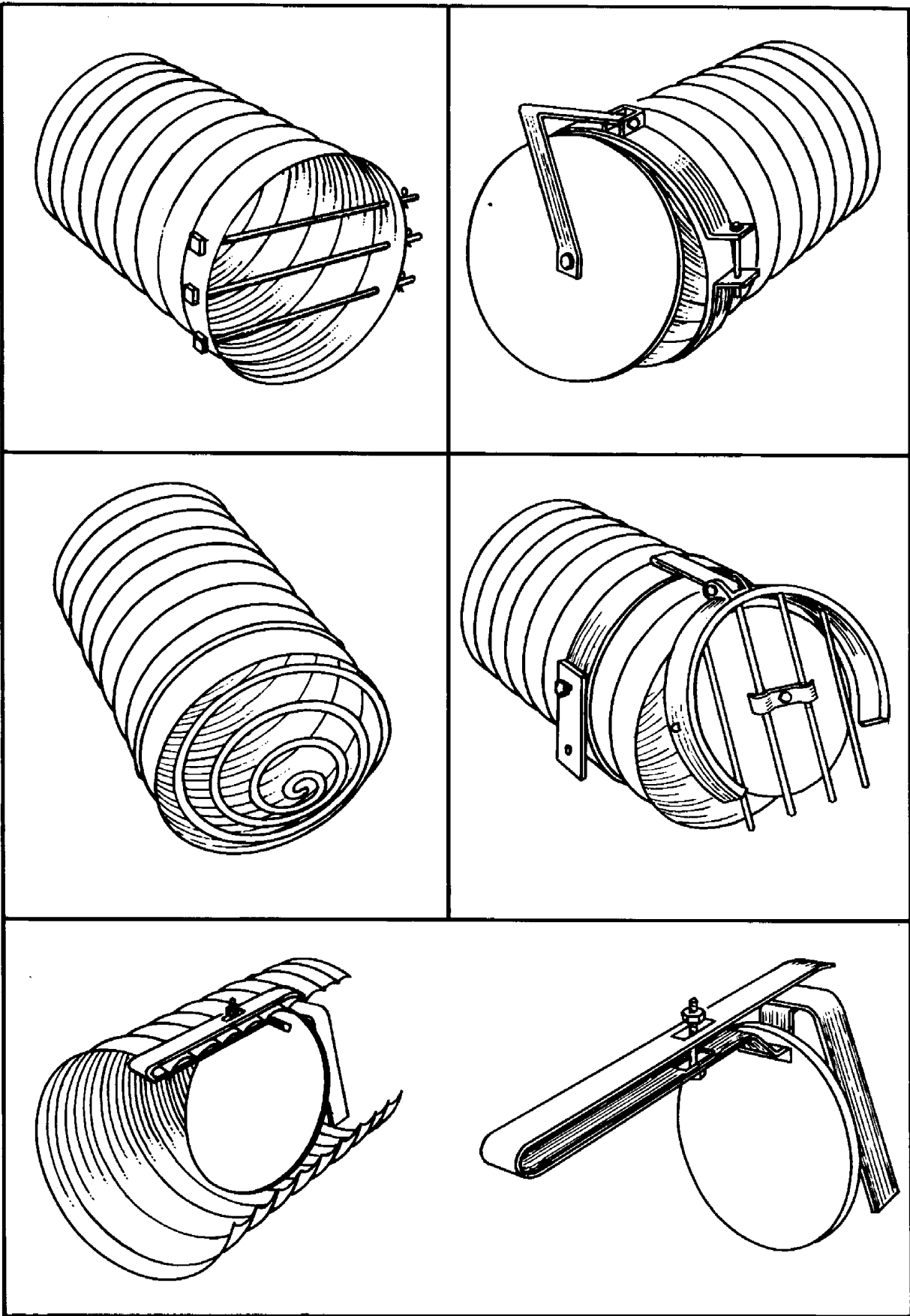

Figure 4-41, Rodent protection for outlet pipe

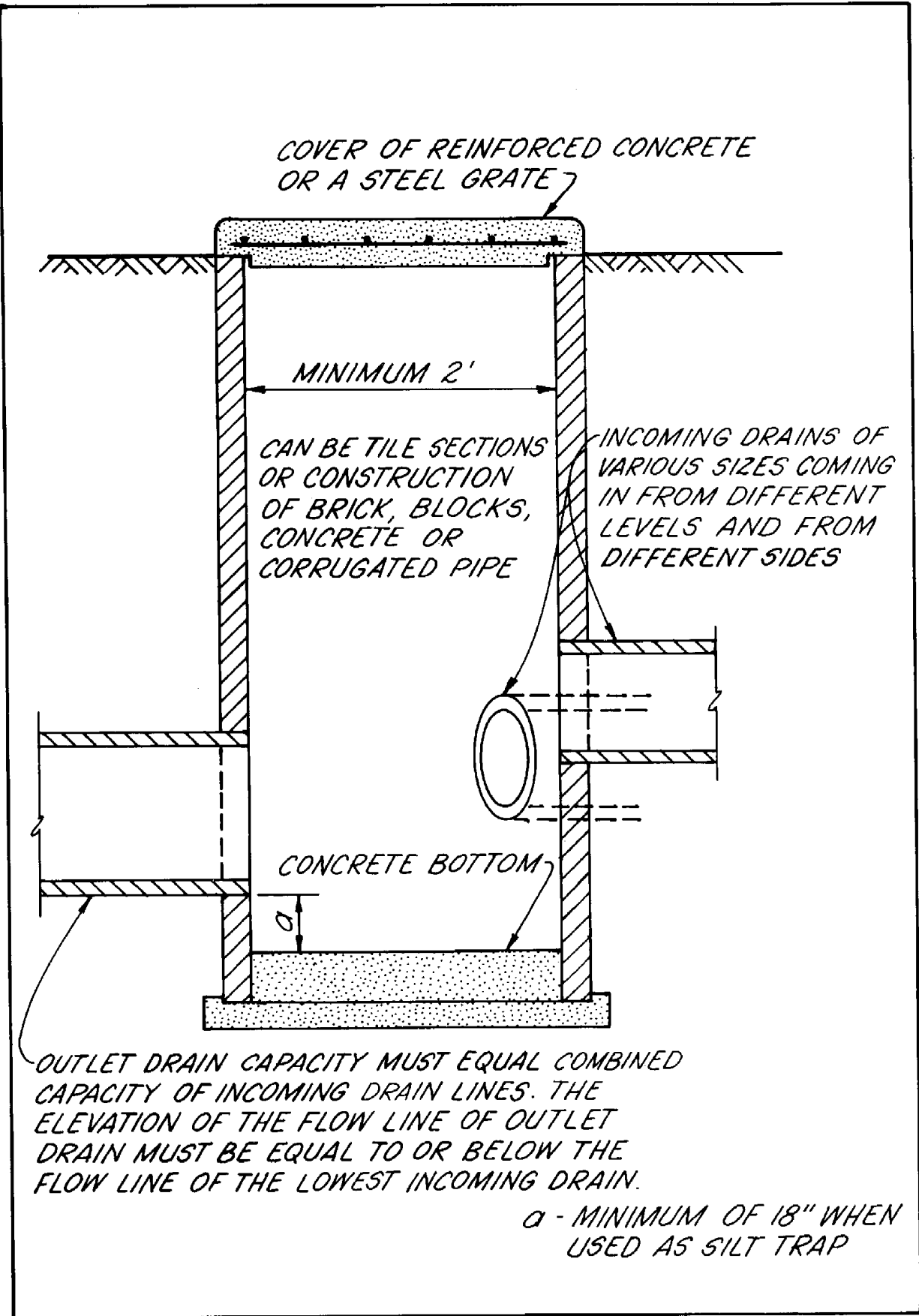

Figure 4-42, Junction box for drains

Pressure relief vent. - Vents serve to relieve pressure in the line that might otherwise cause erosion of the soil over the drain. This erosion results in holes which are known as "blowouts". These vents can be constructed by placing a T-connection in the line and cementing pipe vertically into the T. The relief pipe should extend at least 1 foot above the ground unless the design provides for it to serve also as a surface inlet. (Figure 4-43).

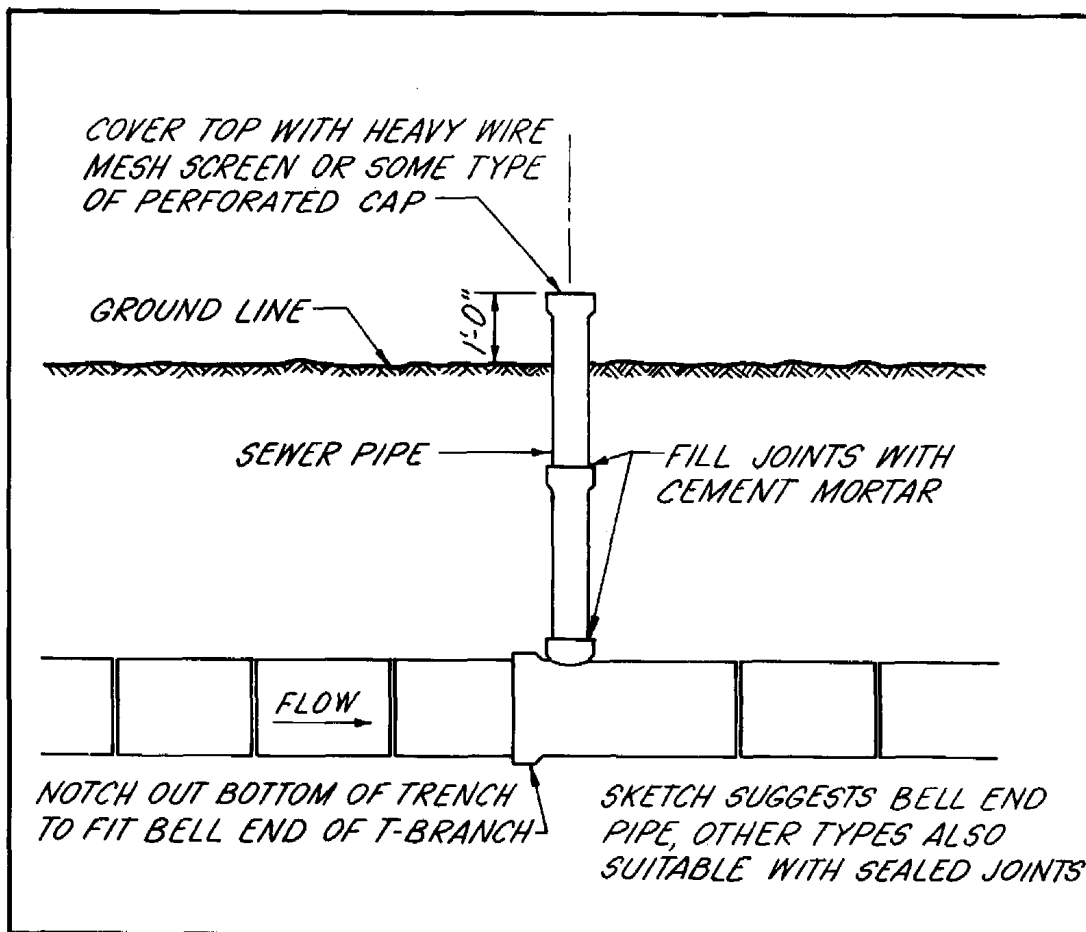

Figure 4-43, Vent

The exposed end of the pipe should be covered with heavy wire mesh or grating and firmly fixed to the pipe. The size of the riser pipe may be equal to or smaller in diameter than the drain. The illustration shows the use of sewer pipe to construct a vent. Other pipe such as concrete, bituminized fiber, or metal pipe may be used.

Vents should be located at points where the drain grade changes from a steep grade to a flat grade to eliminate the possibility of building up excessive pressures. Although the change in drain size is made at the break in grade to take care of the change in velocity, a vent will act as a safety valve and give added protection to these points. It is recommended that pressure relief vents be installed where the difference in grades exceeds 0.5 percent. Pressure relief vents will serve as breathers or inspection wells.

Breathers. - These are constructed the same as a vent and may serve the same purposes. A breather provides air entry to a drain for the purpose of venting the line.

Surface water inlets. - Surface water inlets are used to provide surface water an entry into a drain. Due to the high cost of carrying surface water in buried drains, this practice should be recommended only for draining low areas where a surface drainage system is not feasible or practical. When surface water inlets are used, two or three lengths of sewer pipe should be placed on each side of the riser. The riser should be installed as recommended for relief wells. Surface water inlets should be protected with a beehive or truncate of cone grate. (Figure 4-44).

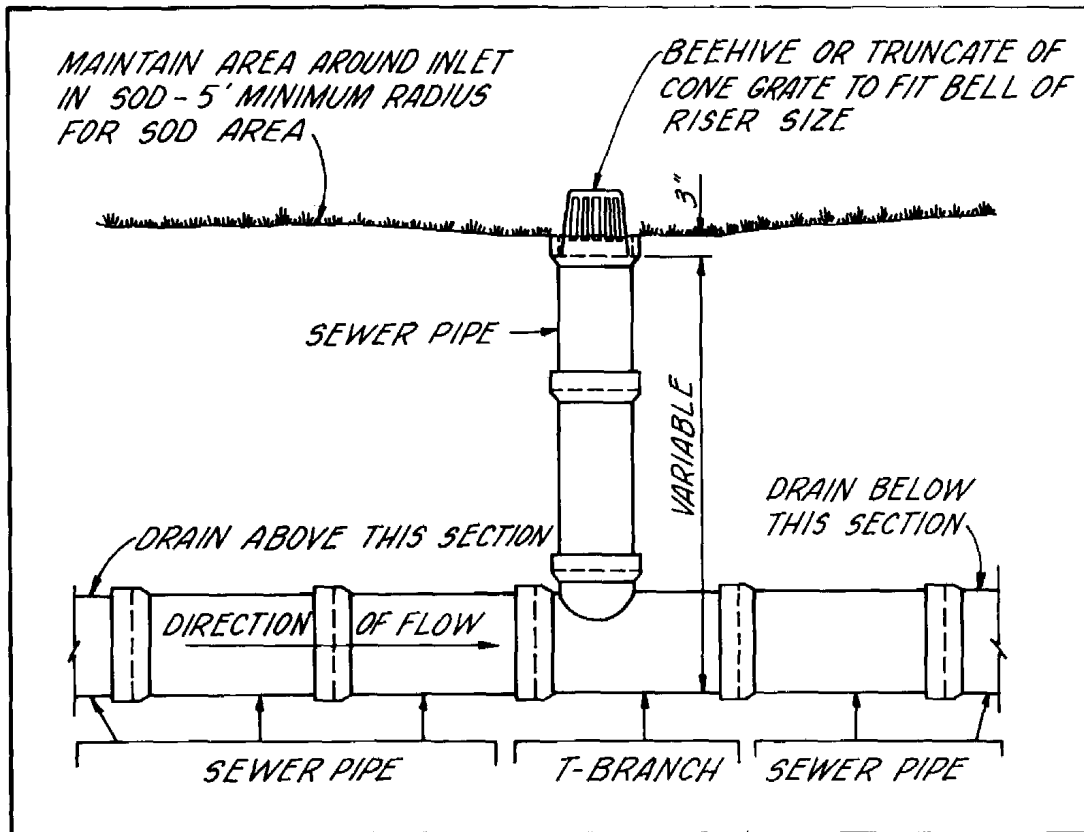

Figure 4-44, Surface water inlet

The cone grate is a desirable protection since it tends to float the flood debris and prevents the debris from closing over the entrance. Metal pipes with holes punched through the pipe at or slightly above ground level may be used as inlets. In some locations a top cover over the pipe prevents debris going down the pipe and a trash screen prevents lodging against the pipe.

Where there is a likelihood of substantial amounts of sediment entering the surface water inlet, it is advisable to use a manhole catch basin and sediment trap. (Figure 4-45). Since surface water inlets may be a source of weakness in a drainage system, offsetting the inlet to one side of the line reduces the hazard to the main line. One method of doing this is to place the surface water inlet on a short lateral so that damages which might occur to the inlet will not disturb the main.

Blind inlet or french drain. - A method of constructing a blind inlet is as follows: A section of the trench above the drain is filled with broken brick or tile, stone, gravel, or crushed rock, or a combination of these materials. The fill should be carefully selected and placed around and about 6 inches

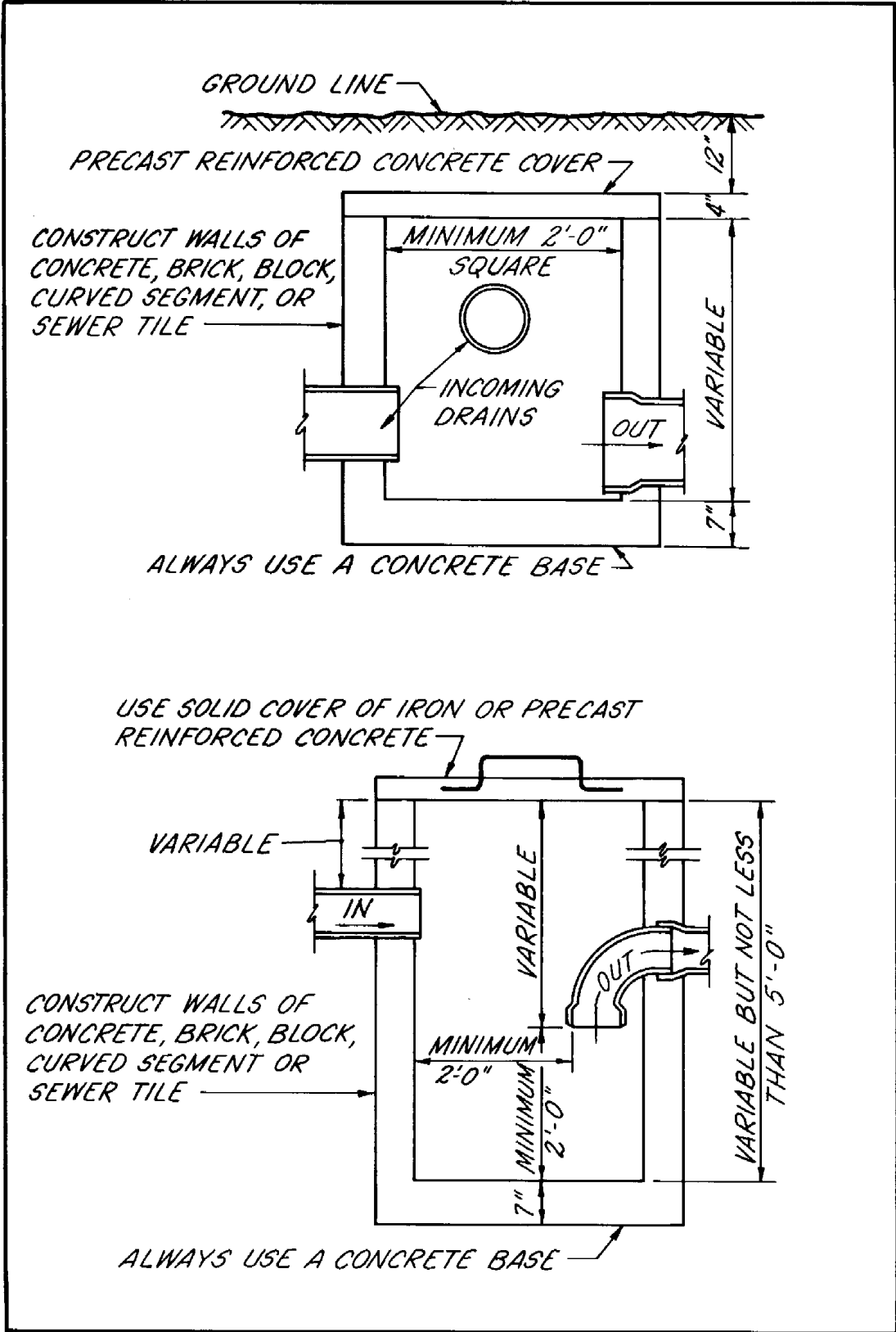

Figure 4-45, Manhole catch basin or sediment trap

above the drain to meet envelope requirements. Above this point up to within 12 or 18 inches of the ground surface, the material should be graded upward from coarse to fine and covered with topsoil. For faster intake of water and in areas where silting is a problem, pea gravel, small stones, or coarse sand may be used in place of the topsoil. Graded gravel also may be used to construct the blind inlet. The length of time for which the blind inlet will be useful depends on proper installation, fill material, and amount of sediment reaching the inlet.

Blind inlets are used to remove both surface and subsurface water and are most useful in open fields as they do not hinder farming operations. The rate of removal of impounded water through blind inlets is much slower than through surface inlets and should not be used where there is a large amount of impounded water.

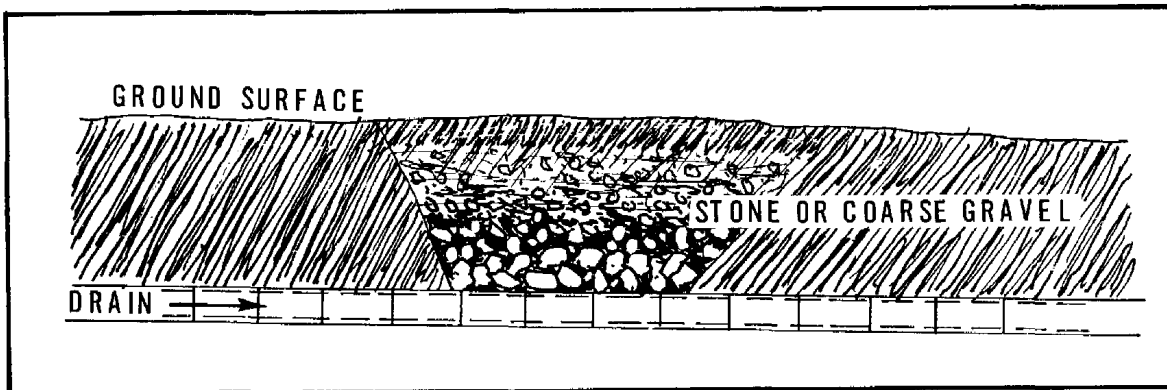

Figure 4-46, Blind inlet

Multiple drains in depressional areas. - Closely spaced multiple drains are occasionally installed in depressional areas to remove both surface and subsurface water. This type of installation (Figure 4-47) is easier to install than the blind inlet and is usually just as effective. Gravel envelopes will improve infiltration into these multiple lines.

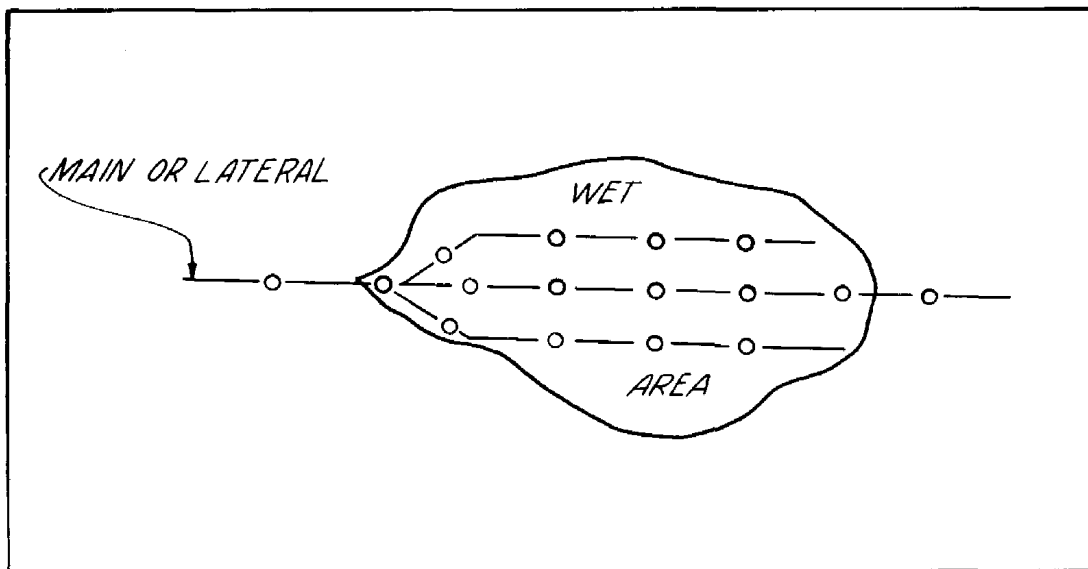

Figure 4-47, Closely spaced drains in wet areas

Drain crossings. - Special precautions should be taken where drains are placed under waterways, ditches, roads, or other crossings. If the cover is 30 inches or less or if unusual soil or load conditions exist, the drain should either be encased in concrete or a special pipe used such as metal or extra strength sewer tile with cemented joints. (Figure 4-48).

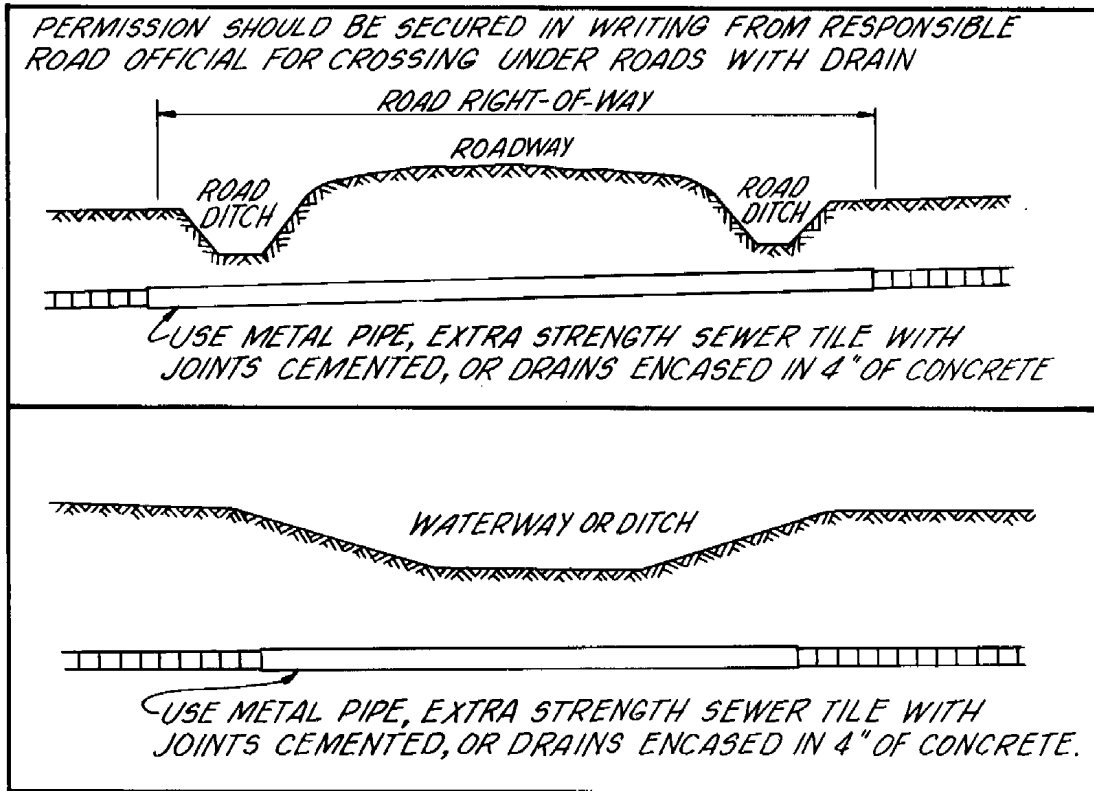

Figure 4-48, Drain crossings

Construction

General

Hand trenching is very seldom practiced except where trenching machinery is not available or where machine operation is impractical due to the small size or location of the proposed project. Both hand and machine trenching are discussed.

Drain installation by hand

The trench is usually staked at 25- to 50-foot intervals. Hubs are offset a short distance from the centerline of the trench and driven to about the ground level. A guard stake is driven near the hub on which is marked the station and the depth of cut from the top of the hub to the trench bottom.

Batter boards

Batter boards are used to assist the tiler to stay on grade. Batter boards are constructed by driving a stake at the hub and one on the opposite side of the proposed trench from the hub. Select a convenient depth (5 to 6 feet) and clamp or nail a horizontal crossbar on the two stakes at an elevation such that the top of the crossbar is the distance selected above the trench bottom. If 6 feet is selected and the cut on the hub is 3.9 feet, the top of the crossbar should be placed 2.1 feet above the top of the hub.



Trenching with a spade

Crossbars are set in the same manner at each hub. A chalk line or wire stretched over the top of the bars shows the slope of the proposed trench bottom. The chalk line should be straight if it does not include a grade break. The trencher can then measure from the chalk line to the bottom of the excavation to see if the trench is on grade. If three batter boards are set, the grade may be checked by sighting over the crossbars. When a grade break occurs, a target must be set at the station where the break is to be made and additional targets set beyond this point to obtain the correct slope of the line of sight.

Equipment used for trenching

Most excavation is done with a tile spade. In heavy, wet, or loose soil the solid tile spade is used, but sometimes a skeleton blade is much easier as it is lighter and the soils fall from it easier. A round-pointed shovel is used to clean out the trench if a drain cleaner is not available. A chalk line or wire of more than 100 feet in length, a rule, and other hand tools may be necessary.

Excavating the trench

Trenching begins at the outlet and proceeds upslope. Two or three spadings may be necessary, the number depends upon the depth of the trench. A trench width of 12 inches is sufficient for 4-, 5-, and 6-inch drains. Careful excavation of the top spading will prevent alignment difficulties later as line and width of the trench are established by the first spading. An accurate line should be stretched between the stakes to insure good alignment. The trencher faces the outlet and casts the first spading well back from the edge of the trench to provide space for the other spadings so the soil will not roll back into the trench. He may cast the excavation on either or both sides of the trench.

The last spading should be to a depth about 2 inches above the finish grade of the trench. The last few inches of the soil should then be removed from the trench by a drain cleaner or round-pointed shovel. The bottom of the trench should be shaped so that about one-fourth of the circumference of the drain will be in contact with the soil. Care must be taken to smooth the trench bottom to the exact grade. If a section of the trench is accidentally excavated below grade, the section should be backfilled, tamped, and shaped to grade. If unstable soil is encountered, the bottom of the trench should be firmed up with stable soil, hay, straw, sod, gravel, or other material. Sometimes it is necessary to cradle the tile by the use of boards using the rail and cleat method of forming the cradle.

Laying drains

The drains may be placed by the use of a hook or by hand. If the drains are slightly warped, they should be turned so they fit tight at the top. Care should be taken to see that the drains are placed in good alignment and that the proper gap recommended in the plan is maintained. Kicking the drain in place may result in too small a gap. Placing the drain with the hook will usually insure more uniform gapping. If a curve in the line is too sharp to lay the drain without causing a wide gap, the drain may be chipped so that it will have the intended gap. A monkey wrench or cutters may be used for this purpose. Junctions of lines are usually formed by manufactured fittings and cutting and concreting the junction is usually not necessary. "Y" fittings are ordinarily recommended. Research has shown that a junction at any reasonable angle will not materially retard flow.

Blinding drains

As soon as the drains are placed and inspected, they should be secured in place by putting friable soil around them and then blinding them with topsoil to a depth of 12 inches to preserve the alignment. Filters should be placed before the blinding is done, provided filter material is to be used. On steep grades or where the topsoil contains very fine sand, use heavier soil from the sides of the trench in blinding.

Backfilling the trench

Backfilling the trench should be done at the end of each day's work to eliminate the possibility of damage from surface water if heavy rainfall should occur. The end of the drain should always be blocked at the end of each day's work to prevent the entrance of silt and debris. The backfilling of a hand installation is frequently done by mechanical means.

Drain installation by machine

Most drain installation is done with trenching machines which have a sighting bar to keep the cutting shoe on grade when excavating the trench. The location and elevation of the sighting bar varies on different machines. The sighting bar may be on either side of the machine and from 2.5 to 5.0 feet to one side of the cutting shoe or buckets. For this reason it is necessary to know the type of machine that is to be used so the stakes can be located properly. Agreement should be reached with the excavating contractor as to the way the construction stakes will be set in order to prevent confusion.

Staking the drain

Staking the drain is started by placing the beginning or the 0+00 station near the outlet end of the line. This may be at the end of the outlet pipe. Hubs should be offset the proper amount and to the correct side of the centerline of the planned trench. They should be set every 100 feet or less and at all changes in grade or direction of the line. A minimum of three stakes is required to sight a grade. In case of a short tangent or change in grade, it may be necessary to set hubs on the extended tangent or extended grade in order to provide three sighting stakes. It is good practice to set hubs at control locations, such as maximum cuts, underground conduits, center of ditches, etc. Under normal conditions hubs are set on long curves but the machine operator will usually take care of the short curves by sighting across to the next tangent.



Setting targets for a trenching machine

The hubs should be driven on the required offset from the trench with sufficient accuracy so that when the targets are set they will line up. The targets generally used are a metal rod upon which is attached an adjustable cross bar painted a bright red. The machine operator usually sets the targets. He presses the rod into the ground at the stake and then adjusts the cross bar to a fixed distance above the grade of the trench.

The elevation of the hubs should be taken to the nearest 0.01 foot and the cut marked on each witness stake. The cut at a point is the difference between the elevation of the hub and the planned grade elevation at that point. Cuts are usually marked in feet and tenths of feet but some operators prefer to have the cut given in feet and inches. Cut sheets should be prepared in duplicate and show stationing, hub elevation, grade elevation and the difference which is the cut that is marked on the stake. The sheet should show the grade and size of drain. Special notes may be put on the sheet to describe any unusual condition such as soils, depth of cuts, underground conduits and any special protection required for the drain.

The cross bars of the targets are set so that the cut shown on the hub plus the distance which the top of the cross bar is set above the hub will equal the distance between the machine-sighting bar and the toe of the cutting shoe. The top of the cross bars of the targets should all line up for a particular grade as they are on the same slope as the proposed trench. If the cross bars do not line up when sighting over them, an error has been made in calculating the cut, setting the target or perhaps in the elevation of the hub. It is good practice to set the targets well ahead of the trenching machine so that a visual check of the grades can be made before excavating. In excavating, the operator keeps the sighting bar on his machine in the same plane as the targets.

Trenching machines

Drain installation may be done by several types of trenching machines but the two most common types employed by contractors are the bucket-wheel type and the bucket-ladder type. The bucket-wheel type of trencher has a large wheel mounted on a frame at the rear of the machine. The wheel can be moved up and down by power to keep the machine on grade. Attached to the wheel are excavating buckets. Just behind the buckets is a cutting shoe and a shield to keep the loose earth from falling into the trench. The cutting shoe shapes the bottom of the trench for the drain. The shield is long enough to allow the drain to be placed in a clean trench within the shield. The excavating buckets carry the excavated material upward and deposit it on a conveyor which deposits it on the ground at one side of the trench.

Different sizes of bucket-wheel-type trenchers are available for various depths and widths of the required excavation. They may be mounted on wheels or on semi-crawler or full-crawler frames. Buckets may be changed to fit the type of soil in which the excavation is to be made. Some machines are equipped with a tile chute which carries the tile down into the trench shield where the tile layer standing in the shield checks the laying of the tile. Some machines are equipped with various types of cutters to cut the topsoil into the trench after the drain has been laid to blind the drain. Others are equipped with conveyors which catch the excavated material and carry it back of the

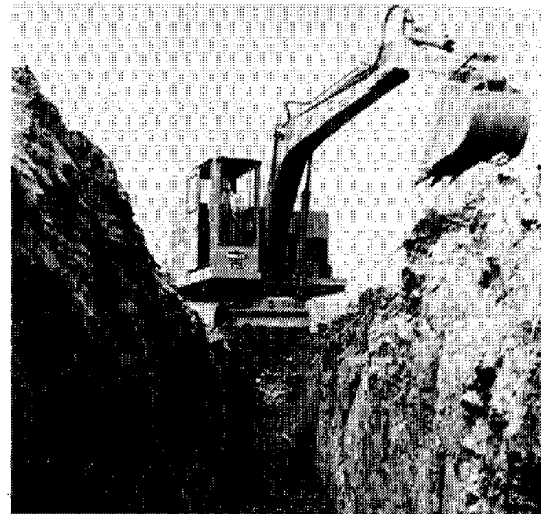

Courtesy of Insley Manufacturing Corporation

A backhoe machine

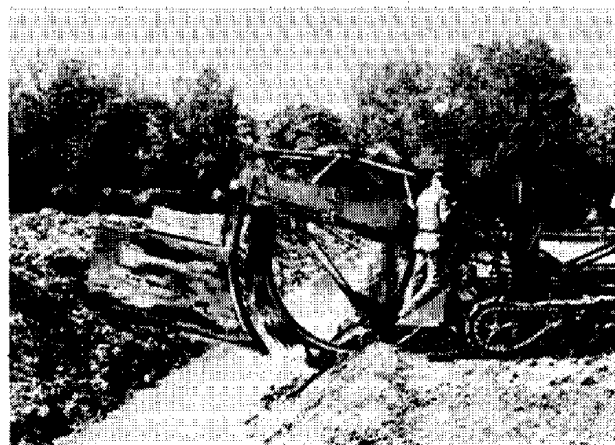

A bucket-wheel-type trencher

trench shield to complete the backfilling. Many persons prefer this automatic backfilling as the installation is completed in one operation. The bucket-wheel-type machine is of a somewhat rigid construction and cannot follow a very sharp curve; however, the grade on moderate curves is maintained accurately if rocks are not encountered.

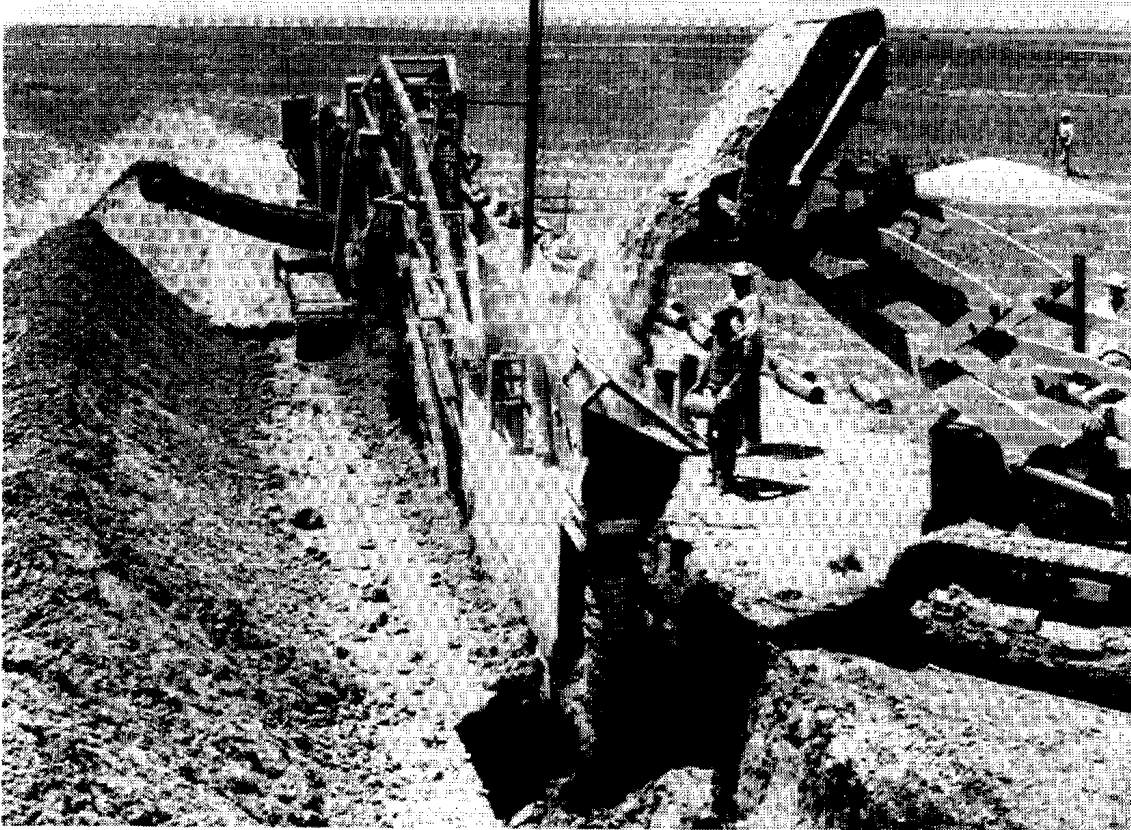

Courtesy of Gar Wood Industries

A bucket-ladder-type trencher

The bucket-ladder-type trenching machine has a ladder-type boom around which the excavating buckets move on an endless chain. The excavated material is loaded on a conveyor which deposits it alongside of the trench. Trench shields are used behind the buckets to keep the spoil and crumbs in the trench so the material can be removed by the buckets. The depth of the trench is maintained by the raising and lowering of the ladder. This machine is a fast excavator and can follow a rather sharp curve but it is difficult to keep on grade on curves and the grade requires constant checking. Various widths of trench can be cut with this type machine as the buckets can be changed as desired. It is capable of excavating deeper trenches than the bucket-wheel-type machine generally used in farm drainage.

The backhoe machine is used where drains are to be laid in trenches deeper or wider than can economically be excavated by other trenchers. The trench-hoe bucket is in the form of an inverted dipper which is drawn toward the operator like a hoe. Usually the smaller sizes are used for drain trenching.

Laying the tile

Tile laying should always start at the outlet and proceed upgrade to permit drainage of any water that accumulates in the trench. On many jobs where tile and a trencher are used the tile are laid within the shield by hand. A helper passes the tile to the tiler who lays the tile with the proper gap between the tile. Some machines are equipped with a chute on which the tile is placed to be lowered to the tiler. Sometimes tile of 8-inch diameter or less are laid by the tiler from the ground level using a tile hook. The tile is lowered by the hook into place and tapped to obtain the proper spacing. Some tilers who stand in the trench prefer to snug the tile up with a tap of the boot heel. Care must be taken when this is done to maintain the recommended spacing. The tiler should reject all tile that are cracked or so ill-shaped that a smooth line cannot be laid.

Some of the larger machines have a hydraulic ram in the shoring cage which presses the tile together and holds them in place. When this type of equipment is used, tile spacers should be employed to insure the proper gap space. These machines are usually used where deep drains 7 feet to 10 feet in depth are installed.

Installation of corrugated-plastic-drainage tubing

Corrugated-plastic-drainage tubing must be installed in a way to insure firm soil support for its entire circumference. This may be accomplished by shaping a semi-circular groove in the trench bottom to the size required to fit one-half of the tubing, and using loose, friable soil or sand-gravel material to completely fill around the sides and over the top of the tubing after it is placed in the groove. A satisfactory installation also can be made by bedding the tubing in a sand-gravel material, from which soil materials smaller than the No. 60 mesh sieve and larger than the 3/4-inch sieve should be removed. The bedding should be at least 3 inches thick around the tubing, and no rocks or hard clods should be permitted in it.

The bedding and backfill should be placed in such a way that displacement of the drain will not occur. The bedding or blinding material should be placed

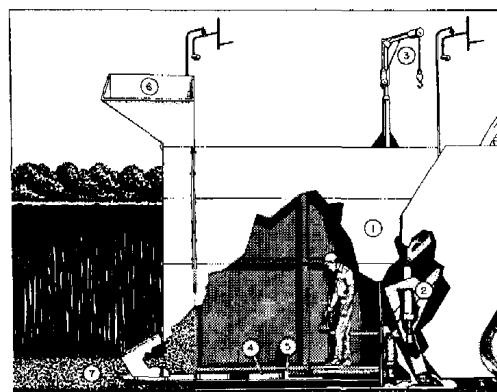

Courtesy of Gar Wood Industries

Hydraulic ram in shoring cage

1. The shoring cage provides protection for the man to lay pipe in the trench as the machine digs.
3. Electric jib crane handles pipe from the ground to lower it into the shoring cage.
4. The pipe layer places the pipe into position as it is lowered.
5. Pipe is positioned in line on rails at the grade line, 6 inches above the trench bottom and the hydraulic ram couples the pipe to the preceding pipe and holds the pipe line under pressure as the machine digs.
6. Wide hopper opening facilitates easy loading of the hopper.
7. Material falls around the pipe providing a 6-inch base and insuring perfect alinement.

The bedding and backfill should be placed in such a way that displacement of the drain will not occur. The bedding or blinding material should be placed

over the tubing before or soon after it leaves the shield. This is especially important if there is water in the trench.

To take advantage of the characteristics of plastic-drainage tubing, equipment specifically adapted to install it is needed. The equipment should cut a trench only as wide as necessary for the tubing and the envelope or filter material required. This considerably reduces the horsepower required for digging the trench and the material required for bedding or filter. A list of useful features for equipment follows:

1. Cutting wheel or ladder with interchangeable blades for cutting 10-inch and 12-inch trenches--with or without groove for 4-, 5-, and 6-inch tubing.
2. Hopper for sand-gravel for envelope-bedding-filter material, with screen on top to remove oversize material and with chutes to deliver material ahead of and under the tubing and to cover the installed tubing. (Some materials may require pre-removal of fines.)
3. Rack for a roll of the tubing located conveniently to deliver the tubing to trench with as little stretch as possible. Guides for tubing should be nonrestrictive.
4. Positioning guides to hold tubing centered in trench while envelope-bedding material is placed.
5. Conveyor for automatic backfill.
6. Holder for roll of plastic sheeting--width depends on method of installation and size of tubing.

Plastic sheeting over the drain serves to force water to enter the drain from below. Installing the drain in a bed of sand-gravel material and covering the installation with a sheet of plastic prior to backfilling is an excellent way to reduce the velocity of flow into the drain and the amount of sediment carried into it (15, 16).

Drain junctions and curves

Factory made fittings are superior to field fabricated junctions and they should be used where obtainable. When not available fittings must be made by cutting the drain. To make a fitting with tile, a sound tile should be filled with dry sand to prevent vibration and facilitate the cutting. The tile ends should be covered with two boards and while holding the sand in place, a prolonged series of light taps in the same spot should be made with a hammer. A small hole will soon be made without cracking the tile, provided care is used and the job not hurried. The hole size can then be increased by use of a monkey wrench. Concrete is usually placed over the junction to be sure that the connection is held in place.

Placing filters and envelopes

Filters and envelopes are of two general types of material. The most commonly used types are granular materials, i.e., gravel or organic particles. The second, and less common type used for filters, is in the form of fabrics or mats which may cover part or all of the drain. Filters and envelopes may be placed by hand or by machine. On large projects, modern machines that excavate the trench, place the filter or envelope, place the drain, and backfill

the trench are in common use. On small isolated projects placement of the drain and filter or envelope material is usually a hand operation.

Trencher placement of granular filters and envelopes

Most of the larger drainage trenchers have a hopper attached to the rear of the shoring case or shield to carry granular materials and feed it through feed tubes to the space around the drain. The hopper is kept supplied with material from storage piles or from a truck which drives along the trench. As the trencher moves forward, the granular material flows through the feed tubes by gravity. One tube feeds material to the bottom of the trench and after the drain is placed the other tubes feed material to cover it. Adjustments on the shoring case and feed tubes make it possible to regulate the depth of material below and above the drain. The thickness of the material on the sides of the drain is governed by the trench width. Generally these trenchers operate well as long as the hopper is well supplied with material and there is free flow through the hopper and feed tubes. The operator must exercise care to insure that foreign objects that would plug the hopper are excluded. Wet, fine grained, or cohesive materials will not flow freely through the feed tubes. Hoppers should be equipped with a grating to exclude oversize materials and foreign objects. To insure that the proper envelope or filter thickness is being obtained, periodic inspections should be made immediately behind the shoring cage prior to backfill operations. Where automatic backfill attachments are used, it is necessary to stop the trencher for a short time during the inspection of filter and envelope installation.

Trencher placement of fabric filters

Where fabric or mat-type filters or plastic strips are used, it is necessary to have a reel attachment on the rear of the trencher. These can be mounted on any type trencher and are usually fastened to the rear of the grading shoe. Fabric or mat-type filters and plastic strips are packaged in continuous rolls that can be mounted in the reel. When installation starts, the free end of the roll of material is fastened to the top of the drain. The filter or plastic strip rolls off the reel as the trencher moves forward. Backfill material tends to shape the material over the top and around the sides of the drain. When in place, the filter material should cover about 70 percent of the outside circumference of the drain. Plastic strips are usually used over the top of the drain with a sand-gravel filter underneath the drain. Plastic should cover the part of the drain above the filter.

Extreme care must be exercised in placing fabric filters to insure that the material is centered over the drain. Difficulty is often experienced under conditions of gusty winds that whip the fabric strip as it leaves the reel. Care must also be exercised in the backfill operation to avoid rupturing the fabric.

In some areas, trenchers have been equipped with two reels; one to feed fabric or mat-type filter in the trench bottom ahead of the drain and one to place it on top as previously discussed. This facilitates complete coverage of the drain with filter material and is considered good practice.

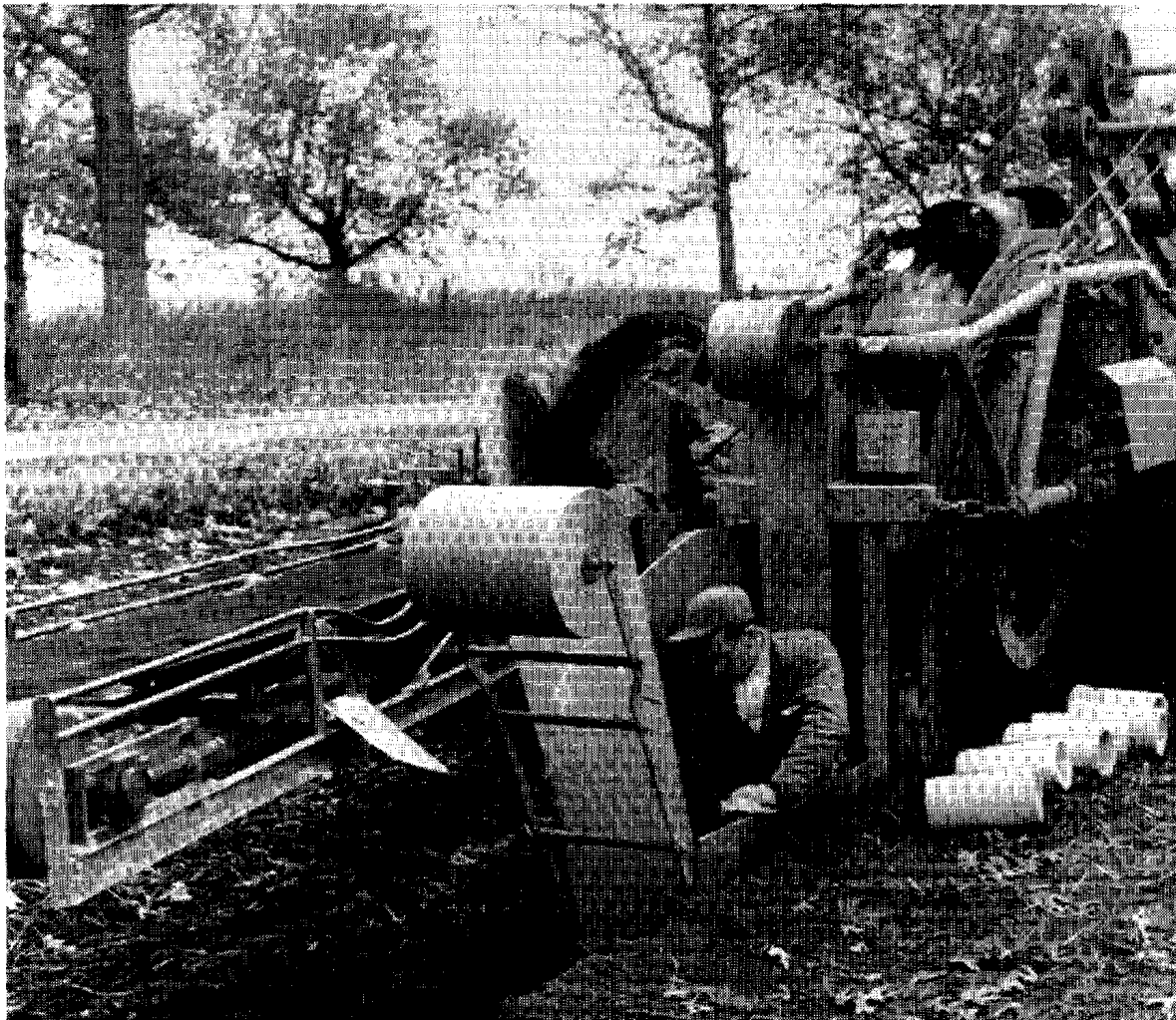

Installing fiber mat base and filter

Hand placement of granular filters

When trenches are excavated with small trenching machines without hopper attachments, by hand, or by other equipment such as backhoes, or draglines, it is necessary to place the filter material manually. Many techniques have been developed for placing filter material in the trench and around the drain. One of the best methods is to use a standard ready-mix truck. The hopper is loaded with the material to be used and then driven along the trench with the chute discharging into the trench. With proper regulation it is possible to deposit the proper amount of filter material uniformly in the trench. Very little hand spreading is needed subsequent to this operation.

Blinding the drain

Careful placing an initial backfill of 6 to 12 inches of soil around and over the drain is referred to as blinding. This is done to insure that the drain will remain in line when the remaining excavated material is placed in the trench. Except in those areas where chemical deposits in and around the drain are a problem, the soil should be topsoil or other porous soil except that fine sands and silts should not be used. Blinding the drain may be done

by shaving off the topsoil at the top of the trench with a spade taking care that the alignment of the drain is not changed. A number of methods have been devised for blinding. One method is the use of a double plow arrangement which straddles the trench and cuts both sides of the trench. This is pulled by a tractor. The plows may be an additional attachment to the trenching machine, or they may be mounted on a separate unit pulled by a tractor. Several different attachments have been made for trenchers for blading topsoil into the trench as the drain is being laid. The use of the attachment does not permit examination of the drain after the drain is laid and it is necessary to stop the trencher periodically for inspection. When a granular filter is being installed, the use of a backfiller is considered as adequate blinding. Blinding is not necessary where drains are placed in sand and gravel filters or envelopes.



Blinding drain with a spade

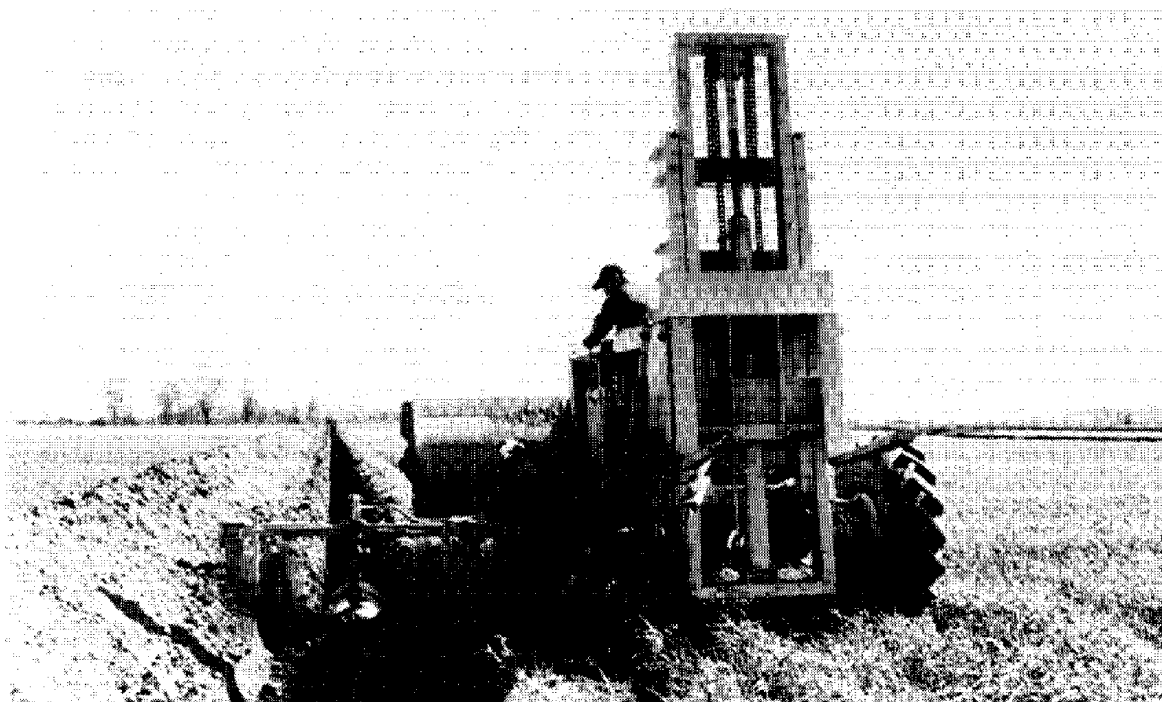

Blinding drain with machinery

Backfilling the trench

Various methods are used to move the remaining excavated material back into the trench and mound it up over the trench to allow for settlement. This may be done by hand with shovels, or by grader, bulldozer, trench hoe, dragline, auger, or any method which is convenient. Some trenchers are equipped with mechanical backfillers and the excavated earth is moved back on a conveyor and rolls off into the trench behind the trench shield. The soil becomes mixed on the conveyor so that a mixture of topsoil and subsoil is placed over the drain. Blinding the drain is accomplished by this method as the backfill rolls into the trench in such a manner that the alignment is not disturbed.



Backfilling with machinery

Problems involved in drain installation

Most problems in drain installation are rather minor where good soil conditions exist and ground water is not present. A good planning and staking job can eliminate many problems. Good planning will recognize many of the difficulties which may be encountered during construction and the contractor can be prepared to meet them.

Quicksands and silts

Whenever the plans indicate that there is a considerable amount of fine sand, especially wet sand, the installation should be delayed until the water table is at its lowest elevation. Dry sand presents a problem but fluid sand which runs into the trench and covers the drain before filters can be installed presents a most difficult situation. In many lines sand pockets may be found that make construction difficult but if the problem is limited in extent the problem can be solved by using some special procedures.

It may be possible to plan the drain through the sand at a shallower depth so the problem of installation will be decreased. Caving of the trench sidewalls is always a problem. In some cases the drain shield may be made longer to protect a greater length of the trench. The drain should be laid as soon as possible after the shoe has passed. The protection of the shield may give enough time to wrap the joint provided the trencher advances slowly. The drain should be blinded as soon as possible and the trench filled.

When the sands are saturated, the machine should be kept moving. Stopping the machine in saturated sand will permit the sand and water to build up over the drain in the shoe and make it impossible to keep sand out of the drain already installed. If the trencher is stopped, the shoe will settle in the wet sands and cause a low spot in the grade. A poor foundation results when the trencher is again started. Blinding the drain should be done with great care to prevent it from being knocked out of alignment and grade. If the trench walls cave so that the caving material falls vertically on top of the drain very little damage may be done; but if they settle vertically or slip down, the drain will be pushed out of line. The damage should be repaired immediately. The conveyor should be set to throw the excavation as far out from the trench as possible to relieve the weight on the trench side walls and to prevent the wet sands from running back to the cutting wheel.

If laterals are to be installed in this portion of the main drain, sufficient time should elapse to permit the ground water to drain out.

It is important that the drain laying and backfilling should be done quickly following excavation of the trench. It is good practice to have no more than 12 feet of trench open at a time because of the possibility of the banks sliding in and causing the trench bottom to be forced up. If the job is interrupted, the work should be completed as far as the trench is opened.

If it becomes apparent that the foundation cannot be stabilized by placing good mineral soil or gravel in the bottom of the trench, then ladders may be installed using the board and cleat method to install a cradle for the drain. In lieu of this, a continuous plastic, bituminized fiber or metal pipe may be installed. The continuous conduit will usually solve the grade stability problem, but the problem of laying it to grade may be difficult.

Crushed rock has been used in many installations to stabilize the grade. After crushed rock has been placed in the bottom of the trench, the grade must then be established.

Inspection of drain installation

General

Inspection should be carried on periodically throughout the construction stage to insure conformance with plans and specifications. The following items should be checked:

1. Quality of tile, tubing, pipe, and other materials.
2. Alignment, depth, and grade of drain.
3. Trench width at top of drain.
4. Joint spacing of tile.
5. Connections.
6. Bedding.
7. Filter or envelope materials and installation.
8. Blinding methods.

9. Backfilling methods.
10. Outlets.
11. Auxiliary structures.

Checking grade

Reasonable allowance should be made for errors resulting in small variations from planned grade and for slight unevenness in the diameter of individual drains; however, a reverse grade should never be permitted in drain lines.

Mole construction

Equipment

Several basic types of mole plows are used. One is the wheel type where the coulter is attached to a suspended axle on wheels. A second is the beam type where the coulter is attached to a horizontal beam that rides directly on the ground. Both types are mounted on a unit separate from the power unit. The beam-type plows are generally most satisfactory in that greater uniformity is obtained in both alignment and smoothness of the mole wall. A third and more recent type is the plow that is directly mounted on the power unit and depth adjustment controlled hydraulically.

Mole size

Four-inch plugs are commonly used to form the mole. This size provides a channel of ample capacity for the grade, lengths, and areas recommended. Sizes greater than 4 inches are not desirable since they increase the required draft of the plow and tend to develop roughness and less uniform channel walls. Also channels of greater size do not flush themselves as readily as do smaller channels. Six-inch moles, however, have been satisfactory in organic soils where increased size is desired to compensate for reduced cross sections caused by the expansion of the wall material into the cavity.

Depth

Moles must be drawn sufficiently deep for protection against the effects of drought, frost, and loads from heavy farm equipment. Greater depths provide greater protection from inwash of silts through the coulter slit and at the same time provide somewhat better drainage by extending the area of fissures and cracks developed by deeper plowing when the mole is formed. Greater depths require greater power and thus increase installation costs. Best results usually are obtained at depths of 20 to 24 inches, the former being satisfactory when the moled area is in a long rotation of grass and hay. Occasionally some adjustments in depth are necessary in order to draw the mole through the most suitable strata in the soil profile.

Spacing

Since the fractures of the soil profile developed by the mole plow extend only a few feet on either side of the line, uniform drainage requires the moles to be drawn as nearly parallel as possible and at close spacing. Intervals of 9 to 12 feet give good results and a 10-foot interval is commonly used. Somewhat wider spacing of 12 to 15 feet gives equally good results when lines are drawn across sloping land.

Construction

Moles should be drawn when moisture conditions are favorable. This occurs when the surface is sufficiently dry to provide traction for the mole plow

and the subsoil is sufficiently moist to provide plasticity for molding a smooth channel wall. Usually late spring and sometimes late autumn are the times of the year best suited. A dry surface is also essential because any standing water which can enter directly through the coulter slit softens and collapses the thin earth plug which re-forms and seals off the roof of the mole cavity. Collapse of the cavity roof causes deposition of silt into the channel, which usually plugs the drain. A dry subsoil causes the plow to shatter and tear the cavity lining leaving a channel which drops excessive silt with resultant plugging.

Construction procedure. - Best results are obtained when the mole plow is drawn up grade. Fissures in the soil then open up in the direction of natural drainage and facilitate rather than block the gravitational movement of the water. However, the economy of two-way haulage on some sites may offset any advantage gained by drawing lines upslope only. Moles should not be drawn too rapidly. Venting behind the plow may be desirable to reduce suction and possible collapse of the mole wall.

Coulter slits should be closed at the ground surface as soon after moling as possible. This can be done by harrowing and disking. Water will then seep into the mole rather than wash in. Rainfall, washing into unprotected slits, has been observed to carry in sufficient silt to fill a mole line within several hours. Adequate application of lime and fertilizer should be included in the initial preparation of the land for crops. Adequate lime appears to prolong the life of mole drains.

Construction of open ditches for subsurface drainage

Construction of open ditches for subsurface drainage is similar to construction of open ditches for surface drainage. In most cases both surface and subsurface drainage water are carried in the same ditch. Design, construction, and maintenance of open ditches are covered in Chapter 5 of this handbook.

Maintenance of Buried Drains

General

A subsurface drainage system of adequate design and proper installation, using good material, requires little maintenance to keep it operating. Inspection of the drains, especially after heavy rains, should be made to see if they are working and if maintenance is required.

Outlets

The outlet end of the system must be kept clean if the maximum benefits from the drain are to be obtained. Sediment and debris sometimes gather over the outlet and may entirely plug the outlet. A good subsurface drainage system may fail because the outlet ditch fills up with silt and vegetation. The outlet ditch should be improved to permit free flow from the drain outlet. Outlets are usually protected from small animals by installing a flap gate or a grating. If this is not done, small animals may use the outlet for nesting. The outlet should be inspected to determine if it is clear.

Water-surface inlets

Surface water inlets are subject to damage and may require frequent repairs. If holes wash around the inlets, they should be repaired. Trash which seals over the inlet gratings or trash racks should be removed. Frequent inlet inspection will insure prompt removal of surface water.

Sand traps and catch basins

Where drains are laid in sand, usually sand traps or catch basins are built to catch the sand. Traps will not keep sand from filling drains unless the traps are kept clean. The traps should be checked frequently after the drain has first been installed. Cleanout of the trap may be less frequent as the drain ages.

Blowouts

Quite often holes develop over the drain. These holes, known as blowouts, may be caused in construction by leaving too wide a gap at joints. Other causes might be broken tile or improperly made drain junctions. Blowouts may be caused by insufficient cover and high pressures within the drain. Drains crushed by heavy farm equipment may cause holes which result in the drain filling with soil. If repairs are not made immediately, damage will increase. To make repairs the drain must be exposed at the point of the blowout and the drain replaced, cementing junctions or covering wide joints with tar impregnated paper and tile bats (broken pieces of tile).

Tree roots

If trees near the drain are not removed at the time of construction, the drain may become plugged by tree roots. If the drain is not functioning and the outlet is open, the drain should be checked near trees. To repair the line, dig it up, clean it, and re-lay it. Unless the trees are removed or killed, this is only temporary repair which may have to be repeated periodically. One way to prevent a recurrence would be to replace the part of the drain near the trees with sewer pipe and carefully seal the joints or install a conduit without perforations or joints.

The roots of some trees such as cottonwoods and willows cause more trouble than hardwood, fruit, and nut trees. Many drains through orchards have functioned effectively for many years. The placement of drains at greater depths in orchards will help eliminate the problem of roots clogging the drain. The distance roots travel to a drain depends on the species of the trees, climate, and variations in drain flow. Safe distances from drains of various species of trees should be established locally.

Auxiliary structures

The life and value of a drainage installation often depends on the maintenance and repair of auxiliary structures. These structures are essential to the proper functioning of a drainage system. If they are not maintained, the system will not operate as planned. Regular inspection is required.

Waterways over drains

Drains are often laid under or at one side of waterways. Drains laid under the center of the waterways are not recommended because surface water seeps into perforations or joints in the drain and carries soil into the drain. When enough soil is displaced, a large hole develops. Where it has been necessary to place a drain under a waterway, it should be inspected regularly.

Mineral deposits

Malfunctioning (17) of drains in several parts of the country has been caused by mineral deposits in the drains. Accumulation of insoluble black and/or red materials, mainly manganese or iron oxide (bog ore), may be found in the line. The mineral deposits do not seriously affect the operation of the drain unless the perforations or joints become sealed. Indication of the presence of the deposits may be seen at the outlets or at junction boxes and inspection holes. Sulphur dioxide gas injected into the upper end of the drain from tanks of compressed gas has proved successful in opening the drain. The gas should be held in the line for 24 hours after the air has been replaced by the gas. High pressure hydraulic cleaners are also used to clean the drain.

Miscellaneous

Inspection wells, catch basins, etc., installed in a drainage system may be used to locate the portion of the system which is not operating properly. Examining the drains after heavy flows should give enough information so that the trouble can be located. Where a system does not have inspection wells, the drain must be excavated at intervals until the trouble is located.

Failure of a drain installation to operate as expected may result from other factors such as:

1. Drains installed with insufficient capacity, drains placed too shallow, and lack of auxiliary structures.
2. Drains of insufficient strength or lacking in other qualities necessary for the installation.
3. Poor construction resulting in such inadequacies as too wide or too small a joint spacing; improper bedding; poor grade and alignment; improper backfilling; and substandard appurtenances.

References

- (1) UNITED STATES DEPARTMENT OF AGRICULTURE.
1941. Climate and Man. U. S. Dept. Agr.
Yearbook 1941.
- (2) UNITED STATES SALINITY LABORATORY STAFF.
1954. Diagnosis and Improvement of Saline
and Alkali Soils. U. S. Dept. Agr.
Handb. 60.
- (3) BERNSTEIN, LEON.
1964. Salt Tolerance of Plants. U. S. Dept.
Agr. Inf. Bul. 283.
- (4) _____
1965. Salt Tolerance of Fruit Crops. U. S.
Dept. Agr. Inf. Bul. 292.
- (5) COOPER, HILTON H., JR., KOHOUT, FRANCIS A.,
HENRY, HAROLD R., and GLOVER, ROBERT E.
1964. Sea Water in Coastal Aquifers. Geol.
Sur. Water Sup. Paper 1613-C.
- (6) JESSUP, L. T.
1933. Discharge of Drains Serving Irrigated
Lands. USDA, Bur. of Agr. Eng.
- (7) MUSKAT, M.
1937. The Flow of Homogeneous Fluids Through
Porous Media. McGraw-Hill Book
Co., New York, N. Y.
- (8) HOOGHOUDT, S. B.
1940. Bijdragen tot de kennis van enige
natuurkundige grootheden van de
grond nr. 7. Versl. Landb. Onderz.
46: 515-707. Algemeene Landsdrukkerij,
The Hague.
- (9) BOUWER, HERMAN and VAN SCHILFGAARDE, JAN.
1963. Simplified Method of Predicting Fall
of Water Table in Drained Land.
ASAE Trans., Vol. 6, No. 4, pp 288-291
& 296.
- (10) MANSON, PHILIP W. and BLAISDELL, F. W.
1956. Energy Losses at Drain Tile Junctions,
Agr. Eng. 37:249.
- (11) ARMCO DRAINAGE & METAL PRODUCTS, INC.
1955. Handbook of Drainage and Construction
Products, Armco Drainage and Metal
Products, Inc., Middletown, Ohio.

- (12) SPANGLER, MERLIN GRANT.
1951. Soil Engineering, International Textbook Co., Scranton, Pennsylvania.
- (13) MILLER, DALTON G. and MANSON, PHILIP W.
1948. Durability of Concretes and Mortars in Acid Soils with Particular Reference to Drain Tile. Technical Bulletin No. 180, Agricultural Experiment Station, University of Minnesota, St. Paul, Minnesota.
- (14) _____
1951. Long Time Tests of Concretes and Mortars Exposed to Sulfate Waters. Technical Bulletin No. 194, Agricultural Experiment Station, University of Minnesota, St. Paul, Minnesota.
- (15) WILLARDSON, L. S., FOUSS, J. L., REEVE, R. C., and FAUSEY, M. R.
1968. Entry Velocity Control Limits Drain Sedimentation, Journal of the Irrigation and Drainage Division, ASCE, Proceedings Paper 6300, IR4, December 1968.
- (16) PILLSBURY, A. F.
1967. Observations on Tile Drain Performance, Journal of the Irrigation and Drainage Division, ASCE, Proceedings Paper 5447, IR3, September 1967.
- (17) MACKENZIE, ARNOLD J.
1962. Chemical Treatment of Mineral Deposits in Drain Tile, Journal of Soil and Water Conservation, Vol. 17, No. 3, May-June 1962.

NATIONAL ENGINEERING HANDBOOK

SECTION 16

DRAINAGE OF AGRICULTURAL LAND

CHAPTER 5. OPEN DITCHES FOR DRAINAGE - DESIGN, CONSTRUCTION AND MAINTENANCE

| <u>Contents</u> | <u>Page</u> |
|---|-------------|
| General | 5-1 |
| Location | 5-1 |
| Channel location under nonerosive conditions | 5-2 |
| Channel location under erosive conditions | 5-2 |
| Location of diversion ditches | 5-3 |
| Layout of ditches in humid areas | 5-3 |
| Location of drainage ditches in western irrigated lands | 5-3 |
| Curves in ditches | 5-3 |
| Required Capacities | 5-4 |
| Drainage coefficients | 5-4 |
| General | 5-4 |
| Effect of outlet capacity on selection of drainage coefficients | 5-5 |
| Coefficients for subsurface drainage | 5-5 |
| Coefficients for surface drainage | 5-6 |
| Determination of coefficient "C" for use in surface drainage formula | 5-6 |
| Example for computing "C" values | 5-14 |
| Computation of design flow | 5-14 |
| Combining flows from areas on which different coefficients are used to compute design flow | 5-14 |
| Drainage coefficients for steep and other areas | 5-15 |
| Total storm runoff and peak flow | 5-15 |
| Volume of runoff | 5-15 |
| Peak runoff and hydrographs | 5-18 |
| Design Standards | 5-18 |
| Channel design | 5-18 |
| Value of "n" for design | 5-18 |
| Channel section | 5-19 |
| Depth | 5-19 |
| Bottom width | 5-19 |
| Side slopes | 5-19 |
| Ditch stability | 5-20 |
| Berms and spoil banks | 5-20 |
| Design Procedure | 5-21 |
| General | 5-21 |
| Establishing the hydraulic gradeline | 5-22 |
| Computing ditch sizes at junctions - 20-40 rule | 5-23 |
| Computing equivalent drainage area | 5-24 |
| Flow from reservoirs into drainage systems | 5-27 |

| | <u>Page</u> |
|--|-------------|
| Hydraulic design at culverts | 5-27 |
| Hydraulic design at bridges | 5-30 |
| Computing cross section of ditch | 5-30 |
| Allowance for initial sedimentation | 5-32 |
| Establishing bottom grade of ditch | 5-32 |
| Design of large open-ditch system | 5-33 |
| | |
| Auxiliary Structures and Practices | 5-39 |
| Junctions of lateral ditches | 5-40 |
| Overfall pipes and structures | 5-40 |
| Hydraulic design of "island-type construction" | 5-41 |
| Drop spillways | 5-41 |
| Chutes | 5-43 |
| Sod chutes | 5-43 |
| Grade-control structures | 5-43 |
| Culverts and bridges | 5-43 |
| Culvert depth | 5-44 |
| Watergates, cattle guards and ramps | 5-44 |
| | |
| Construction Plans | 5-44 |
| General | 5-44 |
| Drainage plan maps | 5-46 |
| Profiles | 5-46 |
| Cross sections | 5-47 |
| Soil borings | 5-47 |
| Ditch-design calculations | 5-47 |
| Structure details | 5-47 |
| Specifications | 5-48 |
| | |
| Maintenance of Open Ditches | 5-48 |
| Responsibility for maintenance | 5-49 |
| Working out a maintenance plan | 5-49 |
| Past history of maintenance | 5-50 |
| Economics of maintenance | 5-50 |
| Methods of maintenance | 5-50 |
| Using construction equipment for maintenance | 5-50 |
| Mowing | 5-51 |
| Pasturing | 5-51 |
| Burning undesirable vegetation | 5-51 |
| Chemical control of vegetation | 5-51 |
| | |
| References | 5-52 |

Figures

| | |
|---|------|
| Fig. 5-1 Key map showing drainage coefficients for use in drainage design | 5-8 |
| Fig. 5-2 Drainage runoff curves | 5-9 |
| Fig. 5-3 Drainage runoff curves | 5-11 |
| Fig. 5-4 Determination of coefficient, C, in the drainage formula: $Q = CM^{5/6}$ | 5-13 |
| Fig. 5-5 Drainage runoff curves for sample drainage ditch design | 5-25 |
| Fig. 5-6 Procedure for design of drainage ditches at culverts | 5-29 |
| Fig. 5-7 Sample--Condensed plan profile | 5-35 |

Tables

| | | |
|-----------|---|------|
| Table 5-1 | Suggested minimum radius of curvature in stable soil without bank protection | 5-4 |
| Table 5-2 | Value of "n" for drainage ditch design | 5-18 |
| Table 5-3 | Ditch side slopes for use with various maintenance methods | 5-19 |
| Table 5-4 | Sample--Drainage ditch design | 5-37 |

NATIONAL ENGINEERING HANDBOOK

SECTION 16

DRAINAGE OF AGRICULTURAL LAND

CHAPTER 5. OPEN DITCHES FOR DRAINAGE - DESIGN, CONSTRUCTION AND MAINTENANCE

General

This chapter outlines procedures for designing, constructing, and maintaining open ditches for agricultural drainage. It covers ditches and reconstructed channels used primarily as outlets for drainage systems occupying broad river bottoms, deltas, coastal plains, lake plains and upland prairies where the general topography is flat to mildly sloping and where surface waters are diffused. Where channels extend from such areas into narrowing bottoms and steeper slopes adjoining or into uplands, additional guidance for design and stability checks as covered in SCS Technical Release No. 25 should be used to assure protection against degradation and bank erosion. The procedure and criteria also is applicable to the design of drainage ditches used for interception drainage. Chapter 3, Surface Drainage, deals with small field ditches. Chapter 4, Subsurface Drainage, contains criteria for planning ditches for use in subsurface drainage of agricultural land.

The design of drainage ditches must give due consideration to the equipment and methods to be used for construction, and to the needs for and methods to be used in maintaining the ditches. The design must be based on adequate consideration of the following interrelated factors:

1. The ditch must be designed to meet the project needs without aggradation or degradation of the channel bed or erosion of the channel banks.
2. It must be capable of being maintained to the size and condition required to continually meet the project needs.
3. The cost of construction and maintaining the ditch must be less than the benefits which it is expected to produce.
4. The construction, operation, and maintenance of the ditch must be carried out in a manner which will not contribute significantly to downstream sediment loads or on-site deterioration in quality of the environment.

Design and construction of ditches to meet these requirements are complex jobs. Positive consideration of all factors will result in an improvement to the environment and the agricultural economy of the area served. Inadequate consideration of any of the factors listed will result in disappointment and financial loss to the owners.

Location

Drainage ditches should be located to provide the most effective drainage of the agricultural wetland. Topography, existing ditches and drains, bridges,

farm boundaries and other physical features all influence ditch location. Natural outlets such as estuaries, rivers, lakes or swamps, or old ditches usually fix the general location of an open ditch, but the alignment and efficiency of the channel may be improved by the use of cutoffs, long tangents, and smooth curves.

Open ditches should terminate in an adequate outlet. The capacity of the outlet must be adequate to carry the design discharge from the project without it resulting in stage increases which would cause significant damage downstream. This may require extending the channel improvement further downstream. A comparison of alternate locations of the point of outlet may also be needed. The stage of a stream during the storm when the drainage system is discharging at the design rate determines the adequacy of the stream as an outlet. A study of the frequency of high water stage is needed for large streams, lakes, and tidal waters to determine their adequacy as an outlet and to establish the elevation of the design hydraulic gradeline for the open ditch at the outlet. See chapter 2 for more details regarding the requirements of outlets for agricultural drainage systems.

Channel location under nonerosive conditions

Where the topography is flat and soils and velocity are well within the range of conditions where channel stability will be no problem, alignment changes can be made to fit the area. Some factors to consider when changing alignment of a ditch are: (a) Straight ditches permit rectangular fields and efficient farming. (b) A shorter channel will have more slope, greater velocity and less cross-sectional area and will be less likely to accumulate sediment than a longer channel between the same terminal points. (c) Changing the existing location may require placing the ditch on higher land, crossing farm boundaries, isolating parts of fields from the rest of the farm, and installing new bridges and culverts not otherwise needed. (d) The location may result in placing the ditch in more or less stable soils.

Channel location under erosive conditions

Some drainage ditches may be needed where site conditions are likely to cause stability problems. Flow velocity, position of the water table, soil texture, soil structure, and vegetation are the principal factors influencing channel erosion. A careful study of these factors and the protection which may be needed should be made before constructing any channel. If significant erosion is probable, alternate solutions should be considered. It may be feasible to choose another location using a longer channel on a nonerosive grade; to locate the ditch in more stable soil; or to avoid cutoffs and straightening of natural channels. Use of a wider and shallower channel to decrease the hydraulic radius and the velocity is a possibility.

If these alternatives are not feasible, grade control structures or bank protection may be needed to protect the ditch. The principal practices and structures to control erosion in drainage ditches are: grade-control structures; bank protection by vegetation; riprap; jetties of piling or trees; tetrahedrons; brush mats; and continuous piling. The use of jetties, piling, and tetrahedrons applies only to large channels. These costly measures are not normally used on drainage ditches and when used in channels with unstable soils may have a high rate of failure.

Location of diversion ditches

Open ditches often serve as diversions to protect land from overflow. Most diversion ditches are located near the edges of hilly or sloping land, and need to be deep enough to intercept seepage as well as surface flow. Excavation from diversions is often placed to form a dike on the lower side for added protection. Where the safety of levees and dikes depends on adequate capacity of the diversion, it is essential to inspect the diversion ditch regularly and perform maintenance as required to keep down undesirable vegetation and remove sediment and other obstructions to flow. Diversion channels usually are designed to handle the peak flow storm of a frequency ranging from two to 10 years. Higher protection will be required when flood protection is a purpose. Economy in channel design results from designing the main diversion to carry part of the peak flow and to route the excess flow through spillways into other channels, sloughs or overflow areas. Often the spillway may be along sections of a channel having no dike, or with the top of a section of the dike below grade of the rest of the dike to provide a fuse plug. This type of construction reduces costs, but is applicable only where site conditions permit the lower level of protection.

Small surface water diversions are used frequently in farm drainage systems to prevent surface waters from adjoining lands from flooding fields to be drained. Deep diversions to intercept ground water are used to lower the water table in the area below the diversion ditch.

Layout of ditches in humid areas

Ditch systems in humid areas provide outlets for farm ditches, buried drains, interception ditches and irrigation return flows. The most common type of drainage system constructed by drainage enterprises in flatland areas consists of a network of laterals or sublaterals spaced at intervals which will provide each farm and ranch with a dependable outlet. Where farm units are small, it may not be feasible for a drainage enterprise to provide a lateral to reach each farm and small groups of farmers may need to construct a group lateral as an outlet for their farm laterals.

Location of drainage ditches in western irrigated lands

Drainage ditches in western irrigated areas serve primarily as disposal ditches for subsurface drains in irrigated areas. Ditches located perpendicular to the flow of ground water are installed to intercept subsurface flow and are called "interceptor ditches." Ditches located approximately parallel to the flow of ground water, or where the water table is relatively flat, and at a depth and spacing required for control of the water table, are called "relief ditches."

The location of ditches is usually fixed by the irrigation or canal system and the depth and location of permeable aquifers. In irrigated areas where high intensity rainfall occurs, channels are designed to serve as dual purpose ditches for the drainage of both surface and ground water.

Curves in ditches

Where feasible, smooth curves should be used for alignment rather than sharp bends in order to improve the hydraulic property and stability of the ditches.

Where this is applicable the recommended minimum radius of curvature may be established in a local drainage guide.

Often the best surface drainage is obtained by a ditch following low swales. To improve alignment, ditches may cut through minor rises in topography. Long tangents and gentle curves facilitate the cultivation of adjoining fields by eliminating odd-shaped areas. Where the design engineer plans to establish a minimum radius of curvature, table 5-1, may be of value. This table has been used widely in design of group drainage jobs.

Table 5-1. Suggested minimum radius of curvature in stable soil without bank protection

| Kind of ditches | Fall per mile feet | Minimum radius of curvature feet | Approximate degree of curve degrees |
|---|-----------------------------|---|--|
| Small ditches maximum top width 15 feet | Under 3 3 to 6 | 300 400 | 19 14 |
| Medium-sized ditches top width 15 to 35 | Under 3 3 to 6 | 500 600 | 11 10 |
| Large ditches (more than 35 top width) | Under 3 3 to 6 | 600 800 | 10 7 |

Problems outside the range of table 5-1, and in erodible soils, require special design. Sharp changes in alignment are needed in some locations to decrease waste area in fields. Where this is done, banks should be protected to prevent erosion.

Required Capacities

Drainage coefficients

General

The drainage coefficient is the rate of removal of excess water necessary to provide a certain degree of crop protection. Chapter 1 of this handbook includes a general discussion of drainage coefficients. Some drainage coefficients are for surface drainage, some for subsurface drainage, and some for a combination of the two. Subsurface flow is more uniform and extends over a longer period of time than surface runoff. In areas subject to both excess surface and subsurface water the subsurface drainage coefficient is usually the smaller of the two.

In order to give proper consideration to the characteristics of precipitation and runoff the drainage coefficient for surface drainage is usually expressed as a curve, where the rate of removal per unit of area varies according to the size of the drainage area. Drainage coefficients for subsurface drainage are usually expressed as a certain quantity of water removal from the drainage area per day. This may be expressed as inches per day from the watershed, or cubic feet per second per square mile. For large areas the rate may decrease. Where the need for both surface and subsurface drainage exists in a watershed, consideration must be given to the requirements of each in computing the design capacity for the ditch which serves as the common outlet.

In irrigated areas where the subsurface flow is continuous and generally uniform for extended periods, it should be considered as a base flow in computing the required capacity of the outlet ditch. In those areas where subsurface flow is the result of precipitation and is intermittent, the required capacity of the outlet ditch will be governed by the surface drainage flow. After a rainstorm the surface flow usually passes its peak before subsurface flow begins. In both situations the minimum depth of the outlet ditch will be determined by its required depth for subsurface drainage of its watershed. Any open ditch in an area subject to rainstorms will periodically be subjected to runoff from storms of abnormally high intensity. The type of agriculture and other improvements in the flood plain will determine the feasibility of constructing the ditch to the size required to carry the runoff from these abnormally large rainstorms within banks. Decisions are made on an evaluation of damages which would result from overbank flow and the cost of improvements which would prevent it.

Effect of outlet capacity on selection of drainage coefficient

In selecting criteria for design of drainage improvements, due consideration must be given to the capacity of the outlet into which the drainage ditches must empty. In determining the adequacy of outlets, the following basic requirements should be met.

1. The capacity of the outlet should be such that the discharge from the project watershed, after the installation of proposed improvements, will not result in stage increases that will cause significant damages below the termination of the project ditch.
2. The capacity of the outlet should be such that the design flow from its watershed can be discharged into it at an elevation equal to or less than that of the termination of the hydraulic gradeline used for design of the project ditch. The design flow from the watershed above the outlet should be determined in the same manner as the design discharge from the project. The probability of installing additional ditches in other watersheds which are served by the same outlet, in accordance with watershed or river basin needs, should be considered.
3. Where the outlet is a channel installed by the Corps of Engineers or other federal or state agency, the capacity of the project ditch will be governed by the capacity of the outlet. Criteria for design of the project ditch should be comparable to that of the outlet in such cases.
4. Where subsurface drainage is needed, the depth of the outlet needs to be such that subsurface drains may discharge freely into mains and laterals at normal low water flow.

Coefficients for subsurface drainage

The determination of coefficients for design of subsurface drains is discussed in Chapter 4 of this handbook. In using these coefficients for determining the required capacity of open ditches which serve as outlets for subsurface drains, consideration must be given to the amount of surface flow entering the ditches also.

In computing the subsurface flow from large watersheds the following points should be considered.

1. Percent of the watershed on which subsurface drains are installed, or which is contributing subsurface flow to open ditches.
2. Type of subsurface flow - continuous or intermittent.
3. Leaching requirement in irrigated areas.
4. Effects of precipitation on subsurface flow.

Studies of the yield of drains in arid and semiarid irrigated areas indicate an average flow from areas above one square mile in size to be in the range of 2 to 4 c.f.s. per square mile. Factors favoring use of the smaller figure would be larger areas, a substantial portion of the total area not being irrigated, low to moderate leaching requirement, and a diversity of crops which will result in a more uniform rate of irrigation and therefore of drainage. Experience in the area, observation of flow from existing drainage systems, consideration of the factors affecting flow from subsurface drains, and judgment are needed to develop criteria for required capacity of ditches for drainage of large areas of irrigated land in arid and semiarid areas.

Coefficients for surface drainage

Coefficients for surface drainage of flatland are usually determined by the general formula

$$Q = CM^{5/6} \qquad \text{Eq. 5-1}$$

Q = required capacity of ditch in c.f.s.

C = a coefficient related to the characteristics of the watershed and the magnitude of the storm against which the watershed is to be protected

M = drainage area in square miles

This formula applies to areas where the natural land slopes are about 1 percent or less. The formula may be used for minor portions of steeper land in a watershed which is predominantly flatland.

Stream gage records and studies made of the flow of excess rainfall from flatland watersheds show that the rate of flow, per unit of area, decreases as the total area of the contributing watershed increases. The rate of change, indicated by the exponent of M, varies somewhat between watersheds, and with the intensity and duration of the storm producing the excess rainfall. There is adequate data, however, to justify the use of the 5/6 exponent in the formula for determining surface drainage coefficients for all flatland watersheds in the United States.

Design flow from uplands in the watershed should be computed by procedures covered in Section 4, Hydrology, NEH, or from applicable hill land drainage curves. The design flow from the watershed can then be determined by adding to computed upland flow the flow of flatland increments computed from drainage curves.

Determination of coefficient "C" for use in surface drainage formula. - In many areas of the country the value of the coefficient for use in the general formula for surface drainage, $Q = CM^{5/6}$, has been determined by many years of experience. Values which are related to the kind of protection needed by different types of agriculture and kinds of crops have been determined for

specific climatic areas in the country. This experience data is invaluable and should continue to be used. Figure 5-1 indicates the area where these drainage coefficients which are shown in figures 5-2 and 5-3 are applicable. In cases where a drainage coefficient is needed in the area west of the north-south dividing line it should be based on the characteristics of the watershed and crops to be grown and somewhat lower than the coefficients in use for similar conditions to the east of the north-south line.

There are some areas, though, where the type of agriculture is changing, or improvements are being made in the watershed which indicate the need for a more precise determination of runoff than that provided by use of the applicable drainage coefficient. In other situations there may be a need to develop a coefficient which is adapted to the specific needs of a particular watershed and the experience with similar conditions is not adequate to indicate the best coefficient to use.

Where this is the case the coefficient "C" for the surface drainage formula may be determined by the following procedure which is a combination of the recommendations of Stephens and Mills (1)* and the procedures given in NEH 4, Hydrology, for determining runoff rates.

Values of the coefficient "C" for the flatland portion of the watershed may be determined from the relationship

$$C = 16.39 + 14.75 R_e \quad \text{Eq. 5-2}$$

Where "R_e" is the rainfall excess in inches. See figure 5-4 for solution of the above equation. "R_e" should be determined in accordance with procedures in NEH 4, Hydrology, Chapter 10. An example of determining "R_e" and "C" is given on page 5-14.

In determining "R_e" for flatland watersheds the following factors should be considered.

It is normal, and not necessarily damaging, for water to accumulate to shallow depths on flatland during intense or extended periods of rainfall. Such accumulations should extend to relatively short periods of time. It is not feasible to contain all runoff within ditchbanks on flatland except for extremely low intensity and short duration storms. The level of protection on flatland refers to the duration and frequency of storms against which protection is afforded, to the extent that flooding to the depth and duration which will cause significant crop loss will not occur. Drainage formulas, with coefficients ranging from 15 to 50, generally provide this kind of protection against storms of recurrence frequency of once in 2 to 5 years, depending on the kind of crop.

In determining the degree of protection to be provided, the topography and soils need to be investigated. Land which is a foot or two higher receives a much higher degree of protection than the land at general field level on which channel design is based. Lands at the lowest elevations adjoining channels frequently are classed as "heavy" soils and are best suited to pasture or water-tolerant crops. Often the "lighter" soils, best suited for row crops, lie slightly higher in elevation. This is usually true of land built up by stream overflow. In such situations, channels designed on drainage curves

* Numbers in parentheses refer to references listed at the end of the chapter.

KEY MAP SHOWING DRAINAGE COEFFICIENTS FOR USE IN DRAINAGE DESIGN

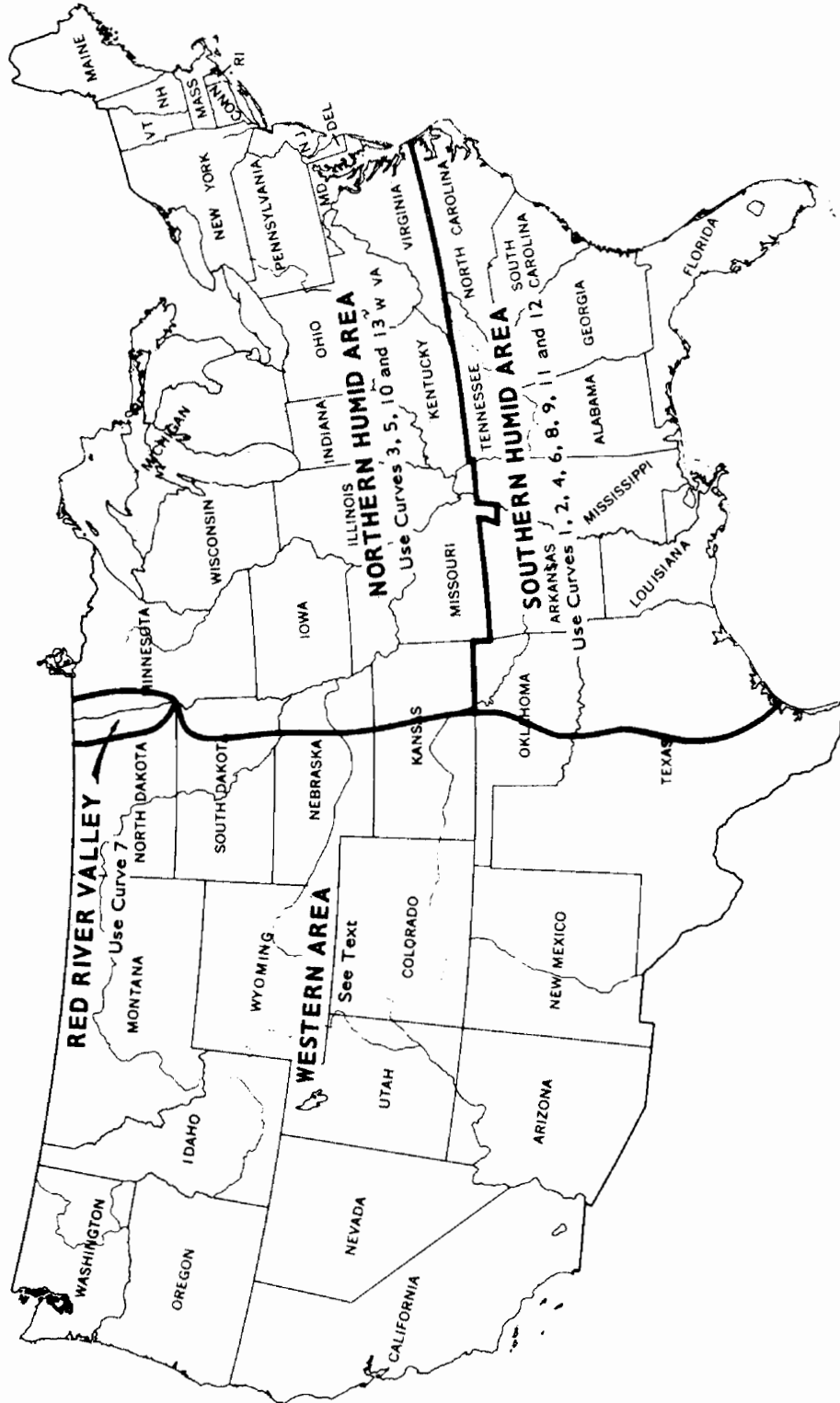

REFERENCE

U. S. DEPARTMENT OF AGRICULTURE
SOIL CONSERVATION SERVICE
ENGINEERING DIVISION - DESIGN SECTION

STANDARD DWG. NO.

ES-700

SHEET 1 OF 3

DATE 3-71

Figure 5-1, Key map showing drainage coefficients for use in drainage design

DRAINAGE RUNOFF CURVES

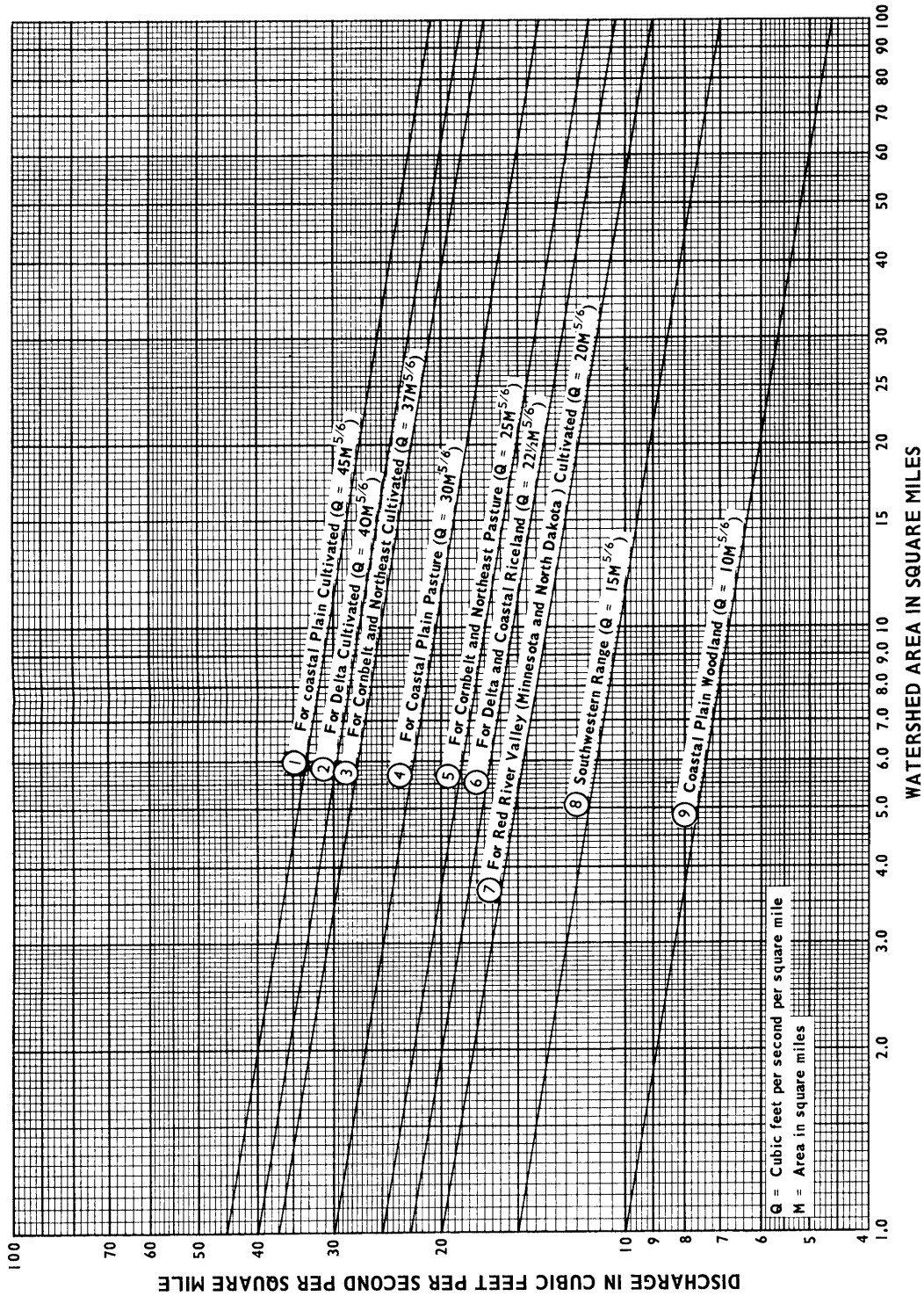

U. S. DEPARTMENT OF AGRICULTURE
SOIL CONSERVATION SERVICE
ENGINEERING DIVISION - DESIGN SECTION

STANDARD DWG. NO.
ES-700
SHEET 2 OF 3
DATE 3-71

REFERENCE
Curves 1, 2, 4, 6, 8 and 9 - Fort Worth, Texas and Spartanburg, South Carolina Engineering and Watershed Planning Units
Curves 3 and 5 - John G. Sutton, "Hydraulics of Open Ditches," Agr. Eng., Vol. 20, No. 5, May 1939
Curve 7 - Minnesota Dept. of Drainage and Waters

Figure 5-2, Drainage runoff curves

Figure 5-2, Drainage runoff curves
ES-700 - sheet 2 of 3

DRAINAGE RUNOFF CURVES

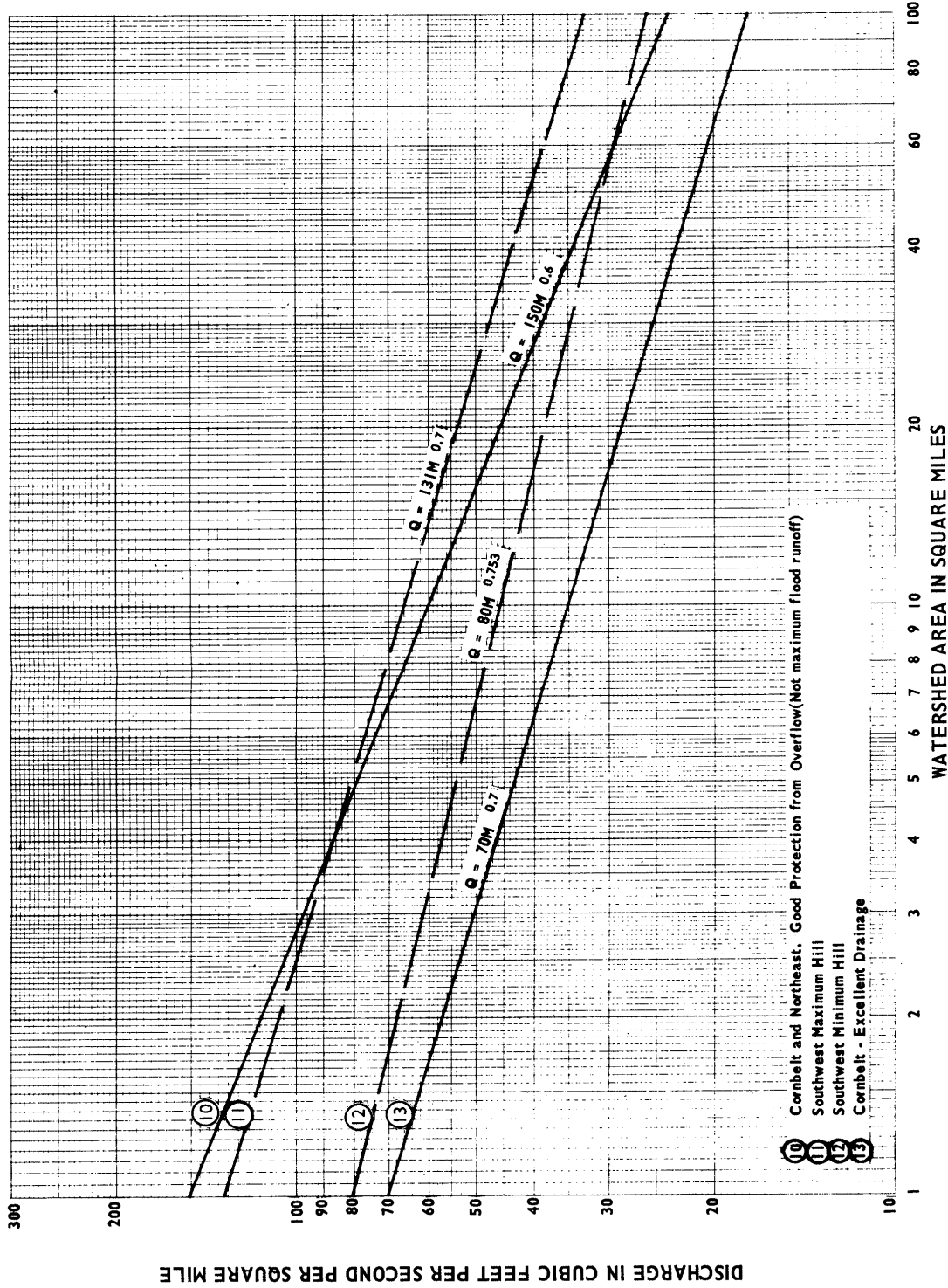

REFERENCE

Curves 10 and 13 - John G. Sutton, "Hydraulics of Open Ditches," Agr. Eng., Vol. 20, No. 5, May 1939.
 Curves 11 and 12 - Fort Worth, Texas Engineering and Watershed Planning Unit

U. S. DEPARTMENT OF AGRICULTURE
 SOIL CONSERVATION SERVICE
 ENGINEERING DIVISION - DESIGN SECTION

STANDARD DWG. NO.
 ES-700
 SHEET 3 OF 3
 DATE 3-71

Figure 5-3, Drainage runoff curves

Figure 5-3, Drainage runoff curves
ES-700 - sheet 3 of 3

DRAINAGE RUNOFF CURVES

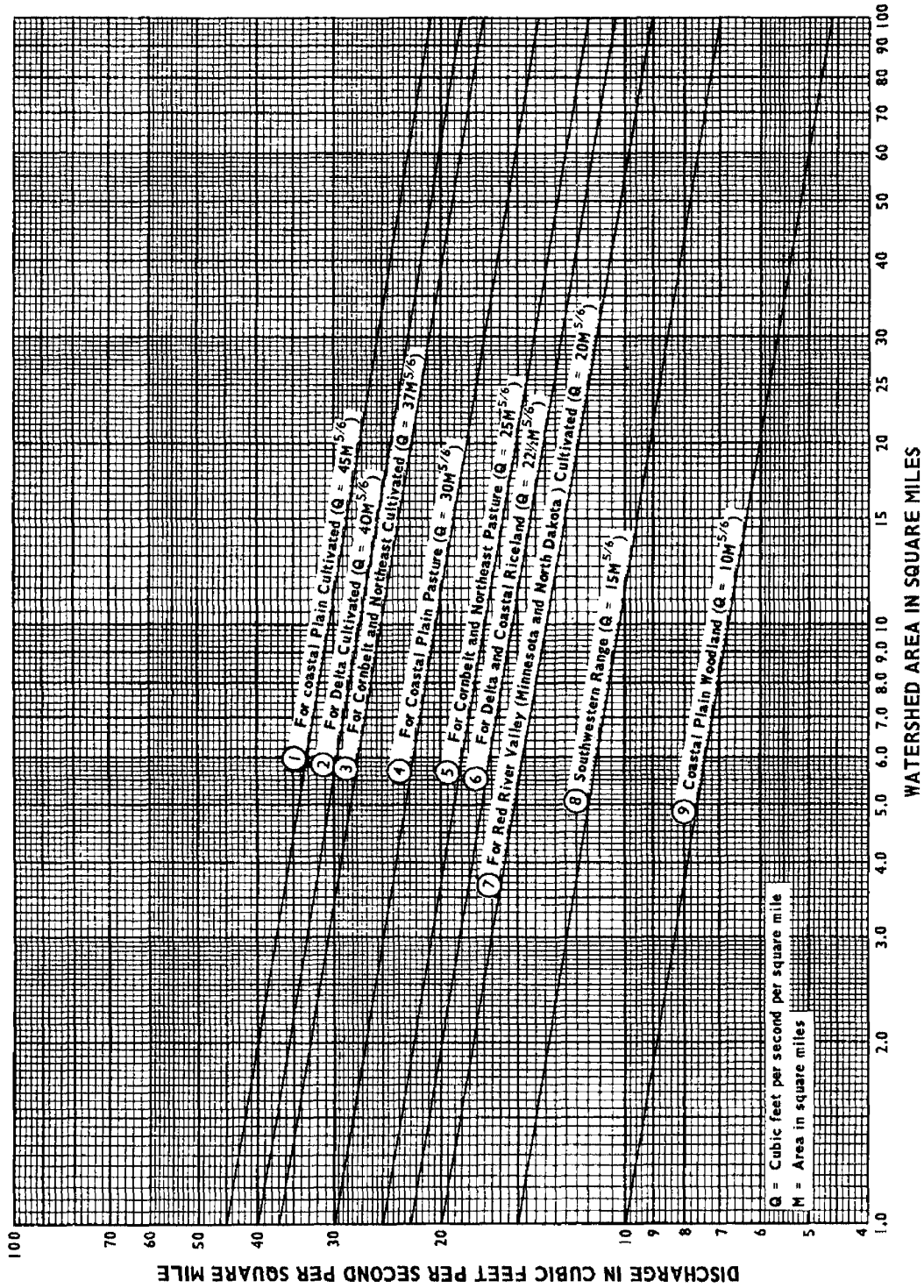

REFERENCE Curves 1, 2, 4, 6, 8 and 9 - Fort Worth, Texas and Spartanburg, South Carolina Engineering and Watershed Planning Units
 Curves 3 and 5 - John G. Sutton, "Hydraulics of Open Ditches," Agr. Eng., Vol. 20, No. 5, May 1939
 Curve 7 - Minnesota Dept. of Drainage and Waters

U. S. DEPARTMENT OF AGRICULTURE
 SOIL CONSERVATION SERVICE
 ENGINEERING DIVISION - DESIGN SECTION

STANDARD DWG. NO.
 ES-700
 SHEET 2 OF 3
 DATE 3-71

Figure 5-2, Drainage runoff curves

DRAINAGE RUNOFF CURVES

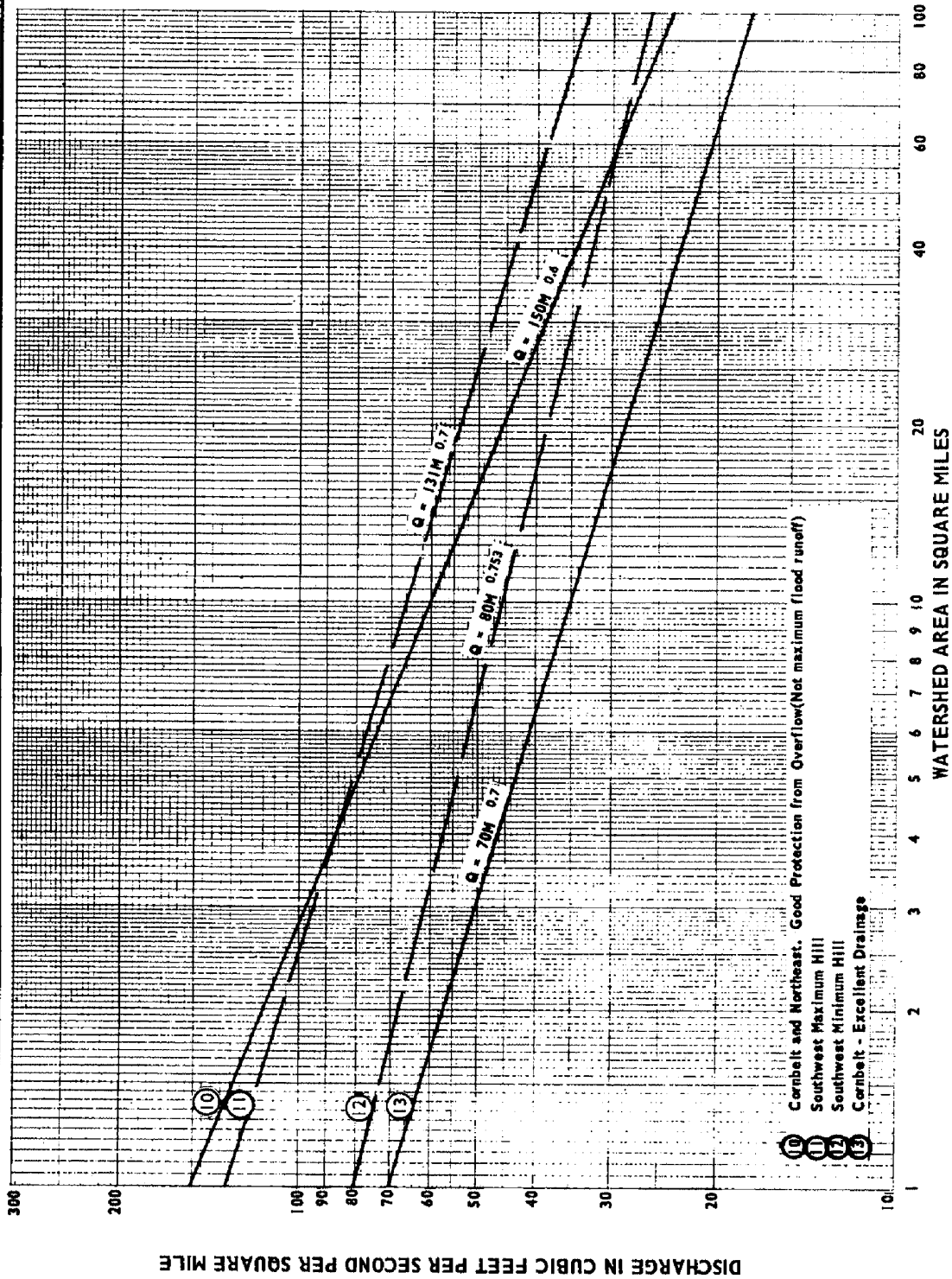

REFERENCE

Curves 10 and 13 - John G. Sutton, "Hydraulics of Open Ditches," Agr. Eng., Vol. 20, No. 5, May 1939.
 Curves 11 and 12 - Fort Worth, Texas Engineering and Watershed Planning Unit

U. S. DEPARTMENT OF AGRICULTURE
 SOIL CONSERVATION SERVICE
 ENGINEERING DIVISION - DESIGN SECTION

STANDARD DWG. NO.
 ES-700
 SHEET 3 OF 3
 DATE 3-71

Figure 5-3, Drainage runoff curves

**DETERMINATION OF THE COEFFICIENT C IN THE
DRAINAGE FORMULA: $Q = CM^{5/6}$**

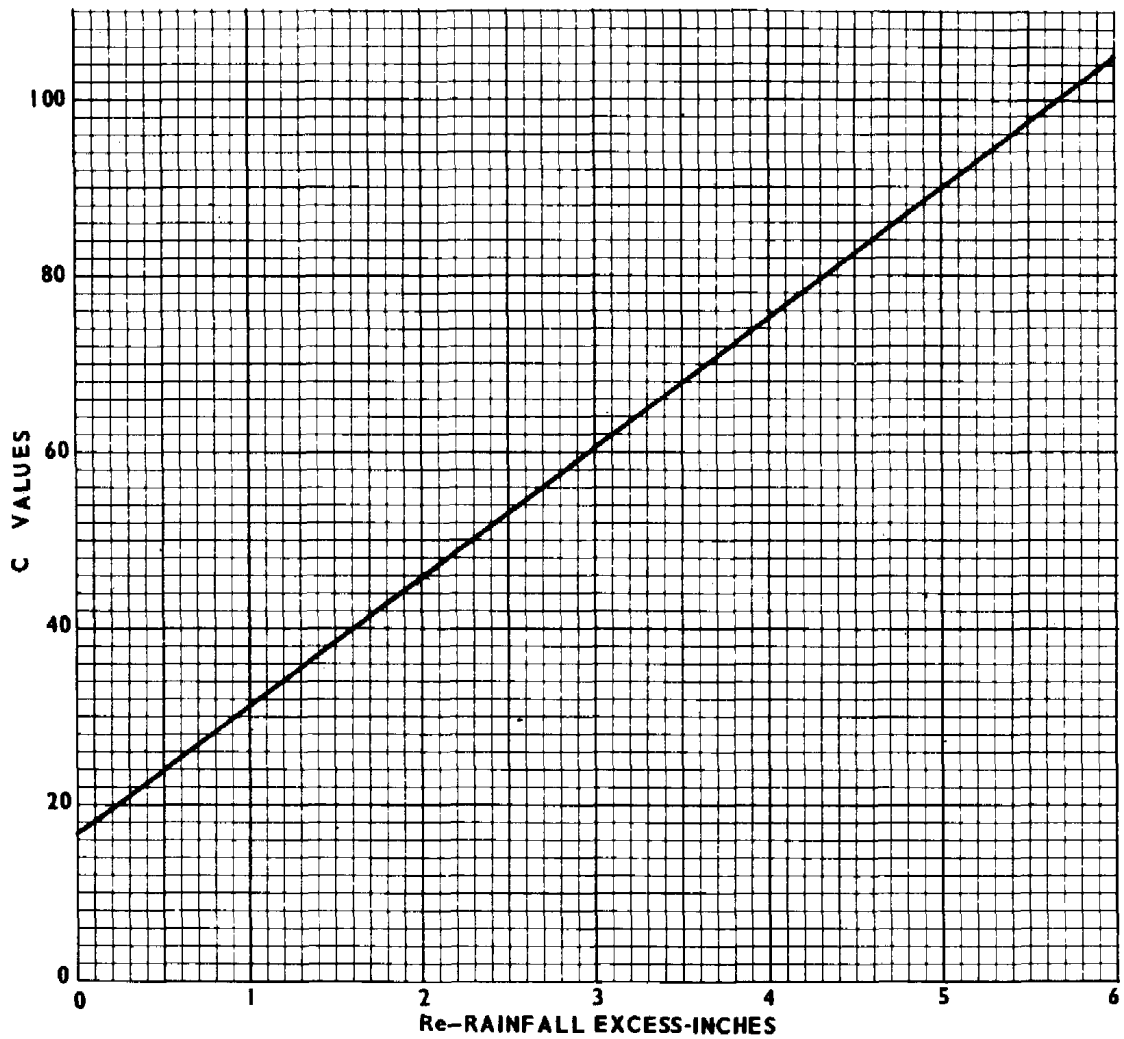

REFERENCE

Stephens, J. C. and Mills, W.C.
A.R.S. 41-95, USDA-ARS
 $C = 16.39 + 14.75 Re$

U. S. DEPARTMENT OF AGRICULTURE
SOIL CONSERVATION SERVICE
ENGINEERING DIVISION - DESIGN SECTION

STANDARD DWG. NO.

ES-733

SHEET 1 OF 1

DATE 3-71

Figure 5-4, Determination of coefficient, C, in the drainage formula: $Q = CM^{5/6}$

with coefficients in the range of 15 to 30 may provide adequate protection for the lower lying lands in a watershed and also provide a much higher degree of protection for lands which are a foot or two higher than the design hydraulic gradeline. In many watersheds, flood routing may be needed to determine the required channel size.

A common understanding of "24-hour removal" is that the rainfall excess from a particular storm is removed from the watershed within 24 hours after the cessation of rain. Actually, removal begins as soon as an excess develops. And since the critical storm for flatland areas may occur over an extended period of time - often 2 or 3 days - the analysis for determining the rainfall excess should be made by taking the maximum 48-hour rainfall for the recurrence frequency against which protection is desired, divide the excess from such a rain by two, and use this value in equation 5-2 to determine the coefficient for the surface drainage formula Eq. 5-1.

For general farm crops the level of protection normally planned is from a storm of 48 hours duration and with a frequency of occurrence of from 2 to 5 years. For high value crops with low tolerance to excess water, protection from the 10-year frequency storm may be desirable, or a special analysis may be warranted to remove, for example, the excess from a 24-hour rainfall in a 24- or 36-hour period. This will result in higher "C" values.

Example for computing "C" values. - Use of the above described procedure for computing a "C" value for the drainage formula first requires a decision on the level of protection to be provided the watershed. Then the characteristics of the specific watershed and the local climatic conditions must be considered. Assume that protection is to be provided against the maximum 48-hour storm of 5-year frequency. For example, U. S. Weather Bureau Technical Paper 49 shows that in southern Louisiana the 5-year, 2-day precipitation is about 8.0 inches. In this area the soil type places it in the D hydrologic soil group (see NEH 4, Chapter 7). Eighty percent of the area is in row crops having a runoff curve number 82 (contoured and terraced being used for flatland) and 20 percent is in permanent meadow having a runoff curve number of 78 (NEH 4, Chapter 9). This gives a weighted value of 81, which results in 5.74 inches of runoff for the 2-day storm (NEH 4, Figure 10.1). Use half of this or 2.87 inches in Equation 5-2 and obtain a value of 59 for "C" for use in the formula $Q = CM^{5/6}$.

Computation of design flow

The computation of the total design flow at a particular point on a ditch may involve combining the flow from tributaries or combining the flow from areas in the watershed on which different coefficients were used to compute the drainage flow. Methods used to combine flows from the various parts of any watershed should be directed to the objective of providing the desired protection for each part and for the watershed as a whole.

Combining flows from areas on which different coefficients are used to compute design flow

Within a particular watershed there may be sloping upland, flat bottom land, forest land, highly developed general cropland, or even some urban land. The characteristics of each distinct type of land and land use within the watershed determines the coefficient to be used in design of improvements on that parcel of land and in computing the drainage flow from it. In order to comply with one of the principles of the surface drainage formula: that the rate

of removal per unit of area varies according to the size of the drainage area, it is necessary to maintain the same relation of total flow to total area as the formula specifies. This can be done within tolerable limits by the simple device of determining the acreage of one type of land which by use of its proper coefficient will produce the same flow as a different acreage of another type of land using its proper coefficient. Then as the addition of flow proceeds downstream in a watershed each subsequent determination is based on the addition of area as well as water.

Drainage coefficients for steep and other areas

Where established drainage coefficients do not directly apply to steep and other areas, the drainage coefficient should be estimated after studying the following:

1. Determine the water tolerance of the predominant crops in the area and arrive at a time factor within which drainage should be provided. Determine depth of flooding permissible during this time.
2. Determine volume of runoff for the time period, determined according to item one, for rainfall to be expected in accordance with the level of protection planned. This may be a 48-hour rain to be expected once in 5 years for the first trial for general crops. For procedures to be used in computations see section on total storm runoff and peak flow and NEH 4.
3. Estimate the drainage coefficient from data obtained under items 1 and 2 from comparison with established drainage curves which apply to conditions most nearly similar.
4. Determine the hydrograph of runoff for the selected storm. Use this hydrograph to determine if the limits of permissible depth and time of flooding are exceeded with the channel capacity as estimated under item 3.
5. Adjust the drainage coefficient if results appear out of line with drainage requirements.

Where flow from a stream or channel, which carries runoff from hill land, enters a ditch designed on a drainage curve, the equivalent watershed area is computed and used in design as described on page 5-24.

Where protection of urban or other valuable property is required, the design of channels and other facilities should be based on holding depths of flooding to the level which can be tolerated in accord with the level of protection selected.

Determination of drainage coefficients for subsurface drainage is described in Chapter 4 of this handbook.

Total storm runoff and peak flow

In computing flow from steep or other areas where drainage curves are not applicable, the total volume of runoff and the peak flow need to be determined.

Volume of runoff. - For approximate results, the volume of runoff may be computed by the following procedures. These procedures are based on the use of

(a) U. S. Weather Bureau Technical Papers 40, 42, 43, 47, and 49, and (b) United States Department of Agriculture, Soil Conservation Service Engineering Handbook, Section 4, Hydrology.

The procedures described in NEH Section 4 should be used for computing volume of runoff based on soil-cover groups or complexes defined in the guide. Table 9.1 in the handbook prescribes curve numbers for various soil-cover groups and figure 10.1 (ES-1001) is a solution of the runoff equation for various curve numbers and amounts of rainfall. Hydrologic groups for various soils are given in table 7-1.

These procedures can be used to determine the volume of runoff from a storm of a specified duration and a given frequency.

The approximate total runoff may be computed as follows:

- Step 1. Determine watershed area and areas of parts of watershed in various soil-cover groups.
- Step 2. Select runoff removal time for drainage based on local crops and area to be protected. Normally the 24-hour duration storm is used.
- Step 3. Select rainfall intensity-frequency chart. Rainfall intensity-frequency charts in Weather Bureau Technical Bulletins, Paper 40, 42, 43, 47 or 49, whichever is applicable, should be used.
- Step 4. Determine rainfall to be used from the selected rainfall intensity frequency chart, according to the location of the job.
- Step 5. Select curve number to be used for each soil-cover group. Use Table 9.1, NEH 4, with antecedent moisture condition II for usual design.
- Step 6. Tabulate data in columns and compute total runoff.

List and description of columns needed:

- a. Area of each soil-cover group--
square miles (table 9.1, NEH 4)
- b. Land use or cover--row crops,
small grain, woods, etc. (table 9.1, NEH 4)
- c. Treatment of practice--straight
row, contoured, etc. (table 9.1, NEH 4)
- d. Hydrologic conditions, good
or poor (table 9.1, NEH 4)
- e. Hydrologic soil group, A,
B, C, or D (table 7.1, NEH 4)

- f. Curve No. (table 9.1 and figure 10.1, ES-1001), NEH 4, Hydrology
- g. Storm runoff in inches (from selected runoff curve number and rainfall as determined in step 4).
- h. Storm runoff from each soil-cover group obtained by multiplying column above by area square miles (result in inch-miles).

Step 7. Add column obtained in item h above to obtain total storm runoff from watershed in inch-miles.

Step 8. Divide by watershed area (square miles) to obtain volume of runoff in inches for watershed for storm period.

Example using the above procedure to determine the volume of runoff. - -

Step 1. The area for which the volume is to be determined is 5 square miles of flatland located where Texas, Arkansas, and Louisiana join. The runoff curve numbers and the soil cover groups as classified in table 9.1 are:

| C O V E R | | | | Hydrologic Soil Group | | | |
|-----------|-------------|-----------------------|----------------------|-----------------------|----|----|---|
| Land Use | Area Sq.Mi. | Treatment or Practice | Hydrologic Condition | A | B | C | D |
| Row crops | 2.0 | Contoured | Good | | 75 | | |
| Row crops | 1.0 | Contoured | Good | | | 82 | |
| Pasture | 1.0 | | Fair | | | 79 | |
| Woods | 1.0 | | Poor | | 66 | | |

Step 2. The time established to drain the composite area is 24 hours.

Step 3. A 24-hour, 5-year storm is selected.

Step 4. Using Weather Bureau Technical Paper 40, the rainfall from a 5-year, 24-hour storm in the area is 5.8 inches.

Step 5. The curve numbers to be used for each soil cover group using hydrologic condition II are selected from table 9.1 and are shown in step 1 under Hydrologic Soil Groups.

Step 6. Using rainfall determined in step 4 the total runoff is determined from ES-1001 as follows:

| <u>Curve No.</u> | <u>Runoff, inches</u> | <u>Area, sq.mi.</u> | <u>Inch Miles</u> |
|------------------|-----------------------|---------------------|-------------------|
| 75 | 3.11 | 2 | 6.22 |
| 82 | 3.80 | 1 | 3.80 |
| 79 | 3.50 | 1 | 3.50 |
| 66 | 2.29 | <u>1</u> | <u>2.29</u> |

Step 7. Total 5 15.81

Step 8. Inches per square mile $\frac{15.81}{5} = 3.16$ inches.

Peak runoff and hydrographs. - The peak runoff may be estimated by one of the methods described in NEH 4. The method to be used depends upon the accuracy and expense justified in making the required determination. NEH 4 discusses both approximate and detailed methods of estimating peak runoff and construction of hydrographs.

Design Standards

Requirements for side slopes, berm widths and maximum velocities of drainage ditches are based primarily on water table elevations, soil conditions and maintenance requirements. These and other design standards are established in most State handbooks and local drainage guides.

Channel design

Determination of required channel dimensions for a given rate of flow (Q), hydraulic gradient (s), and channel roughness (n) is usually made by a solution of the Manning equation to determine the mean velocity (v) and by use of the relation: $Q = Av$ where Q = rate of flow in cubic feet per second, A = cross-sectional area of the channel in square feet. The Manning equation is usually written:

$$v = \frac{1.486}{n} r^{2/3} s^{1/2} \quad \text{Eq. 5-3 (2)}$$

- v = mean velocity of water in feet per second
- r = mean hydraulic radius in feet - cross-sectional area of the channel divided by its wetted perimeter
- s = the energy loss per foot of length and for open channels with very small slopes it may also be defined as the slope of the energy gradient. For uniform flow, s is also the drop in the channel per foot of length, and for very small slopes it becomes nearly equal to the slope of the channel.
- n = coefficient of roughness for use in the Manning equation.

Value of "n" for design

The proper design of a ditch requires the selection of the value of "n", the coefficient of roughness that will exist after it is in use and well maintained. A useful guide for the selection of "n" for the design of drainage ditches is given in table 5-2.

Table 5-2.--Value of "n" for drainage ditch design

| Hydraulic radius | "n" |
|------------------|---------------|
| less than 2.5 | 0.040 - 0.045 |
| 2.5 to 4.0 | .035 - .040 |
| 4.0 to 5.0 | .030 - .035 |
| more than 5.0 | .025 - .030 |

These values are an interpretation of results reported in United States Department of Agriculture Technical Bulletin 129, Flow of Water in Drainage Channels, 1929. (Also refer to the U. S. Department of Agriculture, Soil

Conservation Service, Engineering Handbook, Section 5, Hydraulics, Supplement B.) Values here are based on the assumption that obstructing vegetation in channels will be kept down by maintenance. If vegetation is not kept down, the value of "n" may be 0.100 or higher.

In newly excavated channels the values of "n" are lower and velocities higher than design values. Where the design velocity is near an erosive value, this may need to be studied and corrective measures planned. The velocity may be lowered within narrow limits by making a ditch wider and shallower. Excavation may be planned during the growing season and banks may be seeded to avoid exposure of raw banks unnecessarily.

Channel section

The channel section selected should be (a) large enough to permit the required discharge, (b) as deep as required to provide a satisfactory outlet for both surface and subsurface drainage needs of the area served, and (c) of a width-depth ratio and side slopes which will result in a stable channel which can be maintained in a satisfactory condition at a reasonable cost.

Depth. - The minimum depth of ditches acting as disposal ditches for subsurface drains unless otherwise specified, should be about 5 feet in the humid area and 8 feet in western irrigated areas. Drainage guides should specify depth standards.

Bottom width. - Capacity required, soil materials, velocity and the type of construction equipment to be used are factors which affect the minimum bottom width which should be planned. Excessively wide and shallow ditches are not hydraulically efficient and are usually more difficult to maintain than are ditches with a more efficient hydraulic section.

Side slopes. - Side slopes to be recommended for local site conditions should be specified in drainage guides for the area. The side slope of old ditches should be examined to determine their stability in the usual soil types.

Maintenance requirements also should influence the selection of side slopes. Ditch side slopes which may be used with various maintenance methods are given in table 5-3.

Table 5-3.--Ditch side slopes for use with various maintenance methods

| Type of Maintenance | : Usual : Recommended : Minimum : Side Slopes | : R e m a r k s |
|---------------------|--|---|
| Mowing | 3:1 | Flatter slopes desirable for ordinary farm wheeled tractors. Special equipment may be used on steeper slopes (see p. 5-50). |
| Grazing | 2:1 or flatter 1/2:1 or flatter | For ditches greater than 4 feet deep, use ramps. For ditches less than 4 feet deep, use ramps. |
| Dragline | 1:1 | Suitable for use in stable soils on ditches greater than 4 feet deep. |
| Blade equipment | 3:1 | Flatter slopes desirable. |

In locations, where field laterals are used for subsurface drainage, the deep ditches require so much right-of-way that ditchbanks need to be constructed with side slopes as steep as possible to conserve land. Such ditches may justify an on-site study to determine the natural angle of repose of the soil and to observe old ditches, so that stable side slopes can be determined. Water must not be allowed to run over the banks of the deep ditches.

Stability of bank slopes on noncohesive soils such as fine sands are usually not obtained immediately after initial excavation because of sloughing from seepage before the normal water table recedes to new levels. Construction procedure may require an early followup to reshape the banks. It may be desirable on some jobs to require initial excavation of a pilot channel of lesser width than the designed section and later completion of the excavation and the shaping of the banks. This will allow the water table to become adjusted to the deeper ditch before the final shaping.

Ditch stability. - The velocity selected for the ditch design may be acceptable for the depth of flow and the condition expected after the channel has aged but the velocity must be also satisfactory for bank-full flow and the conditions which will exist immediately after construction. Bank-full flow is the flow that will create a water surface at or near the normal ground elevation for a significant length of a reach of the ditch. Excess ditch depth resulting from a cut through high ground is not considered.

Recommended procedures for designing stable channels are given in SCS, Engineering Division, Technical Release No. 25, Planning and Design of Open Channels.

Berms and spoil banks. - Adequate berms are required to:

1. Prevent sloughing of ditchbanks caused by heavy soil loads too near the edge of the ditch.
2. Provide travelways for maintenance equipment.
3. Eliminate the need for moving spoil banks in future operations.
4. Provide for work areas to facilitate spoil bank spreading.
5. To prevent excavated material from washing or rolling back into ditches.

If the spoil banks are to be spread the berm required during construction and the method of spreading the spoil need to be specified in the construction contract. The best use of the spoil and how far it can be spread are determined by the type of excavated soil, the adjacent land use, the need for roads, and the method of maintenance to be employed. In some locations spoil can be shaped and used to good advantage for farm roads. In all cases a travelway should be established on the berm or on the spread spoil which is adequate for movement and operation of the type of equipment needed for maintenance of the ditch.

In humid areas, the spoil banks usually should be spread so they can be cultivated or kept in hay or pasture. The spoil should be spread to slope away from the ditch and left so ordinary farm equipment may operate over the spoil.

Spoil banks should not be spread where infertile soils, rock, gravel, or irrigation practices do not permit cultivation of spoil material, or where they will be covered with timber or brush. Where not spread, the spoil bank should be in as small a right-of-way as possible consistent with berm requirements, and side slopes should be as steep as the soil permits. Where unproductive soils occur at lower depths in large ditches, the good soil should be segregated during construction, and then spread to use it to better advantage. Fertile spoil may be used for land grading, smoothing, or land leveling in adjacent fields or as topsoil of the spoil banks.

Safe entry of surface water through the spoil into the ditch should be provided. In placing and spreading the spoil, points of entry and type of inlet structure to be used need to be determined.

Spoil material should be disposed of in a manner which will improve the esthetic appearance of the site to the extent feasible.

In areas where soils and climatic conditions are favorable, planting of hay or pasture crops on berms, travelways and spoil disposal areas is good practice. On suitable sites, plantings should be made for shelter and food for wildlife. When the plan provides for planting trees or shrubs along a ditch the plantings should be placed so that they will not interfere with channel flow, maintenance operations, or the maintenance travelway.

Local technical guides should recommend desirable types of vegetation and methods of establishment since vegetation is of primary importance in reducing maintenance and preservation of wildlife.

Design Procedure

General

The basic procedure for drainage ditch design includes the following:

1. Check all basic field information such as field elevations, control points, soil borings, bridge footing, etc. for completeness. Also check the elevation of the water in the outlet. A stage-frequency curve should be obtained wherever possible.
2. Establish control points and set hydraulic gradeline for design.
3. Determine watershed areas and equivalent watershed areas if required at the lower ends of selected design reaches.
4. Compute design discharge in c.f.s. for the lower end of each reach.
5. Select and record appropriate design criteria including values of "n", side slopes, minimum bottom width, and minimum depth below hydraulic gradeline.
6. Design ditch section below the established hydraulic gradeline.

In applying this procedure several problems arise such as combining flow from different types of watershed areas and at junctions of ditches, at culverts and bridges. This chapter discusses methods of handling these situations.

Drainage ditches should be designed to pass the design drainage flow throughout the length of the ditch with the hydraulic gradeline sufficiently below the elevations of land to provide good drainage. The hydraulic gradeline represents the surface of the water when the ditch is operating at design flow. Its slope "s" is used in the Manning formula to determine velocity. The grade of the ditch bottom may have a different value because the ditch bottom is not always parallel to the hydraulic gradeline.

Uniform flow is ordinarily assumed in the design of drainage channels except above culverts and at locations where the design requires backwater computations. With these exceptions the ditch bottom may be established parallel to the hydraulic gradeline and a uniform channel section used. Even though non-uniform flow results where minor obstructions occur or where minor local drainage enters it is of little practical significance and the general efficiency of the system is not impaired.

The Manning formula is recommended for open-ditch design because of its simplicity and range of tables available. The Corps of Engineers publication, Hydraulic Tables, permits an easy and rapid solution of the Manning formula for values of "n" from 0.010 to 0.175. These tables may be bought from the United States Government Printing Office, Washington, D. C. 20401.

Establishing the hydraulic gradeline

The hydraulic gradeline is established after determining land use, the elevation of control points along the ditch, and plotting the control points on the ditch profile. Usually control points are established below the elevation of principal fields so they can be adequately drained and at hydraulic gradelines of lateral ditches or streams entering the ditch. Where it is impractical to establish control points low enough to drain the land, the land use may need to be adjusted to more water-tolerant crops, such as pasture or trees. The control points are established low enough to allow for headloss by surface flows from the field through the bottom of the row furrows and surface drains to the outlet.

Additional control points are determined from culverts, bridges, buildings, roads, and other property within the area to be drained. The hydraulic gradeline is drawn through or below as many control points as possible based on their importance and after studying (a) the profile of the natural ground surface, (b) critical elevations established by surveys, and (c) channel obstructions such as culverts and bridges.

The hydraulic gradeline often is drawn above some control points to save excavation. The importance of control points depends on the agricultural area or property values they represent and on the extent and results of poor drainage if the hydraulic gradeline is above the control point. All control points representing the elevations of the hydraulic gradeline of lateral ditches must be established and used in drawing in the hydraulic gradeline of the main ditch. The hydraulic gradeline of the main and all laterals should coincide at points of intersection before the ditch sections are designed.

Where the hydraulic gradeline needs to be established above the levels of low-lying land, such land will not receive the same degree of drainage benefit as fields lying above the hydraulic gradeline. This may limit the land use of lowland to crops such as hay, pasture, or woodland. Lower drainage assessments may need to be placed because of the limitations in land use. Establishing the

best hydraulic gradeline for good economical drainage requires practical experience. Perfection in this should be a major goal of a drainage engineer. Drawing a line through the control points on the profile fixes the hydraulic gradeline. It will often need to be drawn more than once to obtain the best balanced results.

The design of a drainage system may begin at either the upstream or downstream end. The elevation of the hydraulic gradeline for the lowest design reach needs to be at the controlling elevation of the outlet. For many ditches, it makes little difference where the design commences. Where there is limited grade it may be necessary to use bridges in lieu of culverts to minimize head loss at structures.

Computing ditch sizes at junctions - 20-40 rule

One method of computing the required capacity of a ditch below a junction is to add the design flows (c.f.s.) of the two ditches above the junction. A second method is to add the tributary areas of the two ditches and compute the size based on the drainage coefficient for the total watershed area. The first method gives a higher discharge than the second method. Method 1 should be used where ditches draining almost equal areas join. Here the time of concentration is likely to be about the same if topography is the same and peak flows ordinarily will reach the junction at about the same time. Method 2 is used where the ditch draining a small area joins a ditch that is much larger. This is because the peak discharge from the small ditch passes before the peak flow of the larger ditch reaches the junction. For intermediate conditions a transition from one method to the other should be applied.

A recommended method for determining the design discharge below a junction is by use of the following empirical procedure termed the 20-40 rule:

1. Where the tributary area of one of the ditches is from 40 to 50 percent of the total tributary area, determine the required capacity of the channel below the junction by adding the required design capacities of the ditches above the junction.
2. Where the watershed area of a lateral is less than 20 percent of the total watershed area, determine the design capacity of the ditch below the junction from the drainage curve and for the total watershed area below the junction at the end of the design reach.
3. Where the watershed area of a lateral is in the range of 20 to 40 percent of the total watershed area, the discharge shall be proportioned from the smaller discharge obtained by use of method 2 at 20 percent to the larger discharge obtained by use of method 1 at 40 percent. In this range compute the discharges by both methods 1 and 2 above and obtain the difference in cfs by the two methods. Then interpolate to obtain the design discharge for the channel below the junction.

Illustrating this, assume that a lateral draining 3,200 acres joins an outlet draining 10,200 acres above the junction with 13,400 acres watershed area below the junction. A curve developed from the formula $Q = 45 M^{5/6}$ is to be used to calculate runoff. Since the watershed area of the lateral is between 20 and 40 percent of the total watershed, the flow will be computed as follows:

| | | |
|---------|---|-------------------|
| Step 1. | Runoff from 3,200 acres | 170 c.f.s. |
| | Runoff from 10,200 acres | <u>460</u> c.f.s. |
| | Total discharge from the two watersheds | 630 c.f.s. |

| | | |
|---------|--|-------------------|
| Step 2. | Runoff from total watershed 13,400 acres | <u>580</u> c.f.s. |
|---------|--|-------------------|

| | | |
|---------|---------------------------------------|-----------|
| Step 3. | Subtract step 2 from step 1 | 50 c.f.s. |
|---------|---------------------------------------|-----------|

Step 4. Percent of small watershed (3,200 acres) of total watershed

$$(13,400 \text{ acres}) \text{ is } \frac{3200}{13400} \times 100 = 23.8 \text{ percent.}$$

Step 5. Difference between 23.8 and 20 = 3.8.

Step 6. $\frac{3.8}{20} \times 100 = 19 \text{ percent.}$

Step 7. From step 3, $50 \times 19 \text{ percent} = 9.5.$

Step 8. Add 580, from step 2, and 9.5, from step 7 589

This is the final interpolated discharge from this watershed below the junction.

NOTE: Computations in method 2 assume a short design reach below the junctions with no increase in watershed area below the junction. Often the design reach may be long enough to require an added discharge from the area below the junction.

If the 20-40 rule increases the ditch section above normal for the watershed, the enlarged section is carried downstream without changing size until additional watershed requires a larger ditch section based on total watershed area.

In the example of design, figure 5-9 and table 5-4, method 3 is illustrated at station 360+00 where lateral A has a watershed of 37.5 percent of the total and the design discharge is obtained by interpolation. Laterals B, C, D and E have watershed areas less than 20 percent of the total watershed area below the respective junctions. Here, method 2 with design Q based on watershed areas below the junction applies.

Computing equivalent drainage area

When runoff is removed at different rates on various parts of the watershed it will be necessary to find either equivalent areas or equivalent discharge so the correct design capacity can be carried downstream without confusion. This can best be done by compiling drainage coefficient curves based on total discharge for the area rather than by discharge per square mile. Such curves are shown in figure 5-5. Equivalentents can be read directly from these curves.

Example of use: (based on figure 5-5)

2,000 acres of land requiring the curve developed from $Q = 45 M^{5/6}$ joins
 1,000 acres of land requiring the curve developed from $Q = 22\frac{1}{2} M^{5/6}$

It will be necessary to convert to either $Q = 45 M^{5/6}$ or $Q = 22\frac{1}{2} M^{5/6}$

DRAINAGE RUNOFF CURVES FOR SAMPLE DRAINAGE DITCH DESIGN

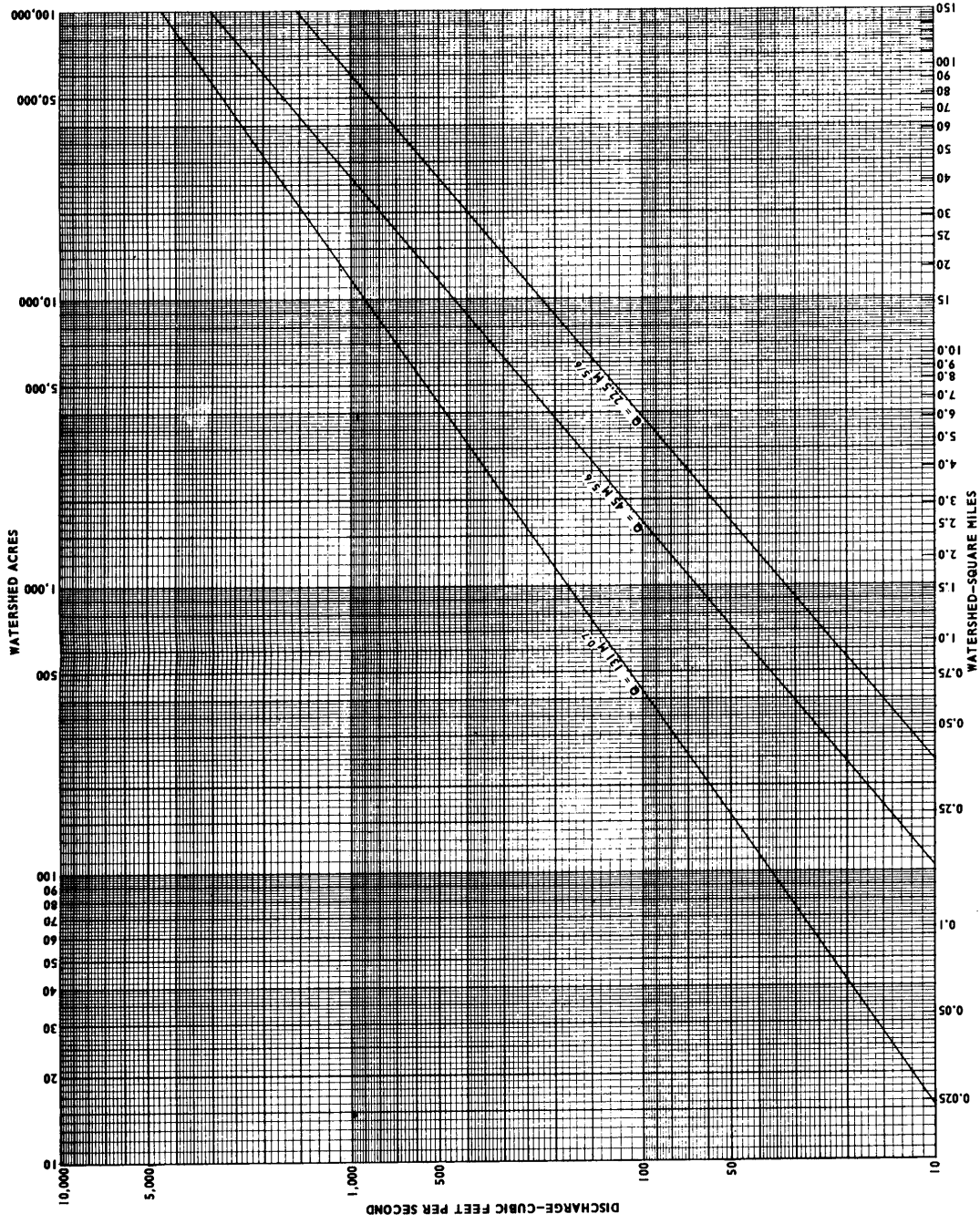

REFERENCE

DRAINAGE DESIGN PROBLEM CHAP. 5, SEC. 16

U. S. DEPARTMENT OF AGRICULTURE
SOIL CONSERVATION SERVICE
ENGINEERING DIVISION - DESIGN SECTION

SHEET 1 OF 1
DATE 9-71

Figure 5-5, Drainage runoff curves for sample drainage ditch design

Figure 5-5, Drainage runoff curves
for sample drainage ditch design

depending on the use below the junction. This is found to be predominantly land use requiring runoff removal rate of $Q = 45 M^{5/6}$. The discharge from 1,000 acres on $Q = 22\frac{1}{2} M^{5/6}$ is 32.5 c.f.s. This is equivalent to 425 acres on the $Q = 45 M^{5/6}$ curve. Hence, we would assume a total watershed below the junction of 2,000 acres plus 425 acres which equals 2,425 acres. The total discharge from 2,425 acres on the $Q = 45 M^{5/6}$ curve (considering the 20-40 rule given on page 5-23) is found to be 140 c.f.s. Therefore, 140 c.f.s. is the design flow below the junction.

Flow from reservoirs into drainage systems

In most situations the flow from flood-prevention reservoirs may be handled in drainage design by subtracting the watershed area upstream from the dam from the total watershed area and adding the outflow through the principal spillway. The outflow should be added as a constant flow to the drainage flow computed from the watershed below the dam. The effect of weir-type dams may be disregarded under most conditions and the drainage design based on the entire watershed area contributing to the channel.

The effect of flood-prevention reservoirs may be disregarded, for drainage-design purposes, at some point downstream. This point may be determined by figuring the average outflow of the reservoir in c.f.s. per square mile of watershed area above the dam. If this rate of flow is below the minimum rate in the drainage curve applicable at the outlet and based on the entire watershed area, the reservoir affects the entire drainage system. If the rate of outflow from the reservoir intersects the drainage curve, the effect may be disregarded for drainage-design purposes below the point and watershed acreages considered as if no dam existed.

For example, the principle is illustrated by the following problem: Assume a reservoir with a single stage principal spillway has a drainage area of three square miles. The channel below the structure will be designed using drainage curve No. 5, figure 5-2. The average outflow from the reservoir during 24 hours is computed at 14 c.f.s. per square mile or 42 c.f.s. The average outflow is approximately 80 percent of the maximum principal spillway outflow. Drainage curve No. 5 at a watershed area of 30 square miles gives a flow of 14 c.f.s. per square mile.

Therefore, economy in drainage design is obtained by considering the reservoir effect in designing the drainage channel between the reservoir and the point where the total watershed area equals 30 square miles. In this stretch the watershed area above the reservoir equaling 3 square miles should be deducted and the flow of 42 c.f.s. should be added for the drainage channel design. Below this point where the total watershed reaches 30 square miles it would be economical here to disregard the reservoir effect and design the channel based on the total watershed area.

Hydraulic design at culverts

Culverts usually obstruct the flow of water in ditches and cause a loss in head. This must be accounted for in designing drainage ditches. Figure 5-6 gives the steps applicable for designing most drainage ditches at culverts. With this, the hydraulic gradeline is set low enough at the culvert to compensate for loss in head through the culvert unless local land use will permit flooding. If the permissible culvert loss (2-3) is computed correctly (NEH, Section 5, Hydraulics) and other steps are followed, the profile of the water

surface will be about the backwater curve (2-6) and well within bank capacity during the design-drainage flow.

Ordinarily precise computations of backwater curves at bridges and culverts need not be made where only agricultural drainage is considered.

In applying the method in figure 5-6, control point 1 should be established. This point should be far enough upstream from the culvert to make the difference in elevation between 1 and 8 at least twice the loss of head at the culvert (2-3).

For low gradient channels, less than 5 feet per mile, computations indicate the backwater curve may be as much as 0.2 or 0.3 foot above point 1 if distance 1-8 is twice the culvert loss 2-3 for typical drainage ditches. If there are bridges, culverts, or obstructions in the stretch 1-2 or if a hydraulic gradeline a few tenths above point 1 for design flows would be serious, then a backwater curve should be computed by the simplified method given in NEH, Section 5, Hydraulics, Supplement A.

Many highway departments have specified methods of computing their culvert capacities. Culvert capacities may be based on peak-flood flows determined for specific frequencies or by a designated method of estimating runoff. Where a peak flood for a 5- to 10-year, or longer, frequency is used as a basis for design of channel capacity without flooding and where the depth is adequate, the culvert will ordinarily be ample for agricultural drainage.

The permissible culvert head loss depends on grade of ditch, erosion, land use, and other local conditions. Culverts not governed by more exacting highway requirements should meet one of the following conditions:

1. In large outlet ditches on flat slopes, a culvert may obstruct flow seriously if not properly designed. Keep the hydraulic losses as low as possible. Generally such losses should not exceed 0.5 to 1.0 foot. Check for excessive velocities through the culvert. Excess velocity on the outlet end will cause serious erosion problems.
2. Where the ditch has excess grade, grade control may be incorporated in a culvert.

Allowable culvert losses may be increased depending on drainage requirements. However, avoid excessive velocities. Often culvert losses of as much as 2 feet are permissible but higher losses need to be studied with care. Where needed, provide downstream protection against erosion due to high velocities. A self-cleaning velocity also may be an advantage for culvert maintenance if protection is provided against erosion.

3. In important installations, make channel routing and determine hydrographs, amounts of storage, and estimates of height and duration of flooding caused by floodflows in excess of drainage flow. The importance of the highway, size and value of culvert, value of land, crops to be grown, flood damages incurred, and drainage-design factors all need to be accurately determined for design of important structures obstructing flow.

PROCEDURE FOR DESIGN OF DRAINAGE DITCHES AT CULVERTS

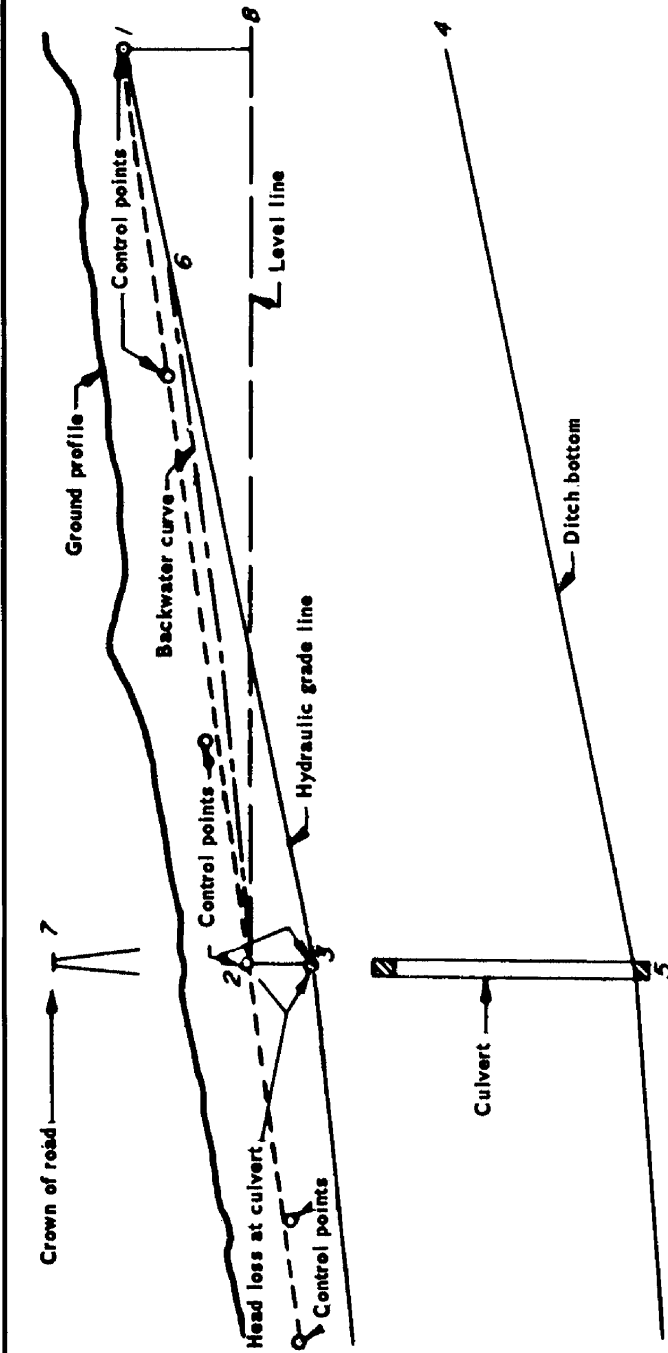

- a - Set "control points" 1, 2, etc. as though no culvert is to be installed. Compute head loss at culvert 2 to 3; measure down from upper "control point" 2 at culvert and set lower "control point" 3. Make distance 2 to 8 large enough so that 1 to 8 is two or more times greater than 2 to 3. Point 1 is approximately at limit of backwater curve which may be established by standard methods of computing backwater curves.
- b - Normal hydraulic gradient would be line 1 to 2.
- c - Draw hydraulic gradient for ditch section above culvert from "control point" at 1 to lower "control point" at 3.
- d - Compute ditch section required based on drainage flow and hydraulic gradeline 1 to 3 and set ditch bottom 4 to 5.
- e - Culvert will cause heading-up along typical backwater curve 2 to 6; generally close to line 1 to 2, provided 1 is far enough upstream.
- f - Check floodflows over crown of road depending on elevation at point 7.

REFERENCE

U. S. DEPARTMENT OF AGRICULTURE
SOIL CONSERVATION SERVICE
ENGINEERING DIVISION - DESIGN SECTION

STANDARD DWG. NO.

ES-709

SHEET 1 OF 1

DATE 3-71

Figure 5-6, Procedure for design of drainage ditches at culverts

In installing culverts, carefully check the elevation of the crown of the road to be sure the road is well protected against overtopping. Bypassing flood-flows over low stretches of roadways serving as spillways may need to be provided for farm roads.

Flooding, caused by water impounding back of a culvert during excessive flows, frequently influences land use. Land use above a culvert may have to be restricted to water-tolerant crops or pasture. Cultivation of truck and other crops susceptible to large damage by flooding may need to be avoided. Here, installing a bridge instead of a culvert or enlarging a culvert to reduce flooding may be required.

The upstream end of the culvert should have a rounded entrance. This type of entrance greatly reduces the entrance losses and results in a much more efficient structure.

Principles of computing culvert losses are discussed in NEH, Section 5, Hydraulics, King and Brater's Handbook of Hydraulics (2), and the Bureau of Public Roads Hydraulic Engineering Circular No. 5 (3).

Hydraulic design at bridges

Bridge openings should have as near the required cross-sectional area of the ditch as possible. Center piers should be avoided if possible in preference to side abutments. Upstream faces of piers and foundation walls need to be rounded to reduce friction loss and obtain streamline flow. The stringers of the bridge should be set above the probable flood height to avoid collecting debris as well as for the safety of the bridge. (Photographs page 5-31.)

Significant losses in head at bridges are estimated and taken into account in design. Serious losses may occur if bridges are close together and restrict the flow. A ditch design that fails to take care of such losses may be inadequate.

The following references should be consulted in determining losses in head due to bridges and trestles in drainage channels and floodways:

- Pile Trestles as Channel Obstructions, D. L. Yarnell (4)
- Bridge Piers as Channel Obstructions, D. L. Yarnell (5).

Computing cross section of ditch

Where the cross section of the ditch is based on the required quantity of flow the cross-sectional area is determined from the formula:

$$Q = av$$

where Q = design capacity in c.f.s.

a = cross-sectional area of ditch below the established hydraulic gradeline in square feet.

v = mean velocity of flow, feet per second, usually computed by use of the Manning formula and the Corps of Engineers' Hydraulic Tables or King and Brater's Handbook of Hydraulics.

In addition to the factors discussed under channel section, page 5-19, the following factors should be considered by the designer in adjusting depth,



Piers are placed on each side of ditch bottom

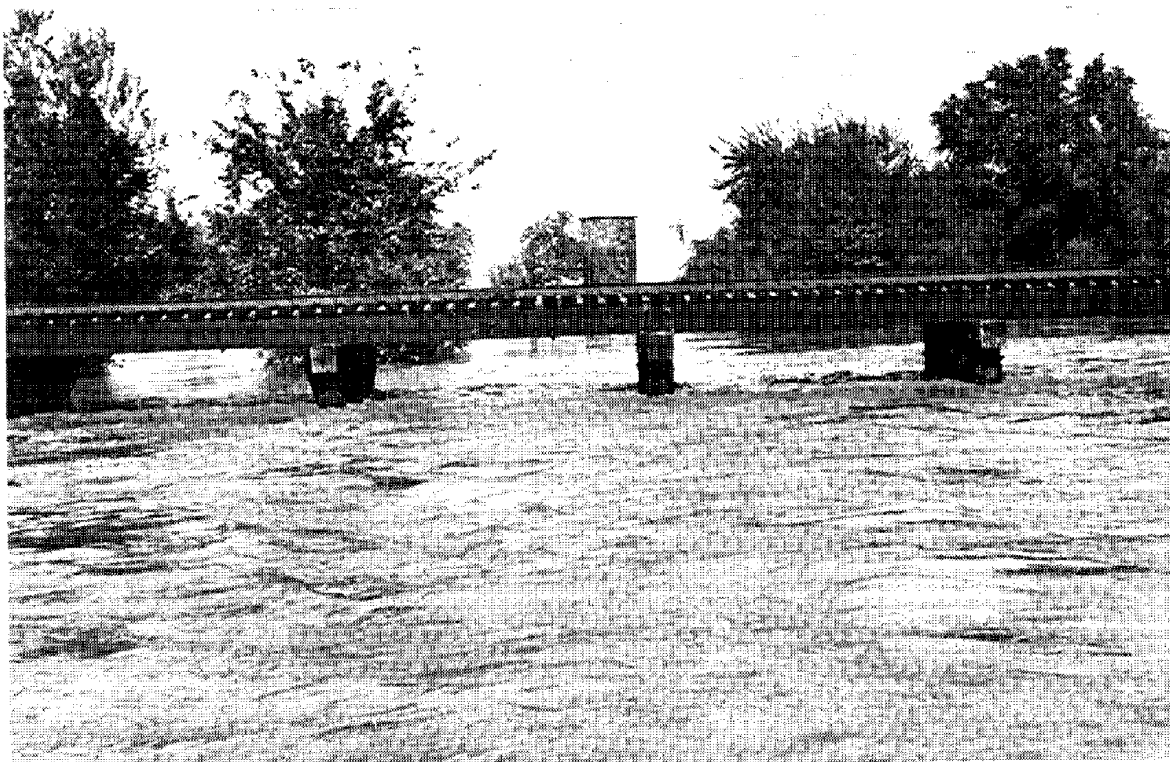

Stringers are set above the probable flood height

bottom width, and side slopes to obtain the required cross-sectional area:

1. A deeper ditch gives a higher velocity than a shallow one.
2. A deeper ditch may provide a better opportunity for future subsurface drainage in the drainage area.
3. A deeper ditch requires less right-of-way than a shallow ditch.
4. A deeper ditch may uncover unstable layers of soil which a shallow one would not.
5. A shallow ditch may be more practical to maintain by pasturing or by mowing flat side slopes.

Allowance for initial sedimentation

It is good practice to allow for initial sedimentation in a ditch during the first 2 or 3 years after construction. This allowance is to obtain the designed capacity after the ditch stabilizes and is provided by increasing the design size. The amount of this allowance depends on the erosion from adjoining lands, the erosiveness of soils exposed in the ditch, and the sediment from laterals and tributaries. The principal sources of sediment usually are the raw ditchbanks containing sand and silt, cultivated fields, and silt-carrying tributaries. After ditchbanks are stabilized by vegetation, sedimentation decreases.

Various practices in use to take care of initial sediment include the following:

1. Provide increase in depth or bottom width but no increase in top width.
2. Overexcavate the ditch (in depth only) as a construction practice. In some locations this may average 6 to 12 inches and is included in the quantities paid for.

Establishing bottom grade of ditch

The following should be determined in establishing the bottom grade of the ditch:

1. Locate the ditch bottom deep enough so that buried drains can outlet above the expected low flow. The invert elevation of the drains should be at least 1 but preferable $1\frac{1}{2}$ feet above the ditch bottom. Where the bottom grade of the ditch will remain stable the local drainage guide may specify a clearance of less than 1 foot below the invert of the drain. Allow sufficient depth for sediment to accumulate so that a free outlet is possible for at least 10 to 15 years before reconstruction. Too often ditches are designed with little or no thought given to this. Frequently, during the first two years, the bottom grade is raised so much through accumulation of sediment that drains are adversely affected.
2. In arriving at the required depth to provide good drainage, determine the elevation of the distant low areas. Compare this with the

elevation of the hydraulic gradeline at the point where the low area will drain into the outlet. Then starting at the low area with sufficient depth below the hydraulic gradeline for drainage of that area, project a reasonable grade for an open ditch or drain to the outlet ditch. The required elevation of the bottom of a lateral needed to provide drainage for the distant low area can then be determined.

3. To obtain greater capacity at critical points, such as junctions, increase the depth and/or width of the ditch for design purposes. Avoid actual abrupt change in grade by constructing the ditch bottom upstream at a grade which will not result in erosion. A grade-control structure may be required to stabilize the grade if erosive soil, such as loess, is involved.
4. Show the bottom grade on the profile in percent and show the slope of the hydraulic gradeline on the profile as the tangent of the slope.

Design of large open-ditch system

An example of procedures used in the design of a large open ditch is shown in figure 5-7 and in table 5-4.

Figure 5-7 shows the schematic layout of the ditch system. The watershed areas at the upper and lower end of each section and at intermediate points as required are noted. These areas should be determined from maps or surveys.

On large drainage jobs of this kind it is desirable to plot a condensed profile (figure 5-7). For preliminary surveys, elevations of the ground level at 500 feet to half-mile intervals may be used. The low elevations of the fields to be drained and other points should be shown on the profile.

The design and numbering of the ditch may begin at either the upstream or downstream end. The practice used locally by private engineers or drainage districts for numbering sections should be followed since such plans may be used in legal proceedings. In the example (figure 5-7) the station numbering starts at the lower end. The computation of watershed areas and equivalent areas should proceed from the upper end toward the outlet. The elevation of the water in the outlet controls the elevation of the hydraulic gradeline of the ditch at its outlet. In the example, the average elevation for a 24-hour period for a flood of 2-year frequency is 23.7.

In the example, it is assumed the drainage engineer has examined the watershed area and determined the drainage coefficients as outlined previously. $Q = 131 M^7$ is used to calculate runoff from the hill land and $Q = 45 M^{5/6}$ is used to calculate runoff from flatland.

The required depth of the ditch is determined at control points for the discharges at these points. This assumes that the runoff throughout the reach enters uniformly. The depth at the beginning and end of the reach will differ. The depths are established below the hydraulic gradeline and the bottom normally will not be parallel to the hydraulic gradeline. At points where concentrated flows enter a change in either depth, width or both may be required.

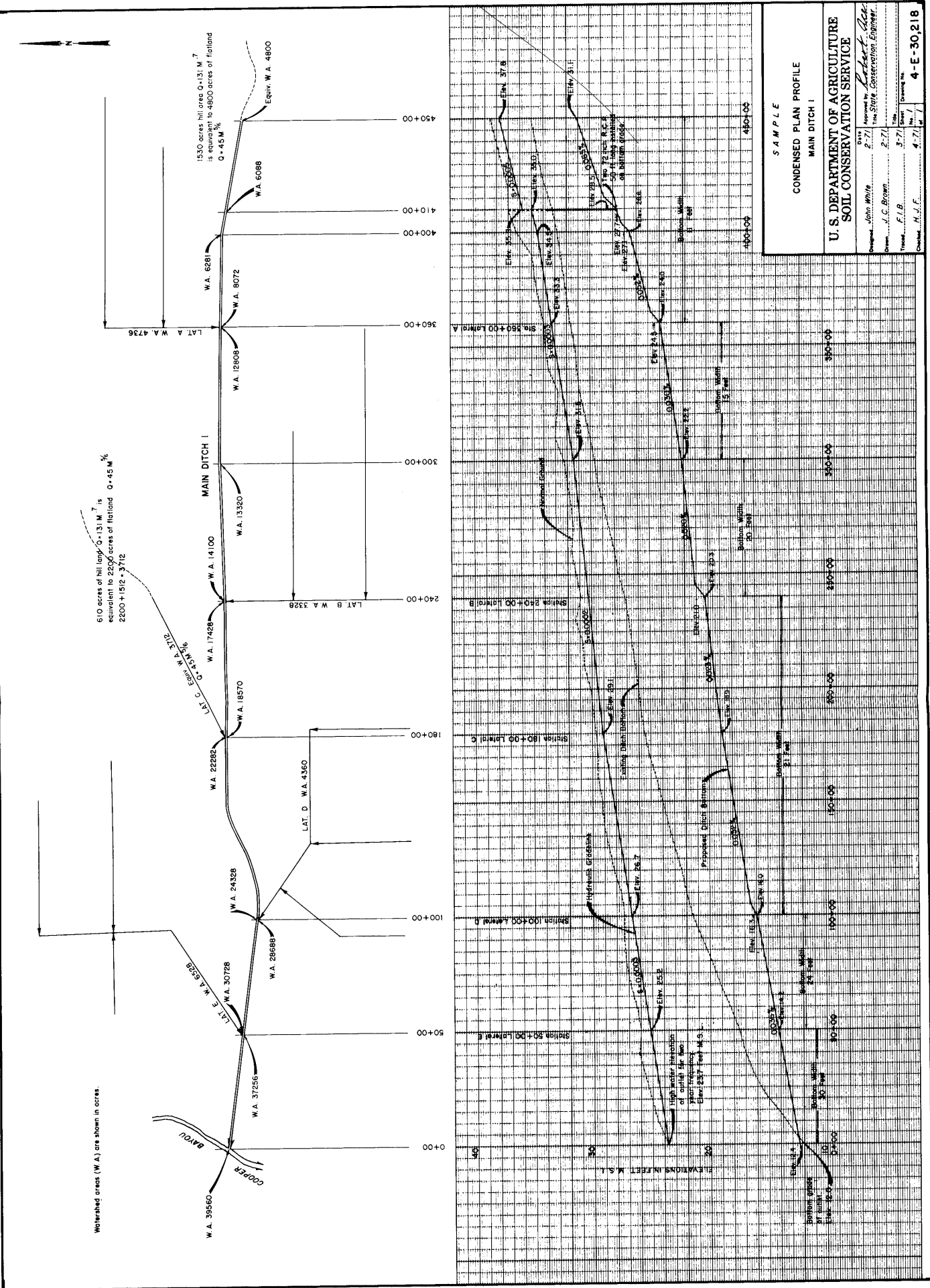

Figure 5-7, Sample--Condensed plan profile

Figure 5-7, Sample--Condensed plan profile

Design sheet table 5-4 illustrates several points. At station 450+00 there is a contributing watershed area of 1,530 acres of hill land to which the curve developed from $Q = 131 M^{.7}$ applies: Since the majority of the watershed is flatland the ditch will be designed on the curve developed from $Q = 45 M^{5/6}$. This calls for an initial conversion to an equivalent area as follows: Enter figure 5-5 with 1,530 acres, intersect the runoff curve developed from $Q = 131 M^{.7}$ and read a discharge of 240 c.f.s. Using this discharge draw a horizontal line and intersect the curve developed from $Q = 45 M^{5/6}$; from this point draw a vertical line to the watershed in acres and read the equivalent area of 4,800 acres.

Above the culvert at station 410+00 we have 5,888 acres drainage area. This gives 285 cubic feet per second runoff on the curve developed from $Q = 45 M^{5/6}$. This is a farm road crossing and some flooding at the culvert can be tolerated. The culvert is given a safety factor of 25 percent and this applied to the runoff at the culvert gives a Q of 354 c.f.s. To pass this amount of runoff through two 72-inch reinforced concrete culverts 50 feet long will require a head loss of 0.8 foot. In the example figure 5-7, this head loss is shown by dropping the hydraulic gradient 0.8 foot on the lower side of the culvert. The culvert is planned to be installed on this bottom grade.

In combining the flow of laterals the 20-40 rule should be used. One example is station 360+00 where the watershed of the main ditch above the station is 7,872 acres and the watershed lateral is 4,736 acres. The watershed area of lateral A is 37.5 percent of the total watershed area. The application of the 20-40 rule gives 596 c.f.s. for design flow below station 360+00.

The drainage area above lateral B at station 240+00 is 13,900 acres and the watershed of lateral B is 3,328 acres. The watershed of lateral B is 19.3 percent of the total watershed. Since the watershed of lateral B is less than 20 percent of the total watershed, the design flow below station 240+00 is based on the total watershed area of 17,228 acres. Laterals C, D, and E all have watersheds less than 20 percent of the total area and are all handled similar to lateral B.

Auxiliary Structures and Practices

The hydraulics and design of structures are discussed in NEH, Sections 5, Hydraulics, and 6, Structural Design. The following covers application and use of structures for open-drainage ditches. State handbooks should include typical plans and standards for design and installation of auxiliary structures and practices.

Pipe drops, chutes, drop spillways, and other suitable structures need to be installed where necessary to prevent serious erosion where surface water enters a ditch or where a shallow lateral joins a deep main. Grade control structures sometimes are required to stabilize the bottom grade of drainage ditches.

On drainage ditches in cultivated or pasture land the spoil usually should be spread and suitable vegetation established on the banks, berm and spread spoil. Where the ditch is in or adjacent to land which has been graded or leveled, or is surface irrigated, the spoil should be used for roads or worked into the grading plan for the field. Local technical guides should cover the best ways to establish suitable vegetation in drainage ditches, and on berms and spoil area.

Riprap, revetment, and other measures for controlling ditchbank erosion are frequently required. Ramps are used to protect the ditchbanks where ditches are open to pastures and livestock. Watergates are needed where fences cross ditches.

Junctions of lateral ditches

Where there is a significant drop from a lateral to a main ditch or other outlet, the lateral should be cut back on a level grade as specified and then graded back on a slope. This recessed area is to store sediment and protect the outlet ditch until the lateral stabilizes. Satisfactory results may usually be obtained by excavating the lateral on a grade level with the bottom grade of the outlet for a distance of 50 to 300 feet; then use a bottom grade out of the recessed area of from 0.5 to 1.0 percent until it intersects the normal bottom grade of the lateral. Where the drop from the lateral to the main is too great to control by the above method, structural protection must be provided.

In many areas, where irrigation waste water flows into open ditches, the accumulation of waste water from several fields may constitute a small but steady flow for as much as 90 days or more. This flow is comparable to perennial flow. Where soils are erodible it is essential to provide proper surface water inlets at points where waste water flows into deep drains.

State drainage guides should cover dimensions of level grades, maximum grade, and vegetative or structural protection necessary for various ditches, drainage areas, and soils.

Overfall pipes and structures

Pipe drops, drop spillways, chutes, and sod flumes are the usual measures used to drop surface water and flow from shallow field ditches into deeper open ditches. Unless effective measures are installed, rapid erosion of ditchbanks and rapid sedimentation of the ditch are likely to occur. In installing any overfall structure a minimum amount of excavation should be done at the structure. This reduces the backfill. There must be no seepage along or under a pipe or other overfall structure.

Sometimes it is more economical to construct a lateral ditch to collect surface runoff from several fields or lateral ditches and to drop the water into an open ditch at one point instead of installing several overfall pipes or structures at each of the field or lateral ditches. Such collecting ditches may parallel the spoil bank and should not interfere with cultivation.

To drop surface water from the land side of spoil banks into drainage ditches or from small laterals into deeper ditches, pipe drops may be used advantageously. Where an open ditch passes through an area of flatland having poorly defined drainage, surface water from the adjacent land may usually be handled by standard pipe-drop inlets. These inlets should be placed at the low points along the ditch. This may require a half-dozen or more structures per mile of ditch.

Pipe-overfall structures need to empty into areas recessed in the banks of the open ditch. This is particularly important if the ditch periodically carries heavy debris or ice. When installed in this manner, the pipes will not likely

be damaged by the movement of floodwater, debris, or ice in the outlet ditch and will not retard the flow in the ditch. (Photographs page 5-42.)

The outlet end of a pipe-overfall structure may extend a short distance over the embankment without support (cantilever installation). The cantilever section should be a minimum where subject to the flow of ice or debris in the ditch. Where debris and ice are not likely to damage corrugated metal, this type of pipe may be cantilevered without support as much as 10 feet. Where the cantilever length is greater than the allowable span for the ultimate load at the end of the pipe, the pipe should be supported. This may be done with two posts and a cross member or on a post and cradle set beneath the pipe. When not supported, it is well to extend the pipe into the bank a minimum distance of twice the overhang. To prevent excessive undercutting, the cantilever section generally should be not less than 4 feet.

Pipe-overfall structures may be installed with standard inlet sections or with reinforced concrete headwalls and wingwalls to give more stability. Antiseep collars along the pipe should be used where needed. Installing pipe-overfall structures on fills should be avoided wherever possible. All joints should be watertight.

The pipe should be well bedded. The bottom part of the excavation should conform to the shape of the pipe. Accurate shaping of the trench should extend up the sides of the pipe to a point where the backfill can be easily reached with a hand or mechanical tamper.

Careful tamping of the backfill by hand or a mechanical tamper should be specified. The soil used for backfill should contain sufficient moisture to insure high density when compacted. The backfill should be mounded over the pipe in such a way as to prevent surface wash along the pipe.

Hydraulic design of "island-type construction"

Pipe drops and overfall structures ordinarily should be of a capacity in excess of the design discharge of the drainage ditch. A capacity 25 percent greater than the design capacity of the drainage ditch is often used. Floodflows in excess of drainage flow may be bypassed over vegetated emergency spillways along the spoil bank. The spillway areas should be placed upstream and downstream from the drop at approximately 25 to 50 feet from the structure. Fill should be placed above the flood stage around the wingwalls of drop structures and pipe drops, and sodded to protect the structure. This installation is called the "island-type construction." Floodflows may need to be stored temporarily behind the spoil or dike when it is not possible to bring them safely back into the channel.

In some cases the island-type design is not applicable and the capacity of the structure may need to be large enough to pass the flow from a desired frequency storm.

Drop spillways

The design of drop spillways is covered in NEH, Section 11, Drop Spillways. Frequently drainage ditches fill with sediment, and the downstream toe of a spillway rests on a stable grade. Design requirements may be less exacting as a result of a stable or aggrading channel.

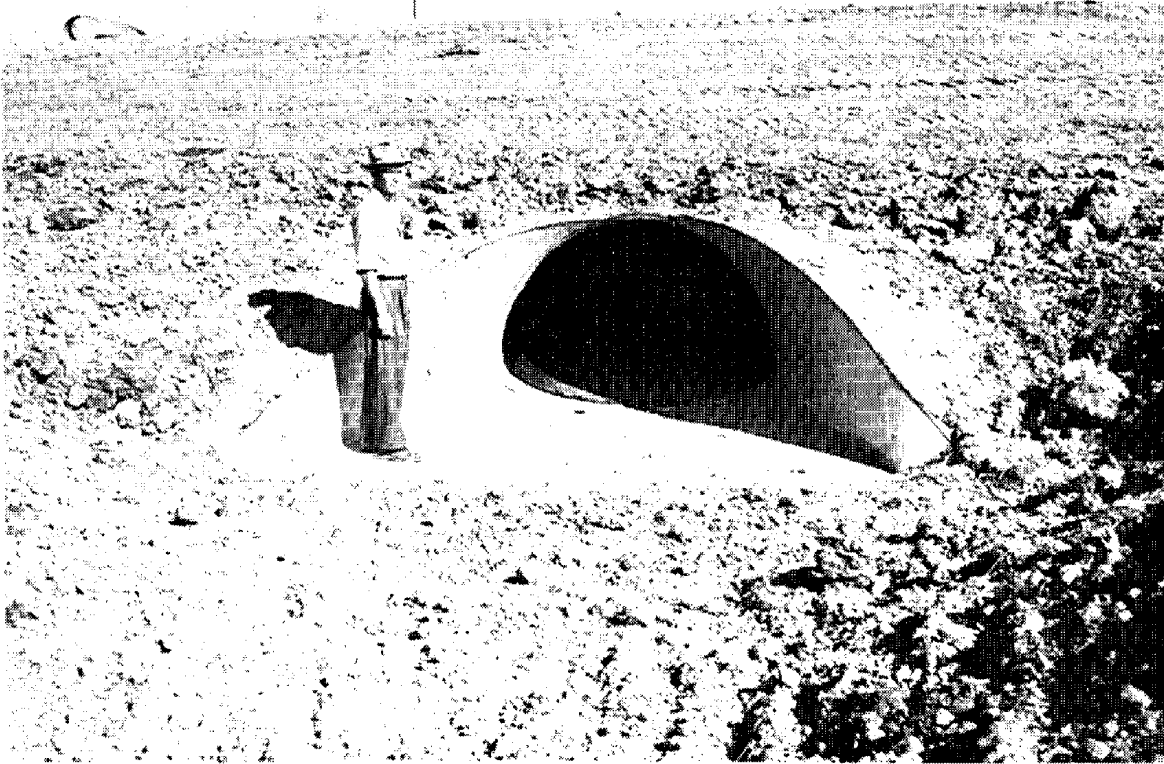

Prefabricated entrance section on pipe drop

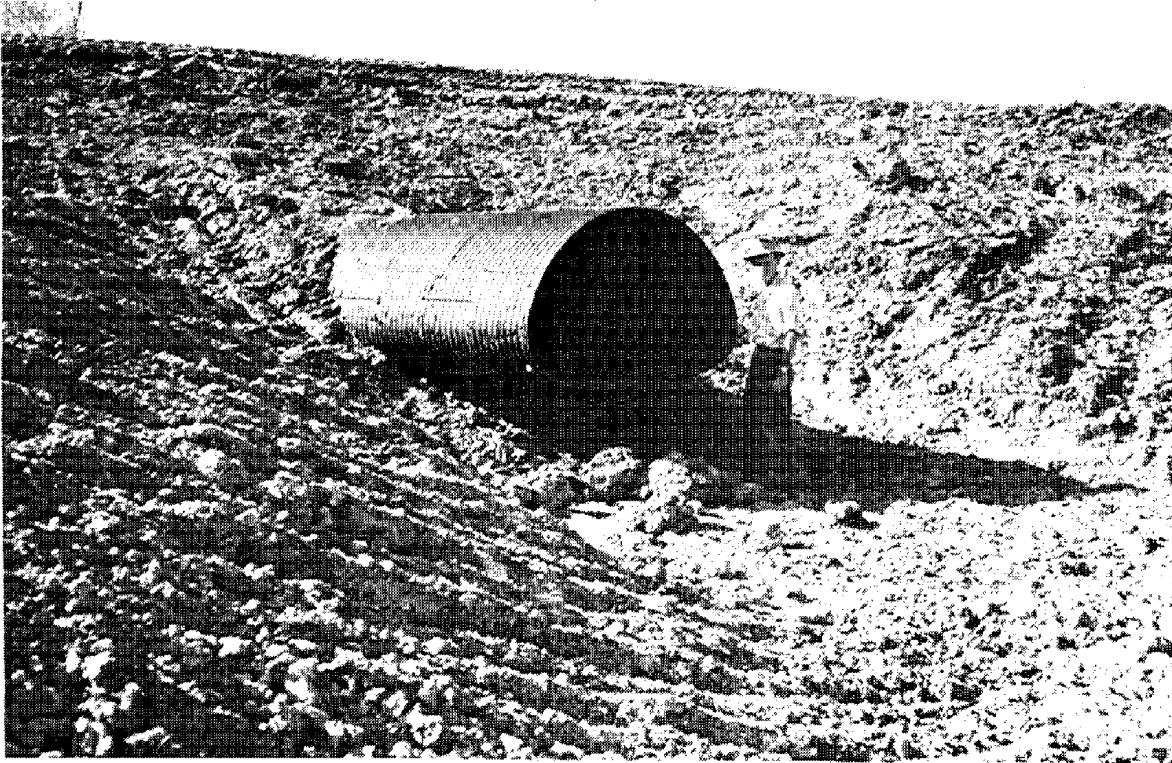

Recessed area at outlet of pipe drop

Concrete drop spillways usually are more costly for initial installation than pipe drops with vegetated spillways, and their use is limited in drainage work to exceptional conditions often involving a combination drop spillway and drain-outlet structure.

Chutes

Under some conditions reinforced concrete chutes may be more economical than drop spillways. Each chute requires a detailed plan. The design of chutes is covered in NEH, Section 14, Chutes.

Sod chutes

Under favorable conditions, sod chutes instead of a structure may be used to drop water into open ditches. Conditions favoring sod chutes include low drops, small drainage areas, ditchbanks having a fertile soil and subsoil, a climate and soil that support a dense grass and sod, and the absence of layers of soil that erode readily.

Grade-control structures

Where the velocity is excessive in open ditches, grade-control structures may be required. Occurrence of serious erosion after construction of drainage ditches cannot always be predicted. In large and important drainage work where serious erosion may occur, an on-site study is made of the factors affecting erosion and causing sedimentation. Similar drainage ditches should be studied to determine the probability of excessive erosion. Many drainage channels in loess and noncohesive or poorly graded soils have eroded and caused extensive damage.

Use of grade-control structures often may be avoided by adjusting the hydraulic gradeline or the bottom grade of the open ditch. On sections of the ditch having considerable slope, it may be possible to depress the hydraulic gradeline at the upper end of the reach and raise it at the lower end to obtain a nonerosive velocity. This usually involves added excavation, and any extra cost is balanced against cost of other means for grade control.

It should be remembered the velocity is influenced by three factors: (1) Grade of the ditch, (2) the value of "n", and (3) hydraulic radius. The designer has limited control over the grade of major channels except by adjusting the hydraulic gradeline. However, he may locate a longer meandering channel and reduce the average fall.

State and local guides should indicate the physiographic areas and soils subject to accelerated erosion that may require grade-control structures in open ditches. These guides should prescribe maximum velocity for specific soil types where there is information to substantiate velocities that exceed those allowable in T.R. 25.

Culverts and bridges

Wherever possible, bridges should be used in open ditches designed to capacity on low gradients in preference to culverts that offer serious resistance to the flow of water. However, culverts are economical near the upper ends of open ditches carrying a small flow. Culverts are generally used in many drains for western irrigated land where there is excess grade and small flow in deep

ditches. Culverts permit the installation of many economical farm-road crossings where more costly bridges could not be justified.

Culverts and bridges for state and county highways usually are constructed under the supervision and to the specifications of the state or county highway departments. Wherever appropriate, personnel of the Soil Conservation Service engaged in drainage design should explain the drainage requirements to state and county highway engineers responsible for such structures.

Failure to maintain ditches can cause culverts to fill rapidly with sediment. Where new road culverts are being installed, depth and capacity should be checked against drainage requirements. It is important to maintain the depth and capacity of these open ditches.

Culvert depth

The bottom grade of the upstream end of a culvert should be flush with the design bottom grade of the open ditch or possibly a few tenths lower. The upstream end of the culvert may be higher than the lower end or it may be level throughout its length.

If the bottom grade of the culvert is above the bottom grade of the ditch, it will back up water at low stages and cause rapid sedimentation in the ditch above the culvert. The bottom grade of the culvert should be based on future drainage requirements. A culvert set at the grade of a shallow ditch may be too high when the ditch is cleaned out or enlarged.

Watergates, cattle guards and ramps

Where applicable, plans for open ditches should include plans for watergates and ramps to be installed as aids in pasturing and to protect the ditches. (Photographs page 5-45.) Ramps should not be installed on the outside of curves or in low places where water will flow through them.

Construction Plans

General

Construction plans for drainage work usually form the basis for a contract. They must be clear, complete, and specific. They are often used by other agencies, private engineers, and individuals long after construction. They should be neat, reflect sound design, and be a credit to the Soil Conservation Service. All separate items of the plan should be identified with the name of the job(s), landowner(s), and location of farm(s). The scale used should be shown. The signature of the designer and the approving engineer and the date of signature should appear on all drainage plans.

Construction plans for individual farm ditches usually include:

1. Drainage plan map
2. Profiles
3. Cross sections
4. Ditch designs

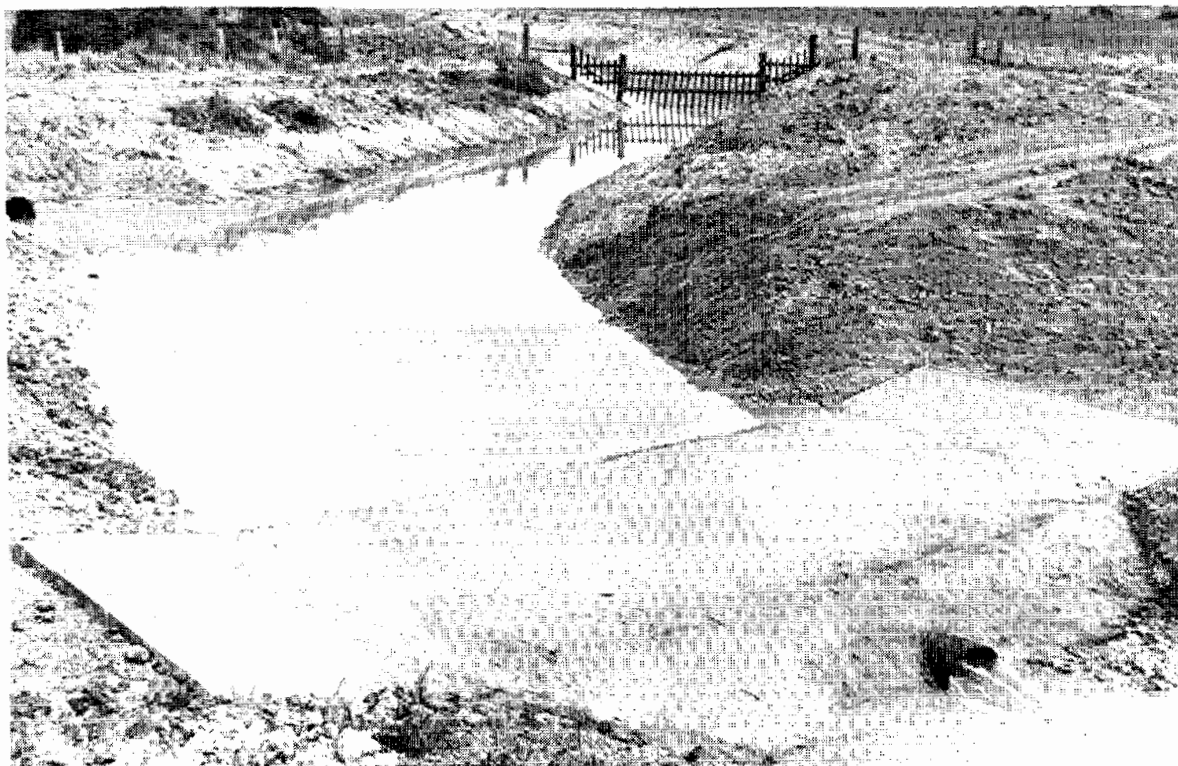

Low water crossing, watergate and pipe drop



Watergate showing hinged section

5. Structural details

6. Specifications

The plans should be discussed with the landowner or his representative to make sure he fully understands the proposed work. Cost estimates should be provided on request. Maintenance also should be discussed, and methods of maintenance and location of a travelway agreed upon.

The maintenance plan for group jobs should show an annual maintenance schedule and the practices to follow. It should cover details for carrying on maintenance operations and for periodic inspection. The method for payment of maintenance costs needs to be agreed upon and included in the group agreement when a group job is involved.

Drainage plan maps

Drainage construction plans for large jobs should include a map of the proposed improvement. The completed map should show the location of proposed ditches, bridges, culverts, farm boundaries, and names of owners where necessary, watershed boundaries and areas, existing land use, irrigation facilities, nearby towns, roads, railroads, township and section lines, and other features affecting the design, construction, and maintenance of the planned improvements.

On many jobs it is convenient to show the detailed plans on standard plan-profile sheets. Where this is done, the scale for the plan should be the same as horizontal scale used in plotting profiles. In such cases a general location map should be included to show the general layout of the system and to index plan-profile sheets. This map should show the entire watershed area within which the drainage-problem area is located.

Profiles

Plans for all ditches of the drainage system down to farm laterals should include profiles. The completed profiles should show the following:

1. Normal ground line and elevation of isolated low points in the field which the ditch will drain
2. Existing ditch bottom
3. Hydraulic gradeline
4. Proposed ditch bottom
5. Existing and proposed culverts, flumes, and other structures, and proper identification of each structure. Also note if an existing structure is to be removed
6. Points of entry of significant ditches
7. Elevation of high water for design storm at outlet
8. Width of ditch right-of-way to be cleared - notation by reaches
9. Datum used and description of important bench marks

10. Logs of soil borings
11. Elevations of water table and dates of reading if encountered in the soil borings.

Profiles should be plotted on standard-size, transparent, profile or plan-profile paper.

Cross sections

The number of cross sections required depends on the variations in cross section of existing ditches and on uniformity of topography along the proposed ditch location. The manner of payment also governs this.

Cross sections of proposed ditches are superimposed on original cross sections and the amount of excavation computed. At least one typical ditch cross section should be shown on construction plans.

Where the land surface is reasonably uniform the depth for new ditches may be obtained from the profile and excavation computed from yardage tables. Typical cross sections are plotted directly on the profile sheet when yardage is computed from tables or by computer from field notes. For others, cross sections should be plotted on standard-size transparent cross-section paper.

Soil borings

Sufficient soil profile information should be obtained through soil borings to locate any unstable soil conditions that may exist along the planned ditch route. It may be possible to reroute the ditch to bypass the unstable area.

Ditch-design calculations

The calculations made for the design of all ditches of the drainage system should be recorded on a standard ditch-design sheet and made a part of the plans. (Table 5-4.)

Structure details

Usually the structures for small to moderate-size drainage projects will be of standard size and design. For these, a copy of the detail design should be obtained and included in the plans. If a structure is to be designed by another agency, it may be so noted on the profile or plan map and the required elevation of the invert, or flow line, and the minimum capacity required should be specified.

If a structure is not standard and plans are prepared by the Soil Conservation Service, a set of plans and specifications should be included.

Plans for structures such as bridges, culverts, chutes, flumes, floodgates, drop structures, watergates, levees, dikes, and pumping plants, which are a required part of the drainage project, should be included. For bridges and culverts to be used for public roads, size, and the invert and road elevations are all that need to be shown.

Specifications

Written specifications are prepared for each item in a job proposal and standard specifications are desirable for the more common types of work.

On contract work along with the plans specifications become a part of the contract. On force account work they should be used by the person in charge of the job to insure that construction is in accord with the plan and required standards.

Specifications need to be detailed enough so there can be no reasonable misunderstanding as to the type of job desired. Nonessential details should be omitted.

Each work unit engaged in open ditch drainage work should have available standard specifications for the following items of construction.

1. Clearing
2. Clearing and grubbing
3. Channel excavation
4. Spoil bank spreading
5. Structure excavation
6. Concrete culvert pipe
7. Installation concrete pipe conduits and drains
8. Zinc-coated iron or steel corrugated pipe
9. Aluminum alloy corrugated pipe
10. Installation corrugated metal pipe conduit
11. Concrete
12. Steel reinforcement
13. Seeding ditchbanks

Maintenance of Open Ditches

Open ditches rapidly lose their effectiveness unless they are properly maintained. A good maintenance program is just as necessary as proper design and construction. Drainage systems often become clogged with uncontrolled growth of vegetation and partially fill with sediment soon after installation. Since maintenance is so important for successful drainage, every effort should be made to work out a maintenance program with the drainage enterprise, group, or landowner responsible for the system.

Responsibility for maintenance

The owners and elected officials of drainage projects must assume the responsibility for planning, financing, and execution of needed maintenance of the drainage improvements. Their investment in the improvements will be repaid by benefits from the project only if it is maintained over the years to function as planned. Training in maintenance requirements and methods should be provided to owners and sponsors of drainage projects.

Experience has shown that successful maintenance of group drainage projects requires:

1. An organization with authority to collect necessary funds.
2. Adequate funds on hand to start operations as soon as the project is accepted from the contractor.
3. A manager to direct maintenance operations.

The need for proper maintenance is especially important during the first two years after a ditch is constructed. It is desirable to establish adapted grass for erosion control on the ditchbanks as soon as possible. And during the first year or two the ditchbanks are especially susceptible to the growth of undesirable woody vegetation. Timely maintenance during this period will lessen the work needed later.

In cooperating with informal groups it is especially important to provide a written plan of maintenance, which covers maintenance requirements, methods of maintenance to be used and cost estimate. An adequate travelway supported by right-of-way easement should be provided.

In providing assistance to individual owners on open ditches a definite plan of maintenance is worked out and included in the conservation farm plan. Emphasis should be placed on practical and economical methods that maintain the effectiveness of open ditches.

Practices that reduce the need for maintenance should be given full consideration. A number of such points are included in the section on design. Others that have proved worthwhile include:

1. Developing farm conservation plans with landowners and operators to obtain best land use and erosion control practices on the area served by the system.
2. Installing erosion control measures in the watershed such as grade stabilization and critical area treatment.
3. Early establishment of erosion-controlling vegetation on ditch right of way.

Working out a maintenance plan

Maintenance work includes control of vegetation by mowing, pasturing, or chemicals, timely removal of sediment bars as they form, removing sediment after a few years accumulation, repairing structures, and doing such other work as necessary to retain the original effectiveness of the systems.

The following are some of the major considerations in working out a plan for maintenance:

Past history of maintenance

Knowledge of past maintenance efforts, or lack of them, should be available in the area. Maintenance methods which have been successful should be good guides in developing maintenance plans for similar work.

Economics of maintenance

A maintenance program must be effective or it cannot be justified economically. If ditches are allowed to be overgrown with brush and small trees they may have only one-half to two-thirds of the designed capacity. Land suffering from poor drainage produces poor crops and the cost/benefit ratio calculated to justify the drainage system will not be reached. Maintenance must be carried out effectively for the drainage system to operate as planned.



Channel with established vegetation and good maintenance

Methods of maintenance

Using construction equipment for maintenance. - Usually the same equipment used in construction can be employed economically for removal of sediment and re-shaping of spoil at intervals as needed after construction. The high cost of hand labor and difficulties in obtaining effective maintenance work by hand-tools emphasize the need for efficient equipment for maintenance work.

Mowing. - Mowing is effective in most locations in the humid areas for controlling brush and encouraging grass on ditchbanks, travelways and spoil disposal areas. Rotary mowers mounted on booms extending from tractors can handle 1½:1 side slopes with no particular hazard. Highway-type mowers on which the blade can be raised or dropped by 45 degrees are generally well adapted to ditch maintenance work. For maintenance by mowing with standard farm equipment 4:1 or flatter side slopes are preferable.

Pasturing. - Controlled pasturing is one of the most economical and effective methods of maintaining ditches. In some locations pasturing is not practical because of the type of farming adjoining the ditches. Pasturing should be controlled to keep cattle off ditchbanks during freezing and thawing and wet weather. Hogs should be kept out of ditches. A good pasture arrangement usually requires carefully placed gates and fences with watergates across ditches.

Burning undesirable vegetation. - In some locations controlled burning in the winter is useful to remove dead weeds, tall grass and small brush. This type of maintenance should be limited to channels through open areas and must comply with local antipollution regulations.

Chemical control of vegetation. - Chemicals to control undesirable vegetative growth have produced some excellent results. Caution should be used in their application to prevent damage from the drifting chemicals. Information on appropriate chemicals usually may be obtained from local dealers. Major chemical companies have prepared information relative to usage of specific products.

The most up-to-date information available, including data on new herbicides, should be followed.

Federal, State and local laws and regulations governing use of chemicals must be followed.

REFERENCES

- (1) STEPHENS, JOHN C., and MILLS, W. C.
1965. Using the Cypress Creek Formula to Estimate Run-off Rates in the Southern Coastal Plain and Adjacent Flatwoods Land Resource Areas. U. S. Dept. of Agriculture, ARS-41-95.
- (2) KING, HORACE WILLIAMS, and BRATER, ERNEST F.
1963. Handbook of Hydraulics, Fifth Edition. McGraw-Hill Book Company, Inc., New York.
- (3) BUREAU OF PUBLIC ROADS
1965. Hydraulic Charts for the Selection of Highway Culverts. Hydraulic Engineering Circular No. 5. U. S. Government Printing Office, Washington, D. C. 20402.
- (4) YARNELL, DAVID L.
1934. Pile Trestles as Channel Obstructions. U. S. Dept. of Agriculture, Tech. Bul. 429.
- (5) _____
1934. Bridge Piers as Channel Obstructions. U. S. Dept. of Agriculture, Tech. Bul. 442.

NATIONAL ENGINEERING HANDBOOK

SECTION 16

DRAINAGE OF AGRICULTURAL LAND

CHAPTER 6. DIKES

| <u>Contents</u> | <u>Page</u> |
|-----------------------------|-------------|
| General | 6- 1 |
| Classification of Dikes | 6- 1 |
| Investigations for Dikes | 6- 3 |
| Dike location | 6- 3 |
| High water determination | 6- 4 |
| Dike foundation | 6- 5 |
| Embankment materials | 6- 5 |
| Design of Dikes | 6- 5 |
| General | 6- 5 |
| Height of dike | 6- 8 |
| Top width | 6-10 |
| Side slopes | 6-10 |
| Core trench | 6-11 |
| Banquettes | 6-11 |
| Drains | 6-11 |
| Berms | 6-12 |
| Construction | 6-12 |
| Foundation preparation | 6-12 |
| Embankment construction | 6-13 |
| Conduits | 6-14 |
| Protection from wave action | 6-14 |
| Maintenance | 6-14 |
| References | 6-15 |

Figures

| | |
|--------------------------------------|------|
| Fig. 6-1 Typical dike section | 6- 8 |
| Fig. 6-2 Wave height curve | 6- 9 |
| Fig. 6-3 Dike section with banquette | 6-12 |

Tables

| | |
|--------------------------------|------|
| Table 6-1 Dike classification | 6- 2 |
| Table 6-2 Soil characteristics | 6- 6 |

NATIONAL ENGINEERING HANDBOOK

SECTION 16

DRAINAGE OF AGRICULTURAL LAND

CHAPTER 6. DIKES

General

Dikes are embankments constructed of earth or other suitable materials to protect land against overflow or flooding from streams, lakes, and tidal influences, and also to protect flat land from diffused surface waters. Dikes are generally used for the following purposes:

1. To protect bottom lands along one or both banks of a stream or channel from overflow caused by high stages or backwater from the outlet.
2. To provide additional out-of-bank capacity for floodways.
3. To provide floodways across bottom lands for conveyance of upland runoff to streams.
4. To protect the shores of lakes, desilting basins and impoundments against wave action and inundation during high water stages.
5. To protect coastal areas of oceans, bays, and estuaries against overflow from diurnal and wind storm tides.
6. To protect lands in areas of high rainfall and flat topography from diffused surface waters.

Dikes are intended to protect land against overflows of intermittent occurrence and short duration and not against continuous impoundment as in the case of dams. When restricting flood flows along streams, dikes tend to increase water surface elevation, velocities, and maximum discharges within the confined stream reaches and also increase the rate of flood wave travel downstream.

Dikes complicate drainage of the lands they protect. Facilities for runoff from protected areas must be provided at all stages of flow unless adequate storage is available. Ordinarily, discharge through dikes is obtained by gravity flow through conduits equipped with automatic flap or tide gates. Such gates prevent reverse flow into protected areas when stages on the water side of dikes are higher than on the land side. When prolonged flood stages prevent gravity outflow, the runoff from protected areas must be accumulated and stored temporarily in low areas behind the dikes; be removed continuously by pumps; or disposed of by a combination of these two methods. (See Chapter 7, "Drainage Pumping" and Chapter 9, "Drainage of Tidal Lands.")

Classification of Dikes

The requirements for construction of dikes are governed by site conditions and design criteria. The design requirements are determined by value of crops and property and the hazard to life within the area to be protected. Dikes are classified as shown in Table 6-1 in accordance with these factors.

Reference is made to Engineering Standard for Dike, Code 356, SCS National Engineering Handbook, Section 2.

Table 6-1, Dike Classification

| Class Conditions | Design & Construction Requirements |
|---|---|
| <p>I</p> <p>1-Possible loss of life should failure occur.</p> <p>2-High value land and improvements to be protected.</p> <p>3-Complex site conditions.</p> <p>4-The head of water against the dike in excess of 12 feet above normal ground, excluding sloughs, old channels and other low areas.</p> | <p>1-Design height equal to design water depth plus freeboard or wave height allowance of 2 feet or more.</p> <p>2-Design water depth measured or computed for the greater of the record flood or the 100 year frequency flood. When loss of life or high value property damage are not a primary consideration, the greater of the 50 year frequency flood or the desired level of protection.</p> <p>3-Cross section design according to site exposure to wave action and soil stability analysis.</p> <p>4-Stable mineral soil required in foundation and embankment.</p> <p>5-Construction according to site conditions and criteria for earth embankments. Refer to SCS National Engineering Handbook, Section 20.</p> |
| <p>II</p> <p>1-Agricultural lands of medium to high capability with primary improvements in farmsteads and other valuable facilities.</p> <p>2-The head of water against the dike less than 12 feet above normal ground excluding sloughs, old channels and other low areas.</p> | <p>1-Design water heights exceeding 4 feet to be based on a 25 year frequency or greater flood. When this degree of protection is not economically or physically feasible a flood frequency less than 25 years may be used if fuse plug sections or other suitable relief measures are included in the design.</p> <p>2-Stable mineral soils required in the embankment. Organic soils permissible only as surface covering not in excess of 1 foot.</p> <p>3-Cross section design based on design water height and the method of construction.</p> |

Table 6-1, continued

| Class Conditions | Design & Construction Requirements |
|--|---|
| II (continued) | 4-Construction with material compacted by equipment travel or dumped and shaped. |
| III 1-Agricultural lands of relatively low capability with improvements of low value. 2-The head of water against the dike not more than 6 feet for mineral soils or 4 feet for organic soils excluding sloughs, old channels and low areas. | 1-Design based on SCS State Standards considering the site conditions. 2-Construction with materials available and suitable for use. |

Investigations for Dikes

The intensity of investigations for dikes depends upon the class of dike required and a careful evaluation and consideration of the site conditions present. The following is a discussion of investigations needed for dike location, determination of high water levels, foundation materials and embankment materials.

Dike location

After the classification of the dike is determined, the initial step in investigation and design is establishment of a tentative location. This involves consideration of:

1. The land use and improvements, both existing and proposed, within the area to be protected. This data may be used in evaluating economic feasibility.
2. Anticipated flood stages.
3. The manner in which drainage of the protected area will be provided.
4. Rights-of-way involved.
5. Physical problems to be encountered, especially soil conditions relating to foundation and fill for the embankment and access for construction and maintenance.

The following should be considered in the final dike location:

1. Construction on soils that provide the most favorable foundation conditions and the best embankment materials. The location of Class III dikes will generally be parallel with units of the drainage system.

2. The shortest, most feasible and economical route consistent with protecting the largest usable area.
3. Avoidance of hazards, such as sloughs, sharp eroding bends in watercourses, and direct exposure to significant reaches of open water.
4. Utilization of natural protection against waves, such as permanent stands of trees, reeds or brush. Trees and brush should not be allowed to grow on the dike however.
5. Bordering public roads or property lines for purposes of access and easements.
6. Coordination with units of the drainage system of the protected areas.
7. Use of natural storage basins within the protected areas to reduce pumping requirements and gate sizes.
8. The effect, if any, on existing dikes and adjacent lands which will result from the dike construction.

High water determination

Investigations for all classes of dikes must include a determination of the height, frequency and duration of floodwater stages. This is a logical next step after classifying and locating the dike.

High water stages along coastal areas usually result from the combination of high diurnal tides, high winds and waves. Storms along the Atlantic and Gulf Coasts may result in high water stages along the shorelines of nearby inland freshwater lakes. Flood stage records and dates are generally available from the Corps of Engineers, Coast Guard, municipal and port authorities, the Coast and Geodetic Survey of the U. S. Department of Commerce which issues annual editions of "Tide Tables - East Coast" and "Tide Tables - West Coast," and from landowners. (See Chapter 9, "Drainage of Tidal Lands"). In the absence of available records, duration of flood tides resulting from hurricanes may be assumed as about 75 hours along the southern and eastern coasts of the United States.

Flood data on streams can be obtained from the U. S. Geological Survey, other federal agencies, and state agencies. Data in the form of high water marks are frequently available from local community records, newspapers, and from landowners. Where information on flood stages of streams is not available, computations based on the hydrologic conditions of the watershed and on selected rainfall conditions can be made to approximate the discharge from which estimates of the anticipated flood stage can be made. Procedures for determining runoff are given in the SCS National Engineering Handbook, Section 4, "Hydrology" and in Section 16, Chapter 5, "Open Ditches."

Whenever floodplain runoff is restricted by dikes, the stage for design discharge must be determined. If the floodplain on only one side of a stream is diked out, the effect on depth, duration and extent of flooding on the floodplain of the opposite side must be determined. Legal complications can arise from any change in duration or stage of overflow resulting from dike construction.

Dike foundation

Foundation investigations are usually made concurrent with or shortly following tentative location of the dike. Soil borings are necessary for all classes of dike. Where standard soils surveys of the area are available, these may be used as guides for locating borings. When soil surveys are not available, selected borings should be located along the route. In some instances, it may be desirable to open a pit for a closer examination of sub-strata. Borings or pits should reveal (a) the elevation of the water table; (b) thickness, classification and position of each strata; and (c) the existence of any unsuitable materials. These borings should extend to a depth equal to the difference between the bottom of any existing or proposed channel or borrow pit and the design water surface. The location of excessively permeable strata should be known to determine their influence on piping, pumping costs and their relationship to the location of interior drainage facilities. Occasionally, it may be necessary to make mechanical analysis and permeability tests of the various strata encountered to obtain more complete information, using methods established for earth dams.

Embankment materials

Dikes are usually constructed of fill material borrowed adjacent to and parallel with the dike. In such cases, investigations for foundation and borrow material can be combined. Where unstable soil conditions are found, it may be more economical to change the dike location rather than to employ special construction methods necessary for unstable soils. For Class I and some Class II dikes, special borrow pits outside the immediate area of construction may be required and the fill material transported to the construction site.

"Soil Characteristics," given in Table 6-2, help in appraising soil conditions, permeability, and stability when making the preliminary investigations. Frequently, simple field tests suffice for determining stability of fill materials. Such tests are outlined in Chapters 1 and 2, Section 8, Engineering Geology, SCS, National Engineering Handbook.

Design of Dikes

General

Dikes can fail by overtopping, undermining, sloughing, and seepage channels along drainage structures placed through them. The dike design should reduce the possibility of failure from these hazards as much as possible. Dikes are usually long and have substantial differences in soil conditions along their routes. Often locations cannot be changed to obtain better foundations and the soils adjacent to the dike must be used in construction. Adjustments in the design section and in construction methods must be made along the course of dikes in accordance with these soil conditions.

Ample freeboard reduces the possibility of overtopping of dikes. Undermining is minimized by locating dikes far enough away from channels to eliminate exposure to high velocities and scour. Proper side slopes and construction methods minimize sloughing. Protection against seepage along culvert and discharge pipes is improved by increasing the seep line with antiseep collars. A seep line increase of 15 percent is usually sufficient. When installing drainage pumps, discharge is handled by locating the discharge pipe over the top of dikes. If placed through the dikes, pipes should be placed above the water surface and the connections between them and the pumps made with flexible couplings.

Table 6-2, Soil characteristics

| Group Symbol | Soil Description | Suitability - Dikes | Permeability and Slopes |
|--------------|---|--|---|
| GW | Well graded gravel and gravel-sand mixtures. Little or no fines. | Very stable - suited for shell of dike. Good foundation bearing. | Rapid - will need core. |
| GP | Poorly graded gravels and gravel-sand mixtures. Little or no fines. | Stable - suitable for shell of dike. Good foundation bearing. | Rapid - may not need core for lower stages of short duration. |
| GM | Silty gravels and gravel-sand-clay mixtures. | Stable - generally adequate for all stages. Good foundation bearing. Good compaction with rubber tires. | Moderate - may not need core except for long flood duration. |
| GC | Clayey gravels and gravel-sand-clay mixtures. | Stable - adequate for all stages. Good foundation bearing. Good compaction with rubber tires. | Slow permeability |
| SW | Well graded sands and gravelly sands. Little or no fines. | Very stable - adequate for low stages. Good foundation bearing. Compaction good with crawler tractor. | Rapid - may need core for high stages of long duration. |
| SP | Poorly graded sands and gravelly sands. Little or no fines. | Stable - adequate for low stages. Generally fair foundation bearing. Use flat slopes and wide berms. Compaction good with crawler tractor. | Rapid - will need core for long duration. Use flat slopes. Protect against wave action. |
| SM | Silty sands and sand-silt mixtures. | Fairly stable - adequate for low stages. Only fair foundation bearing. Use wide berms. Good compaction with rubber tires. | Moderate - use flat slope on water side. Protect against wave action. |
| SC | Clayey sands and sand-clay mixtures | Stable - adequate for all stages. Generally good foundation bearing. Fair compaction with rubber tires. | Slow - |

Coarse-grained soils - (Less than 50% passing #200 sieve)

Table 6-2, Soil characteristics (continued)

| Group Symbol | Soil Description | Suitability - Dikes | Permeability and Slopes |
|--------------|--|--|---|
| ML | Inorganic silts and very fine sands, rock flour, silty or clayey fine sands and clayey silts of slight plasticity. | Poor stability - generally adequate for low stages. Fair foundation bearing. Dumped fill on Class III dikes only. Fair compaction with rubber tires. | Moderate - use flat slope on water side. Protect slopes against erosion forces. |
| CL | Inorganic clays of low to medium plasticity, gravelly clays, sandy clays, silty clays and lean clays. | Stable - adequate for all stages. Fair foundation bearing. Fair compaction with rubber tires. Use dumped fill on lower stages only. | Slow - |
| OL | Organic silts and organic clays having low plasticity. | Very poor stability - may be adequate for Class III dikes of low height. Can use dumped fill. | Moderate - use for very low stage only. Slopes at natural angle of repose when wet. |
| MH | Inorganic silts, micaceous or diatomaceous fine sandy or silty soils and elastic silts. | Low stability - generally adequate for all stages. Difficult to compact. Could use dumped fill for low stages. Poor foundation bearing. | Slow - use flat slopes and protect against erosion. |
| CH | Inorganic clays having high plasticity and fat clays. | Fairly stable - adequate for all stages. Poor compaction, dumped fill may be adequate. | Very slow permeability. Use flat slopes on water side. |
| OH | Organic clays having medium to high plasticity and organic silts. | Very low stability - Adequate only for low stages and can use dumped fill. Has poor foundation bearing and compaction. | Very slow - use for low stages only. Use flat slopes. |
| Pt | Peat and other highly organic soils. | Very low stability - use only for temporary dikes. Remove from foundation for mineral soil dikes. | Variable - may vary significantly between vertical and horizontal. |

Fine-grained soils - (More than 50% passing #200 sieve)

Note: This table based on the Unified Classification System and field experience. Rubber tires refer to rubber tired equipment.

The cross section and density of materials affect embankment stability. High density and uniformity of fill materials for Class I dikes are obtained by systematic control of moisture and compaction during placement. Uniformity and adequate compaction of materials for Class II and Class III dikes are obtained through a study of moisture conditions at time of placement and placement methods used. Plastic soils may require added height and considerable maintenance to bring the settled fill to required height after wetting of fill takes place. Nonplastic soils and soils of low plasticity may slump excessively and thus require flatter dike slopes and raising of fills in shallow lifts during construction. Flatter slopes and special protection of the surface may be required on the water side of dikes exposed to flood stages of long duration, heavy wave action, or rapid lowering of the flood stage.

Height of dike

As shown in Figure 6-1, the design height of the dike (H) should be the sum of design high water stage (H_w) and the added height (H_v) for wave action or the freeboard (H_f) which ever is greater. H_s is an allowance for settlement which depends upon the materials used in construction and the method of construction. Maximum H_w is determined by the class of dike to be provided and H_w is based on the water surface profile, or the high water stage. Freeboard H_f is an allowance that is added to the design flood stage without consideration of wave height. Freeboard for dikes should be a minimum of 2 feet, but where wave action is expected, it should be increased to the full allowance for wave height. Wave height allowance should be based on the velocity and duration of wind, distance of open water facing the dike--fetch--orientation of the dike with respect to the angle of waves generated by prevailing winds, the depth of water, and the length of the dike. A lack of specific data on wave height and rideup on dikes requires judgment and consideration of all factors involved in a particular situation.

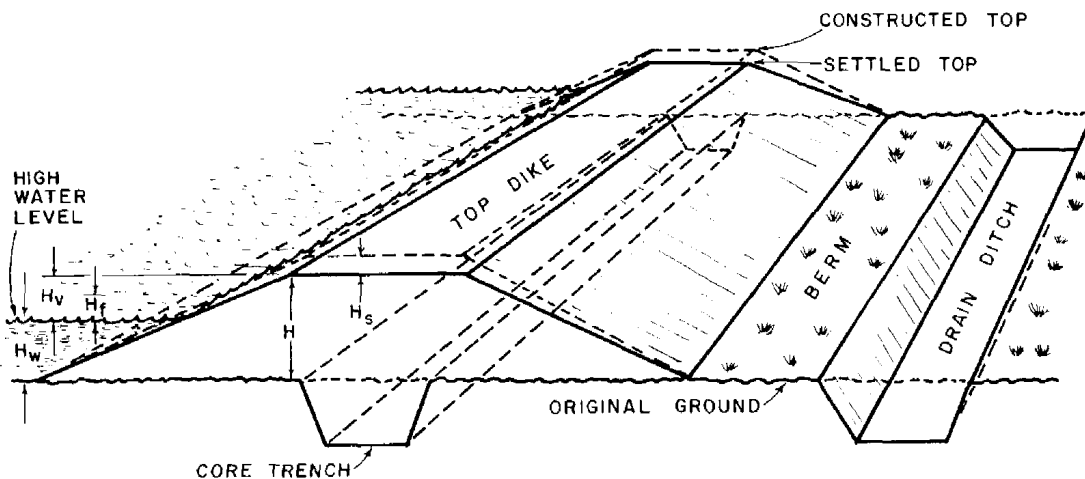

Figure 6-1, Typical dike section

Based on an American Society of Civil Engineers' report, which included a summary of empirical formulas for determination of wave height, the Bureau of Reclamation (1)* prepared a table of wave heights for selected lengths of fetch and wind velocities. Figure 6-2 is a set of curves based on the Bureau of Reclamation's analysis.

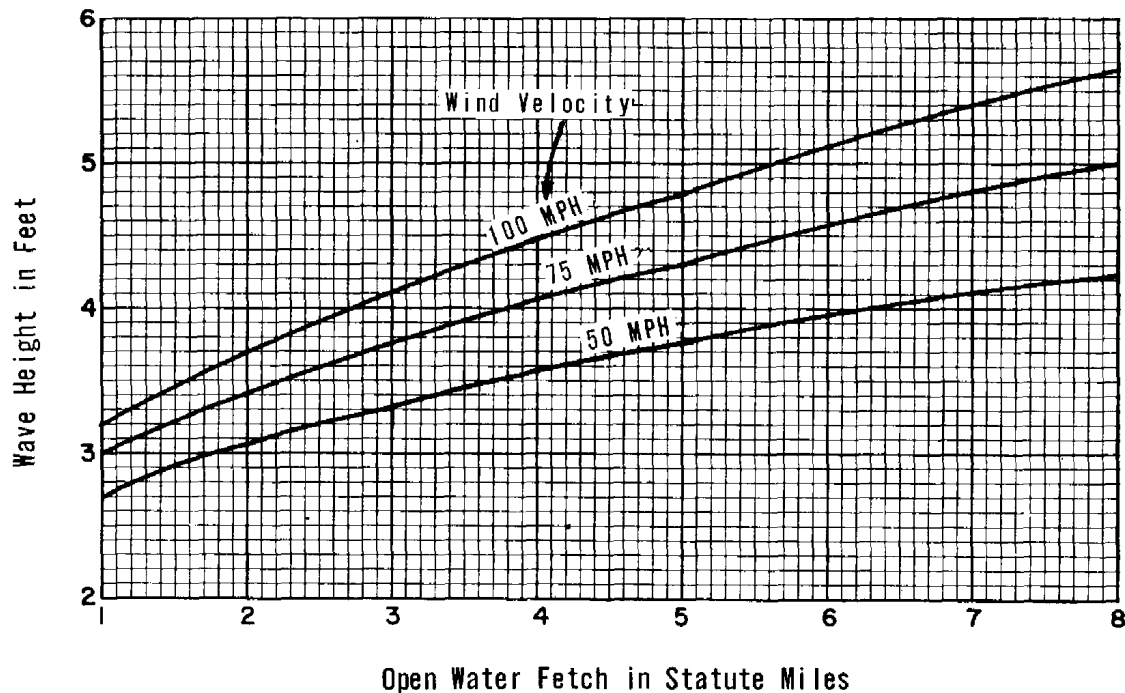

Figure 6-2, Wave height curves

The freeboard allowance for wave height should be sufficient to prevent overtopping of the dike due to wave rideup equal to 1.5 times the height of the wave as given by these curves, measured vertically from the still water level. Wind velocities for determination of allowance for wave height should range from 100 miles per hour for Class I dikes to 75 mph for Class II dikes and 50 mph for Class III dikes.

Vegetative growth between the dike and open water, if sufficiently high and dense, tends to reduce wave heights. In such instances adjustments in H_w should be made based on the type of plant growth, and the condition and permanence of the stand.

Settlement allowance H_s depends upon the soil material in the fill and foundation, and on the method of construction. The moisture content of the soil during construction is most important. Where the dike is to be compacted by construction equipment operating over the area, a settlement allowance (H_s) of not less than 5 percent of the fill height (H) should be included. Where a dumped fill is placed and shaped, the allowance should be not less than 10 percent of the height of the dike. For soils exceptionally high in organic matter, the settlement allowance should be no less than 40 percent since these soils are most likely to be placed in a near-saturated condition and are subject to shrinkage from compaction and oxidation of organic matter.

*Numbers in parentheses refer to references listed at the end of the chapter.

Top width

Top width of dikes should be varied according to soils type, degree of protection required and the depth of water controlled. Top width for Class I dikes of mineral soil should be no less than 10 feet for heights up to 15 feet and not less than 12 feet for heights above 15 feet. Top width for Class II and III dikes of mineral soil should be no less than 6 feet for designed water heights (H_w) up to 6 feet and 8 feet for heights over 6 feet. Top width for dikes of organic soil should be no less than 8 feet. Such dikes should be limited to designed water heights of 4 feet or less. Top widths should be at least 10 feet when the dike is to be used as a maintenance roadway. Additional width for "turn arounds" or passing areas should also be provided as needed.

Side slopes

Side slopes of dikes are dependent primarily upon the depth and duration of water impoundment and the shearing resistance of the earth fill and foundation materials. Side slopes should be 3:1 or flatter on both sides of dikes where soils of low plasticity, such as ML and SM soils, are used in construction. Side slopes should be 3:1 or flatter on the water side when appreciable wave action is expected, or where a steeper slope would be unstable under rapid drawdown conditions. Rapid drawdown can occur when hurricanes pass a given point and gale winds shift rapidly by 180 degrees to blow away from, rather than towards a given point. Rapid drawdown can occur also when flood crests drop rapidly. Land side slopes of dikes must be flattened when fill soils of relatively high permeability are exposed to high flood stages for extended periods of time. The seepage flow through these soils may then progress from water to land side at a relatively slight angle with the horizontal and outcrop on the land side of the dike to create a hazard. This action is most severe if the foundation for the dike is less pervious than the fill.

Side slopes for Class I dikes must be determined from stability analysis of the fill and foundation materials to be used. Where severe wave action is anticipated, unprotected slopes on the water side should not be steeper than 4 horizontal to one vertical.

Side slopes for Class II dikes, where water depths against the fill are less than 6 feet, should not be steeper than 1-1/2 horizontal to one vertical if fill is compacted by hauling equipment or by special compaction equipment after placement, and not steeper than 2 horizontal to one vertical when dumped in place. Where Class II dike fills impound water depths ranging from 6 to 12 feet, slopes should not be steeper than 2 horizontal to one vertical when compaction is obtained by hauling equipment or special compaction equipment after placement and not steeper than 2-1/2 horizontal to one vertical when the fill is dumped. If the water side of dumped fills are flattened to 3 horizontal to one vertical, the land side may in this case be steepened to 2 horizontal to one vertical.

Side slopes of Class III dikes should be based on the general considerations discussed above and experience with dike construction under similar conditions. Dikes constructed from channel spoil may be shaped to the required height and to the approximate cross section specified. The required side slopes may be contained within the dumped fill if it is excess to the minimum requirements.

Core trench

Where dike foundations contain pervious strata or the soils are sufficiently pervious to be subject to piping or undermining, a core trench or foundation cutoff should be provided. The core trench should have a bottom width and side slopes adequate to accommodate the type of equipment to be used for excavation, backfill, and compaction. Backfill should be made with materials equal to or better than those required for the earth embankment. Core trenches are used in both Class I and Class II dikes but are seldom required for Class III dikes. Where pervious foundations for Class I dikes are too deep to be penetrated by a core trench to an impervious cutoff, a drainage system must be provided to insure stability. Table 6-2, is a general guide to indicate conditions where a core trench is needed.

Where Class I dikes are located on pervious foundations, which are so deep that a core trench is not feasible, other means of controlling seepage and protection of the dike from subsurface piping must be used. Ways and means for controlling underseepage include properly designed and constructed land-side banquettes or seepage berms, relief wells and drains, waterside blankets of low permeability, cutoffs and drainage ditches.

The proceedings of a symposium on "Underseepage and Its Control" are included in the Transactions of the American Society of Civil Engineers, Volume 126, 1961, Part 1, pages 1427-1568. This includes a comprehensive treatment of investigations, control measures and construction and maintenance of control measures (2). The reference should be consulted for help with complex seepage problems.

Banquettes

Where dikes cross old channels or have excessively porous fills or poor foundation conditions, the land side toe should be protected by a banquette or constructed berm. Such banquettes may be used to provide construction access and added stability if channel crossings are under water or saturated during construction. The banquette width should be no less than the height of dike above normal ground elevation, and in case of Class I dikes it must meet design requirements determined from site investigations, laboratory analysis of fill materials and compaction methods. The finished top of the banquette should be no less than one foot above normal ground and should slope away from the dike to provide for runoff from the dike. Side slope of the extended section should be no steeper than the land side slope of the dike, see Figure 6-3. When highly permeable soil is used in the embankment over a more slowly permeable foundation, the land side base of dike may need to be extended and the entire dike cross section widened from base to top, in order to keep the line of seepage within the embankment. In this case the width of the banquette does not need to be increased.

Drains

Foundation and toe drains should be used where necessary to insure safety of dikes. These drains must be located on the land side of the dike and have a graded sand-gravel filter designed to prevent movement of the foundation or fill material into the drain.

Field drains must not be installed or permitted to remain, without filter protection, closer to the land-side toe of a dike than a distance equal to three times the design water height for the dike. If field drains are to be installed or remain closer than the distance stated above, they must be

protected with graded sand-gravel filters.

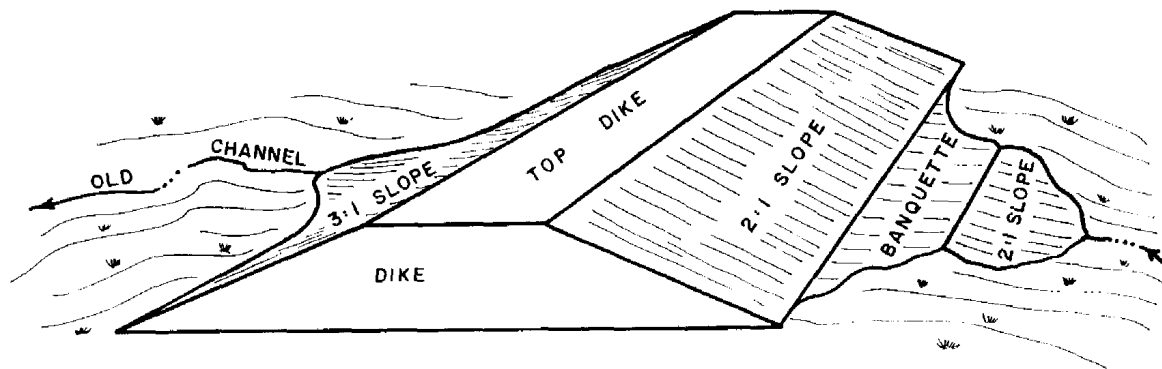

Figure 6-3, Dike section with banquette

Berms

Land-side ditches or borrow pits must be located so that the berm separating dike from borrow or channel is wide enough to protect the dike effectively. For Class I dikes, the berm and land-side ditches or borrow pits must be designed so the hazard of piping through the foundation is not increased. For Class II dikes the minimum width of berm should be 10 feet for heads of water against the dike not greater than 4 feet; and 15 feet for heads greater than 4 feet. For organic soils minimum berm width should be 25 feet. In all cases where the top width of the dike is less than 10 feet, the land-side berm should be at least 10 feet in order to be wide enough to accommodate a maintenance roadway.

Construction

Foundation preparation

The foundation area of dikes should be cleared of all trees, stumps, logs, roots, brush, boulders, or organic matter which would interfere with scarifying the area. All channel banks and sharp breaks should be sloped no steeper than one to one. Organic soil should be removed from the foundation area unless the dike is designed for and is to be constructed from organic soil.

Cutoff trenches, where used, must be excavated to lines and grades shown on the plans, and backfilled with suitable material as specified for earth embankments. Necessary compaction should be obtained by use of proper equipment adapted to the site conditions. The trench must be kept free of standing water during backfill operations. Material from the cutoff trench can be used in the land side of dike section when suitable. Where the dike crosses

old channels, objectionable foundation materials should be removed from the base section of the dike. No fill should be placed upon a frozen surface, nor should frozen earth, snow or ice be placed in the dike.

Embankment construction

For Class I dikes, the fill material must be free of all sod roots, frozen soil, stones over 6 inches in diameter, and other objectionable material. Placing and spreading of fill materials should start at the lowest point of the foundation and the fill brought up in horizontal layers or lifts of such thickness that the required compaction can be obtained with the equipment used. The resulting distribution and gradation of materials throughout the fill should have no lenses, pockets, streaks or layers of material substantially differing in gradation or texture from surrounding materials. Where materials of varying gradation and texture are necessary, the more impervious material should be placed in the water side and center portion of the fill. Moisture content of the fill materials must be such that the required compaction is obtained with the equipment used.

For Class II dikes, the fill material should be free from organic matter and any other objectionable material. The fill should begin on the lowest part of the base and continue in horizontal layers of approximately uniform thickness, preferably 6 inches thick, but no more than 18 inches thick depending upon the equipment used. The construction equipment should be operated over the area of each layer so as to break up the clods and obtain compaction. The impervious materials should be placed toward the water side of the dike. The fill materials should be moist but not too wet to hinder equipment operations. Water should be added where fill material is too dry for proper compaction.

When Class II dikes are constructed with equipment such as a dragline, which is not adapted to layer construction, the fill may be dumped in place and then spread and shaped by other equipment. Excessively wet materials should be placed so they will drain. If the material slumps excessively due to wetness, the dike should be constructed in stages to allow dewatering.

Class III dikes are usually constructed from spoil excavated from drainage ditches. The foundation should be prepared the same as for Class II dikes. Core trenches are seldom used in this class of dike. The spoil is placed to the required height for the dike and shaped. If the spoil is wet, it may be several months before it drains enough to permit shaping. Where additional stability or compaction is needed, the dike should be constructed in stages.

Except when constructed from material excavated from interior drainage ditches, the borrow for dikes is usually taken from the water side of the dike. Occasionally it is necessary to obtain fill from the land side of the dike, especially when it eliminates excavating through highly permeable strata on the water side which could result in excessive seepage through the dike during flood stages. A borrow ditch on the land side may be planned as a unit of the interior drainage system and the excavated material utilized in the dike. Such a ditch should be far enough away from the dike to eliminate undermining, and in accord with the guidelines given under "Berms." Physical features, such as roads, railroads and swamps and the lack of available usable material may require that the borrow be transported from a distant point.

When the borrow pit is located along the water side of the dike, it should be interrupted at intervals by plugs, as this checks velocity of water along the toe of the dike. They should be spaced at intervals not to exceed 400 feet

for Class I dikes and 1320 feet for Class II dikes. When the borrow is significantly stratified, the material for Class I and II dikes should be zoned for placement. In this way the more pervious material can be placed in the land side area and the less pervious soil put in the center or water side of the dike.

Conduits

All conduits through a dike must be placed on a firm foundation. Selected backfill material should be placed in layers around the conduits and each successive layer thoroughly compacted. Antiseep collars which will increase the seep line by as much as 15 percent, should be used on all conduits.

Protection from wave action

Dikes in an exposed position facing open water, may at times be subject to the destructive action of waves. Protective measures to safeguard the dike are necessary. The most widely used protective measures include: (a) heavy sod cover; (b) flat slopes on the water side; (c) extra top width; and (d) location of dike behind a wide foreshore, 100 feet or more in width where possible, on which adapted wave-obstructing vegetation can be established.

An adequate protective cover of grasses should be established on all exposed surfaces of the dike where this is necessary to protect the dike against erosion by flood flows, wave action, or from rainfall and runoff on the dike. The seedbed preparation, seeding, fertilizing, mulching, and fencing should comply with technical guides for the area.

Riprap protection of agricultural dikes is generally not feasible except for Class I dikes and short exposed sections of Class II dikes. Method (d), for protection from wave action, is the most desirable because it helps to dissipate the waves before they reach the dike. Bushy vegetation is best suited for counteracting wave action. This type of protective vegetation should be established beyond the borrow ditch and not on the berm.

Maintenance

The dike should be patrolled periodically and immediately after severe flood stages. Conduits through the dike should be thoroughly inspected as they are points of weakness. Any weakness must be repaired to prevent further damage and so the dike will continue to be effective. A good sod cover over the dike can prevent erosion rills and reduce the maintenance required for the dike. Trees and bushy growth should not be permitted to remain on the dike. Rodents' damage to dikes may be severe and they should be discouraged from burrowing in the dike. Mowing or controlled grazing by cattle is desirable when the slopes are 3:1 or flatter. The grazing must be controlled or the sod will be damaged. Hogs should not be allowed on the dikes. Control of trees and bushy growth with approved herbicides will assist in the maintenance of a sod cover.

Where sand substratum exists, a heavy seepage volume may be expected. Pumps installed at such locations to provide interior drainage should be regulated to keep the elevation of the water in the interior ditches as high as possible during flood stages. By keeping the difference in elevation of the outside water and that of the inside water to a minimum, the tendency for seepage water and sand to flow into the drainage ditches, and the possibility of bank sloughing, loss of capacity in the drainage system, and dike failure will be reduced.

References

- (1) UNITED STATES DEPARTMENT OF THE INTERIOR
BUREAU OF RECLAMATION
1960. Design of Small Dams, U. S. Government Printing Office,
Washington, D. C.
- (2) TURNBULL, W. J. and MANSUR, C. I.
1961. Underseepage and Its Control, Transactions of the
American Society of Civil Engineers, Vol. 126, Part I,
pp 1427 - 1568.

NATIONAL ENGINEERING HANDBOOK

SECTION 16

DRAINAGE OF AGRICULTURAL LAND

CHAPTER 7. DRAINAGE PUMPING

| | <u>Contents</u> | <u>Page</u> |
|--|-----------------|-------------|
| Scope | | 7-1 |
| Nomenclature and Definitions | | 7-2 |
| Need for Pumping | | 7-5 |
| Location of the Pumping Plant | | 7-5 |
| Incorporating the Pumping Plant in the Drainage System | | 7-6 |
| Static Lift | | 7-7 |
| Optimum stage | | 7-7 |
| Maximum static lift | | 7-8 |
| Minimum static lift | | 7-8 |
| Average lift | | 7-8 |
| Pumping Plant Capacity | | 7-9 |
| Determining factors | | 7-9 |
| Small surface areas | | 7-10 |
| Large surface areas | | 7-12 |
| Special areas | | 7-12 |
| Upper Mississippi Valley | | 7-12 |
| Florida | | 7-13 |
| Subsurface drainage | | 7-13 |
| Pumping Plant Design | | 7-13 |
| Selection of pumps | | 7-13 |
| Types of pumps | | 7-14 |
| Axial flow or propeller pumps | | 7-14 |
| Mixed flow pumps | | 7-17 |
| Radial flow pumps | | 7-17 |
| Number of pumps | | 7-17 |
| Pumping requirements | | 7-18 |
| Performance of pumps | | 7-18 |
| Total dynamic head | | 7-18 |
| Suction pipe head losses | | 7-21 |
| Net positive suction head (NPSH) | | 7-21 |
| Discharge pipe losses | | 7-22 |
| Specific speed | | 7-25 |
| Pump size | | 7-31 |
| Power and drives | | 7-33 |
| Electric motors | | 7-33 |
| Internal combustion engines | | 7-35 |
| Power drives | | 7-35 |

| | <u>Contents</u> | <u>Page</u> |
|--|-----------------|-------------|
| Power requirements | | 7-35 |
| Operating controls | | 7-36 |
| Safety controls | | 7-39 |
| Recorders and signaling devices | | 7-40 |
| Sump dimensions | | 7-40 |
| Sump capacity | | 7-44 |
| Stop logs | | 7-45 |
| Trash racks | | 7-45 |
| Discharge pipes | | 7-46 |
| Housing | | 7-47 |
| Field Tests of Drainage Pumping Plants | | 7-48 |
| Procedure for field tests | | 7-48 |
| Surveys and gages | | 7-48 |
| Total head on pump | | 7-48 |
| Discharge measurements | | 7-49 |
| Discharge measurements with Tulane pitot tubes | | 7-49 |
| Pump efficiency | | 7-51 |
| Operation and Maintenance | | 7-53 |
| References | | 7-54 |

Figures

| | | |
|--------------|--|------|
| Figure 7-1 | Pumping plant layout | 7-3 |
| Figure 7-2* | Propeller or axial flow pump | 7-15 |
| Figure 7-3* | Classes of centrifugal pumps | 7-16 |
| Figure 7-4 | Pump type selection chart | 7-19 |
| Figure 7-5 | Pump characteristic performance curves | 7-20 |
| Figure 7-6 | Head losses in riveted steel pipe | 7-24 |
| Figure 7-7 | Head losses for light flap gates | 7-26 |
| Figure 7-8* | Relationship of impeller design and specific speeds | 7-27 |
| Figure 7-9* | Limits of specific speed, single suction, radial and mixed flow pumps | 7-28 |
| Figure 7-10* | Limits of specific speed, double suction, radial flow pumps | 7-29 |
| Figure 7-11* | Limits of specific speed, single suction, mixed and axial flow pumps | 7-30 |
| Figure 7-12 | Motor selection chart | 7-34 |
| Figure 7-13 | Types of automatic control | 7-38 |
| Figure 7-14* | Sump dimensions versus flow | 7-41 |
| Figure 7-15* | Sump dimensions and pump arrangement | 7-42 |
| Figure 7-16* | Sump dimensions and pump arrangement | 7-43 |
| Figure 7-17 | Suction and discharge gages for pumping plant field tests | 7-50 |
| Figure 7-18 | Tulane pitot tube and template for measuring water velocity in pipes | 7-52 |

*See Note page 4

Tables

| | | |
|-----------|--|------|
| Table 7-1 | Properties of water at various altitudes | 7-23 |
| Table 7-2 | Properties of water at various temperatures | 7-23 |
| Table 7-3 | Pump classification according to speed and pressure magnitude | 7-31 |
| Table 7-4 | Pump size according to capacity and discharge velocity | 7-32 |

ContentsPage

APPENDIX A

| | |
|---|-------|
| Determining Pumping Plant Capacity Based on Hydrologic and Economic Factors | 7A-1 |
| Example | 7A-1 |
| Rainfall determination | 7A-1 |
| Runoff determination | 7A-1 |
| Runoff, pumping rate, storage relationships | 7A-5 |
| Stage-storage relationships | 7A-8 |
| Stage, damage area, benefit area relationships | 7A-8 |
| Pumping rate, storage, and damage area relationships | 7A-10 |
| Value of damages and benefits | 7A-10 |
| Operating costs | 7A-20 |
| Pumping rate at optimum cost-benefit ratio | 7A-20 |

Figures

| | | |
|--------------|--|-------|
| Figure 7A-1 | Pumping plant location | 7A-2 |
| Figure 7A-2 | Rainfall duration-frequency | 7A-4 |
| Figure 7A-3 | Mass runoff, frequency, duration, and pumping rate relationships | 7A-6 |
| Figure 7A-4 | Maximum required storage for various chances of occurrence and pumping rates | 7A-7 |
| Figure 7A-5 | Average annual storage at various pumping rates | 7A-9 |
| Figure 7A-6 | Relationships of stage, storage, and affected areas | 7A-11 |
| Figure 7A-7 | Acre-days impaired drainage at 1/2 inch pumping rate for various frequencies | 7A-14 |
| Figure 7A-8 | Impaired drainage damages with no pumping | 7A-16 |
| Figure 7A-9 | Value of damage by impaired drainage at 1/2 inch per day pumping rate | 7A-17 |
| Figure 7A-10 | Cost-benefit relationship at various pumping rates | 7A-19 |

Tables

| | | |
|-------------|---|-------|
| Table 7A-1 | Rainfall - runoff duration - frequency | 7A-3 |
| Table 7A-2 | Hydrograph base time length | 7A-5 |
| Table 7A-3 | Required maximum storage, inches | 7A-5 |
| Table 7A-4 | Average annual storage for various pumping rates | 7A-8 |
| Table 7A-5 | Stage, area, storage relationships | 7A-8 |
| Table 7A-6 | Relationships - stage to impaired drainage area | 7A-10 |
| Table 7A-7 | Relationships - stage, storage, pumping rate, and affected acres | 7A-10 |
| Table 7A-8 | Relationships - pumping rate to benefits | 7A-12 |
| Table 7A-9 | Relationships - impaired drainage and storage for various frequencies and pumping rates | 7A-13 |
| Table 7A-10 | Damages for various pumping rates and frequencies of occurrence | 7A-15 |
| Table 7A-11 | Average annual damages and benefits for various pumping rates | 7A-18 |
| Table 7A-12 | Cost-benefits at various pumping rates | 7A-20 |
| Table 7A-13 | Relationships - cost-benefit at various pumping rates | 7A-21 |

ContentsPage

APPENDIX B

| | |
|---------------------------------------|------|
| Design of Farm Drainage Pumping Plant | 7B-1 |
| Example | 7B-1 |
| Pump plant location | 7B-1 |
| Pump plant capacity | 7B-1 |
| Pump type and size | 7B-1 |
| Engine size | 7B-4 |
| Required power | 7B-7 |
| Sump dimensions | 7B-8 |

Figures

| | | |
|-------------|---|------|
| Figure 7B-1 | Pump drainage site layout | 7B-2 |
| Figure 7B-2 | Cross section of pumping plant layout | 7B-3 |
| Figure 7B-3 | Layout of principal dimensions - vertical axial flow pumps | 7B-5 |
| Figure 7B-4 | Table of principal dimensions - vertical axial flow pumps | 7B-6 |

Note: Figures 7-2, 7-3, 7-8, 7-9, 7-10, 7-11, 7-14, 7-15 and 7-16 reprinted from HYDRAULIC INSTITUTE STANDARDS, 12th Edition. Copyright 1969 by the Hydraulic Institute, 122 East 42nd Street, New York, New York 10017.

NATIONAL ENGINEERING HANDBOOK

SECTION 16

DRAINAGE OF AGRICULTURAL LAND

CHAPTER 7. DRAINAGE PUMPING

Scope

Pumps may be used for disposal of water from drainage systems when discharge by gravity flow cannot be obtained because of inadequate outlets or because of backwater from storm or tidal flooding.

The complexity and requirements for planning, designing, and constructing pumping facilities vary substantially from site to site. A dependable and economical pumping plant requires detailed investigation and survey of site conditions for planning and design. Planning requires consideration of the entire drainage system served so that diversions, storage areas, channels and outlets are used to best advantage in determining capacity, size, and operation of the pumps. Design requires consideration of a combination of pumping plant components in regard to the type, size, and capacity of the pumps; the kind of power to be used; the shape, size and depth of the sump; and between one component and another, as between pumps and sump.

The essential items in both planning and design of pumping plants will include a determination of:

1. The location of the pumping plant for an effective outlet to the entire drainage system, with consideration of an adequate foundation for the plant structure, access for the operation and servicing of the facility, and economy of installation.
2. The required water removal rate, with due consideration of crop requirements, protection of associated realty improvements (as buildings, access roads, etc.), and the effects of watershed characteristics (as topography, size, surface storage, and surface and subsoil conditions).
3. Auxiliary drainage facilities (as diversions, dikes, reservoirs, sumps, and gates) for protecting the facility and minimizing the pumping requirements.
4. The kind, capacity, size and number of pumps (but excluding their design which is a manufacturer's responsibility).
5. The type of power and prime mover adaptable to the site conditions, and the power requirements, availability, and cost.
6. The arrangement and size of forebay, sump, and discharge bay for the efficient movement of water through the pumping facility.
7. Auxiliary equipment including the operating controls.
8. Housing and protection of the pumps and prime movers.

Other items also important in planning are:

1. Arrangements for plant construction.
2. Installation and testing of equipment.
3. Plant operation, including the facilities and procedures for operation, maintenance, repair, and protection.

Nomenclature and Definitions

The following is a selected list of terms and parts of a drainage pumping plant and their definitions. (See figure 7-1.) Reference should also be made to Hydraulic Institute Standards - 12th Edition (1).

| | |
|-----------------------------|--|
| Drainage Pumping Plant | - A pumping facility, including one or more pumps, power units, and appurtenances for lifting collected drainage water to a gravity outlet. |
| Forebay | - Supply channel and open reservoir immediately adjoining the pumping plant for the collection and temporary storage of drainage water. |
| Trash Rack | - Bar grate between the forebay and sump for excluding large floating objects and debris that might plug, damage, or otherwise interfere with operation of the pumps. |
| Sump | - Pit, tank, or portion of reservoir within the pumping plant (the suction bay) from which collected water is withdrawn by the pumps. |
| Radial Flow Pump | - A centrifugal type pump in which the pressure for moving water is developed principally by action of centrifugal force. Water entering at the impeller hub flows radially to the impeller periphery. |
| Mixed Flow Pump | - A centrifugal type pump which develops pressure by both centrifugal force and the lifting action of the impeller on the water. |
| Axial Flow (Propeller) Pump | - A centrifugal type pump in which the pressure is developed primarily by the lifting action of the impeller (propeller blades) on the water. |
| Single-stage Pump | - Pump having a single impeller. |
| Multistage Pump | - Pump having more than one impeller mounted on a single shaft. |
| Pump Submergence | - Vertical distance between inlet of the pump and the water surface in the sump. |
| Bottom Clearance | - Vertical distance between inlet of pump and bottom of sump. |

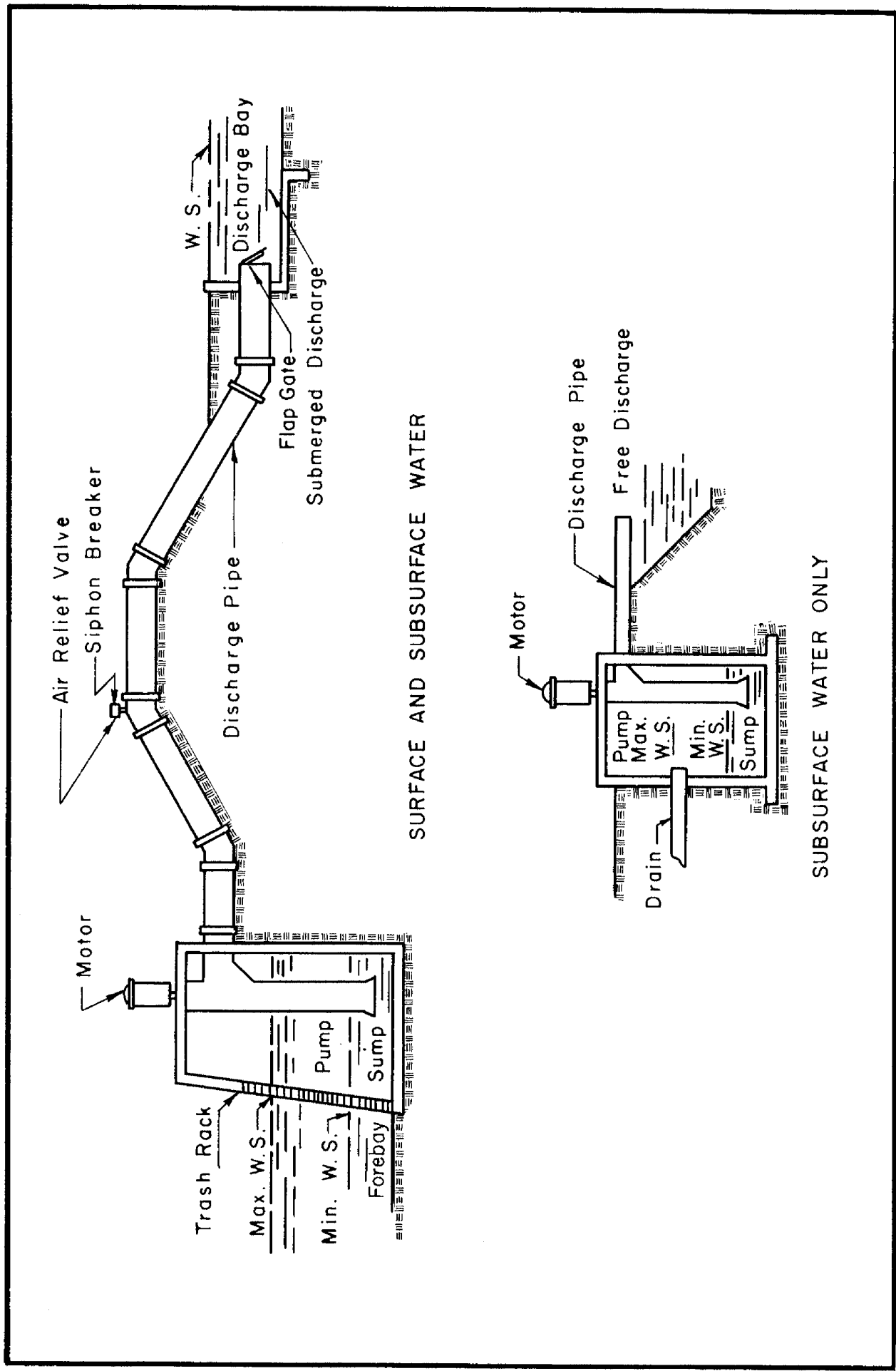

Figure 7-1, Pumping plant layout

| | |
|--------------------------|---|
| Side Clearance | - Horizontal distance between inlet of pump and nearest part of sump wall. |
| Suction Bowl | - Specially shaped section of pump which diverts water to the impeller. |
| Suction Bell (or Flange) | - Flared section at inlet end of pump either as a part of, or directly attached to, the suction bowl or attached to a suction pipe leading to the suction bowl. |
| Foot Valve | - Check valve installed at inlet end of suction pipe to retain water for pumps requiring priming. |
| Suction Umbrella | - A formed brim sometimes attached to the suction bowl to reduce disturbance at the inlet and reduce required submergence. |
| Suction Pipe | - Pipe leading from water supply to the suction bowl of the pump. |
| Discharge Pipe | - Pipe leading from discharge opening in pump to point of discharge. |
| Flap Gate | - Free swinging gate which prevents backflow of water into a submerged discharge pipe when the pump is not operating. |
| Discharge Bay | - Structure or pool into which pump discharge pipe empties. |
| Submerged Discharge | - Pump discharge through a submerged pipe. |
| Free Discharge | - Pump discharge through an unsubmerged pipe (pipe above water surface in drainage outlet). |
| Discharge Siphon | - Section of discharge pipe which may operate as siphon (at less than atmospheric pressure). |
| Air Relief Valve | - Device for releasing air from high point in discharge pipe to utilize siphon action. |
| Siphon Breaker | - Device to admit air at high point in discharge pipe for stopping siphon action. |
| Prime Mover | - Power unit to drive the pump, as an electric motor or an internal combustion engine. |
| Direct Drive | - Power transmission by direct connection between shafts of prime mover and pump without use of belts, gears, or chains. |
| Belt Drive | - Power transmission from prime mover to pump by belts and pulleys. |

| | |
|------------------------|--|
| Right-angle Gear Drive | Right angle beveled gears for transmission of power from horizontal drive shaft to a vertical pump shaft. |
| Automatic Control | System whereby starts and stops of pumping unit are regulated automatically as by a float switch, electrode switch, or bubbler unit. |
| Semiautomatic Control | System whereby pumping unit is started manually but stops automatically at a predetermined water level or set time interval. |
| Manual Control | System whereby pumping unit is started and stopped manually. |
| Float Control | Use of float to activate switch for starting and stopping pumping unit at predetermined water levels. |
| Electrode Control | Use of a pair of electrodes to activate switches for starting and stopping pumping unit at predetermined water levels. |

Need for Pumping

Sites that require pump drainage usually occupy flat lowlands adjoining oceans, bays, tidal estuaries, and lakes; bottom land of large rivers; and extensive glaciated areas where the outlets are inadequate or not available. Frequently, pumping is more practical than improvement of an existing watercourse to a gravity outlet because of difficulty in obtaining easements or funds to cover cost of construction or subsequent maintenance of an improved channel.

Usually, pumping is required only for short periods of time, such as during occurrence of a seasonal high water table, a seasonally high stage of river or lake, or at times of floodflow or backwater from storm runoff of irregular occurrence.

In some situations, need for pumping may develop gradually as in river bottoms where successive areas of land along reaches of channel are converted from hay or pasture to high valued crops and urban or industrial use and subsequently enclosed by dikes for protection from flooding. Pumping may become desirable or necessary as resulting reductions in river overflow areas cause increased frequency and duration of floodflows and corresponding increased periods of blockage and impeded drainage discharge.

Need for pumping inevitably develops in drained organic soils because of land subsidence. Pumping may be the most practical way of controlling the subsidence rate through regulation of the water table level. Pumping may also be used in irrigated areas to lower and control water table levels and provide for leaching of saline and alkali soils.

Location of the Pumping Plant

A wet area may be served by one or more pumping plants. Large areas with widely separated outlets may justify more than one plant. However, lower construction and maintenance costs, but not necessarily the best dependability,

usually are obtained when the drainage system is served by a single pumping plant.

Pumping plant locations are determined chiefly by topography and ground water conditions to which the drainage system layout must be tailored. Normally the site will be at the lowest elevation of the area served and at or as close as possible to the best outlet. However, other factors to be considered in arriving at the most advantageous site are:

1. Availability of forebay storage.
2. Required location of dikes.
3. Accessibility of powerlines and fuel supply roads and their adequacy for serving the plant. Cost of improvements to roads and connecting facilities for power supply and their maintenance.
4. Adequacy for structural foundations.
5. Ground water levels and their fluctuations.
6. Protection from vandalism.

Sites adjoining ditches or watercourses near an outlet often have unstable foundations. Better locations, requiring lower construction costs, may be found on higher, more stable ground. In such cases access channels can be constructed at the more desirable site to deliver the water to the pumps and from the pumps back to the stream.

Incorporating the Pumping Plant in the Drainage System

In order to minimize the amount of water to be pumped, the runoff from all areas that can be drained by gravity should be diverted from the area served by the pumps. Where direct diversion around the pumped area is not feasible, the surface runoff occurring at the low outlet stages should be discharged by gravity through gates in the protecting dike bordering the pumped area as long as the outlet stages will permit. In some cases it may be necessary to carry upland runoff directly to the outlet between dikes constructed through the pumped area.

The drainage system served by the pumping plant should be designed to meet drainage needs with as complete and uniform coverage of the area as practical. Mains and laterals should be established, as for gravity systems, through the natural depressions leading to the outlet. When practical, lower reaches of the main ditch should utilize available sloughs and ponds so as to increase forebay storage. Impoundment in such areas permit a reduction in the size of the pumping unit and may also provide more constant operating conditions because of less fluctuation in the water stage. Large storage capacity in such forebay areas and in the suction bay or sump of the pumping plant itself has other advantages such as reducing the need for night operation in the case of manually controlled pumps, or conversely, permitting an increase in night operation for electrically operated pumps when current can be obtained more cheaply at off-peak load rates, and in reducing seepage because of smaller head differentials.

The pattern of the drainage system served by the pumping plant should be planned so as to obtain a good hydraulic grade line and nonerosive velocities

between the sump and the most remote parts of the system during pump operation after drawdown is established. A split system of mains, leading to the pumping plant from different directions and having about equal lengths and collection areas, provides better water gradients to the sump than does a long single main. The mains should have ample depth and cross section area so that flow capacity can be maintained as uniform as possible between high and low water stages at the sump. The channel capacity must be adequate for pump requirements and flow must be within velocities sustaining channel stability when elevation of the hydraulic grade line at the sump is at low water (pump-stop level) stage.

Static Lift

Static lift is the height to which pumps must lift water under given conditions. It is the difference in elevation between water stages in the sump and the discharge bay or outlet when the discharge is submerged. When the discharge is not submerged, differences between water stages in the sump and the centerline of water in the discharge pipe at the high point of discharge determine the static lift.

Operating levels at the sump are determined by elevation of land to be drained or protected from overflow; by hydraulic grade and operating levels of water in the mains and laterals of the ditch system leading to the sump; and by the elevations of outlets to subsurface drains into the ditch system. Thus static lifts should be determined after the drainage system to be served by the pumping plant has been designed.

Data relating to forebay, sump and discharge bay should be studied in order to determine the maximum, minimum, and average static lifts for the pumps. These data are needed by pump manufacturers in order for them to select and supply equipment that will operate efficiently through the controlling ranges of lifts and also provide adequate capacity at maximum lift.

Optimum stage

Optimum stage is the sump elevation at which it is desired to hold the water level.

When pumping for subsurface drainage, optimum stage should be at the level that will give drainage to the lowest wet areas. Optimum stage may vary with the seasons of the year and with weather conditions. In humid regions this will be 4 or more feet below the land surface of most of the area served. In irrigated areas of semiarid and arid regions it will be in the range of 6 to 9 feet. In areas of organic soil, shallower depths to water table should be maintained in accord with recommendations in Chapter 8, Drainage of Organic Soils, and in local drainage guides.

When surface drainage is the primary consideration, optimum stage should be at the forebay elevation of the design hydraulic grade line of the drainage system served by the pumping plant. Although the actual hydraulic grade will fluctuate between start and stop elevations of the pump over the course of the pumping cycle, the design hydraulic grade line defines both the upstream areas to be protected and the amount of forebay storage available at design flow.

If the amount of storage for the planned protection is significant, pumps should be operated in such a manner as will keep storage available for whenever it may be needed. The stop level of the pump, or at least one of the

pumps in a multiple pump installation, should be at the lowest level of the planned storage basin for which a satisfactory pumping operation can be carried out. In setting such level, it should be kept in mind that pumping water too low may not only increase static lift but also result in suction of air into the pump and decreased pumping efficiency.

The pump-start level on automatically operated pumps should be set slightly lower than the design hydraulic grade line. In a manually controlled installation, the operator may need to anticipate weather conditions in determining pump start if an independent float-controlled or similar warning system is not used.

When both surface and subsurface drainage are to be handled by the same plant, a distinction between the two needs to be made. Generally, more than one pump would be required in draining large areas. In such case, a low volume pump would be used for subsurface flow and larger capacity pumps for surface flow, with optimum stage of each set accordingly. If a single pump is used to handle both surface and subsurface drainage, as is often the case in draining small areas, optimum stage for surface drainage would govern the pump selection and requirements for subsurface drainage would determine the pump-stop level.

Maximum static lift

Maximum static lift is the difference between the pump-stop stage in the sump and the maximum stage in the discharge bay or outlet when the discharge is submerged. If the discharge is not submerged, the high point in the centerline of the discharge pipe controls the maximum elevation of the lift. Maximum static lift should be determined with care to assure that adequate plant capacity is available during flood stages. Maximum stages in the discharge bay may be determined by establishing gaging stations or from records obtained from the Weather Bureau, Corps of Engineers, U.S. Geological Survey, municipalities, local newspaper files, and by inquiry of local residents.

Studies of operating conditions during flood periods have emphasized the importance of designing pumping plants for full capacity at maximum lift. Pumps discharging into large streams or rivers may need to operate for several days or longer at full capacity before maximum flood stages occur in the outlet and then continue operation until flood crests have passed.

Minimum static lift

Minimum static lift for pumps having a submerged discharge pipe can be estimated as the difference between the minimum stage of the discharge bay and the optimum stage of the sump. Where the minimum elevation of the discharge bay is above the controlling stage of a river or lake and also some distance removed, advantages of enlarging and deepening the connecting channel or removing obstructions should be considered.

Average lift

Pumping efficiency becomes an important factor in operating costs when plants are operated more or less continuously over an extended period of time (as much as 60 to 90 days for some facilities). In such cases, the average lift provides a better basis for establishing the most efficient pumping range. Where records of existing installations are available and the area and conditions are comparable, average lifts can be established from records of average

monthly lifts of operating plants weighted according to the amount of water pumped in respective months.

Pumping Plant Capacity

Determining factors

The required capacity of pumping plants may be determined from (a) drainage coefficients applied to the area served, (b) empirical formulas, (c) a study of existing installations, or (d) direct analysis using hydrologic procedures.

The capacity selected for the pumping plant should give consideration to such factors as size of the area served; the amount, rate and timing of rainfall and runoff; ground water conditions; and seepage rates.

For small areas of land ranging up to a square mile, complete and uniform benefits are usually necessary and obtainable. Thus the amount of water to be pumped should be about the same as would be required for a gravity drainage system with free outlet. Pumping plant capacity is usually determined on a daily rate basis so that for surface drainage systems the required capacity can be determined as the runoff from a 24-hour rainfall of a selected frequency of occurrence, plus base flow, less allowances for available surface and ground water storage. Rainfall periods exceeding 24 hours may need to be considered in evaluating available surface and ground water storage. Pumping plant capacity for removal of ground water only, as may apply in irrigated areas of the arid regions or areas of organic soils in humid regions, can be determined from the required capacity of subsurface drainage systems as covered in Chapter 4, Subsurface Drainage. However, experience in humid regions has shown the necessity of increasing this rate approximately 20 percent.

A number of interrelated factors need to be considered in arriving at an approximate pumping plant capacity for large land areas. These areas will contain small tracts where protection by pumping is neither necessary nor desired. An artificially depressed water table provides considerable temporary ground water storage. Also, numerous temporary surface pondages will occur which cannot readily drain to the pump. This permits reductions in pumping rates over runoff rates ordinarily provided for free gravity outlet.

Storage (as used in this text) includes runoff that moves freely into the voids of the soil profile above the normal or regulated ground water level plus the runoff in transit that temporarily fills up channels, sloughs, and other discernible pondages, including the innumerable minor depressions scattered over the ground surface. Any such storage which is not directly connected with the forebay of the pump will reduce pumping peaks but may prolong the flow to be handled by the pumps.

Pumping rates also may be influenced by correlations of occurrence, depth and duration of flood flows and ground water levels with crop management, growth, and tolerance to inundation. High water and overflow in winter and early spring usually present no problem in northern latitudes. Flooding of one or more days has less effect on hay and grass crops than on general field crops, whereas pondages of 4 to 6 hours may destroy truck crops.

Pumping plant size may be another consideration in determining pumping rates in that at some size an added increment of capacity will increase overall

construction, operation, and maintenance costs disproportionate to the increment in derived benefits.

While daily runoff provides the primary basis for determining pumping plant capacity, seasonal distribution of rainfall and runoff may have considerable effect in the final analysis and yearly runoff is often useful in estimating annual operating costs.

When design pumping rates for large areas have not been established locally, or comparable rates are not available for establishing local rates, estimates of runoff to be pumped can be developed through hydrologic procedures. Runoff so determined should be compared with drainage coefficients used for gravity discharge for their validity since storage in the ground and in the innumerable small surface depressions and the course and rates of water movement to and from such storage and depression areas on extensive flat lands are less clearly defined and accountable than on more sloping topography.

Base flow is derived from seepage into the pumped areas from uplands, irrigation, and adjoining bodies of water. In most situations the amount of seepage is difficult to evaluate. Significant amounts from uplands can be reduced at some sites by interception and diversion of surface and shallow subsurface flows and thus be eliminated from consideration. When upland waters occur as artesian flow within the protected area, amounts can be determined according to procedures indicated in Chapter 4, Subsurface Drainage. If significant, such flow should be included in the discharge to be handled by the pumps.

Large amounts of seepage may occur, even with installations of interceptors and diversion drains, if the pumped areas have extensive borders along irrigation canals, rivers, large creeks, or lakes. The amount of seepage depends upon differences in elevation of water surfaces within and without the pumped area, the extent and permeability of underlying water-bearing strata such as sand and gravel, and the length and location of drains in contact with such strata. Seepage is often a major source of water in pumped areas along large perennial streams where large and prolonged head differences may persist between regulated or flood flow stages of the channel and low laying lands within the pumped drainage area.

Normally head differences in pumped areas adjoining large lakes and some coastal shorelines are so small or of such short duration that seepage rates are not significant and need not be considered in the pumping rate determination. However, wind driven tides in some coastal streams, estuaries and shore areas frequently persist for several days. This may cause enough seepage into the area at a time when gravity outlets are blocked to require its consideration in design.

Small surface areas

Where local experience for establishing pumping rates is lacking, pumping plant capacity for drainage areas up to a square mile in extent may be determined from applicable drainage coefficients or may be computed by simplified hydrologic procedures. When such hydrologic procedures are used, a time interval should be selected for which protection from storm runoff can be justified economically. Usually a 2-year frequency of occurrence for a 1-day duration storm is ample for hay and pasture land, 3 to 5 years for rotated cropland (general field crops), and 10 to 20 years for special high value crops (truck crops). Precipitation for the 24-hour or longer duration storm

of the selected recurrence interval may be obtained from records of the nearest weather station or as determined from U.S. Weather Bureau Technical Papers 40 (4) and 49 (5). The required pumping capacity should then equal the optimum runoff obtained from such precipitation in a 24-hour period or

$$Q = P_1 - S_g - S_c - S_f + q \quad (\text{Eq. 7-1})$$

Where Q = inches of runoff to be removed in 24 hours

P_1 = inches of precipitation from the 24-hour storm
for the selected frequency of occurrence

S_g = inches of precipitation in temporary ground storage

S_c = inches of precipitation in temporary ditch storage

S_f = inches of precipitation in temporary forebay storage

q = inches of base flow (when seepage is significant)

Since ground and ditch storage may not be available in a succeeding 24-hour pumping period if storm duration extends over several days, a check of two or more day storms needs to be made in determining the required 24-hour pumping rate.

For example, a 200-acre tract near Syracuse, New York is used to produce truck crops. Soils are sandy silt loams. The site lacks an adequate outlet and is without surface storage areas. It contains a system of parallel drainage ditches spaced 200 feet apart and averaging 4 feet in depth. What capacity pump should be provided?

| | |
|--|-------------|
| 10-year 24-hour rainfall (from Weather Bureau TP 40) | 3.75 inches |
| Temporary ground storage (2-foot profile estimated at 1 inch per foot) | -2.00 |
| Ditch storage | -0.33 |
| Seepage | <u>0.00</u> |
| Runoff to be pumped in 24 hours | 1.42 inches |

Required pump capacity, Q_p , in gallons per minute, equals

$$Q_p = \frac{(\text{inches runoff}) (\text{acres drained})}{\text{hours pumped}} \times 448.8$$

where 448.8 gallons per minute equals 1 acre inch per hour

$$= \frac{1.42 \times 200}{24} \times 448.8 = 5330 \text{ or say } 5400 \text{ GPM}$$

As a check on runoff, Curve No. 75, Table 10.1, NEH Section 4 (2) is selected as applicable to the site. Then runoff for Curve No. 75 in Figure 10.1 (Standard Drawing ES-1001) NEH Section 4 (2) is determined to be 1.50 inches. This is approximately equal to the value of 1.42 inches previously determined.

As a check on effect of loss in storage of a second 24-hour period of pumping for a multiple-day storm, runoff distribution for Type I storm from NEH Section 4 is determined to be about 66 percent in first day and 34 percent in second day. Then:

| | <u>First Day</u> | <u>Second Day</u> |
|---|------------------|-------------------|
| 10-year 48-hour rainfall (from Weather Bureau TP 49) | 2.71 inches | 1.39 inches |
| Temporary ground storage | -2.00 | 0.00 |
| Ditch storage | -0.33 | 0.00 |
| Seepage | <u>0.00</u> | <u>0.00</u> |
| Runoff to be pumped in 24 hours | 0.38 inches | 1.39 inches |

Thus required runoff to be pumped in second 24-hour period of a multiple-day storm does not exceed that to be pumped in the one day storm of the same frequency of occurrence.

Large surface areas

Where there are no established local pumping rates for large areas, hydrologic procedures may be used to develop the runoff to be handled by the pumps. Because high costs are involved when installing, operating, and maintaining large pumping plants, and also because less uniformity in the realization of full benefits is attained from large pumped areas, more specific economic evaluations need to be considered in such pumping rate determinations. A method for establishing such rates, through use of both hydrologic and economic factors, has been developed by Adams (6). This method relates, first, the pumping rates and storage to hydrologic factors of the area served by the pump. Next, it determines relationships of pumping rate to benefited acres and annual costs. Finally, pumping rates, annual pumping costs, and average duration of flooding are related to a prescribed sump elevation. See illustrated example in appendix A.

In developing the relationships of pumping rate and storage to hydrologic factors of the area served by the pumps, priority should be given to use of local stage, duration, and frequency records of runoff. If these are not available, then runoff may be determined from rainfall data such as the Weather Bureau papers TP 40 (4) and TP 49 (5).

Special areas

Formulas have been developed for determining the pumping plant capacity in a number of specified areas. These formulas are based on investigations and studies of installed facilities. Examples are:

Upper Mississippi Valley (as reported by Sutton) (3)

Maximum plant capacity may be determined as

$$C = 0.33 (G + 0.023r)$$

where C = plant capacity in inches per 24 hours

G = drainage coefficient for similar gravity drainage systems in inches per 24 hours

r = annual runoff to be pumped in inches

The value of r ranges from 5 to 12 inches per year for pumped areas having considerable gravity drainage, 13 to 16 inches per year for areas with moderate seepage and all runoff pumped, to 16 to 35 inches per year for areas with heavy seepage. The formula was developed empirically from observed data of pumped areas ranging between 6,000 and 52,000 acres and including both seepage and gravity flow. More precise values can be obtained from data compiled for individual pumping plants.

Florida (South Florida and Everglades, as established by the Everglades Engineering Board of Review) (3)

$$Q = \frac{69.1}{M} + 9.6$$

where Q = runoff in cfs per square mile

M = drainage area in square miles

This anticipates overflow from occasional heavy storms. Experience with pumping in Florida has established the need for capacities per 24 hours of 3 inches for 1 square mile, 2 inches for 2 to 3 square miles, and 1 inch for 10 to 16 square miles for truck crops in organic soils. A capacity of 1 inch per 24 hours is considered adequate for sugarcane and pasture land.

Subsurface drainage

Small areas of 100 acres or less may have outlets adequate for disposal of surface water but inadequate in depth and capacity for lowering water table and disposal of ground water. When direct entry of surface water can be excluded from forebay and sump, pumping plant capacity can be determined as the design capacity of a subsurface gravity drainage system plus some allowance for flows that may occur in excess of the design rate. Experience has shown an allowance of 20 percent as ample. Thus

$$Q_p = 1.2 \times Q_g \quad (\text{Eq. 7-2})$$

where Q_p = pumped discharge capacity

Q_g = gravity discharge capacity

Design capacity of the drainage system should be based on drainage coefficients prescribed in Chapter 4, Subsurface Drainage, or by local drainage guides. Where prompt removal of surface water is not provided by surface drains, increased subsurface flow may take place and thus require consideration of a higher coefficient.

Pumping Plant Design

Selection of pumps

In selecting pumps, consideration must be given to the type, characteristics, capacity, head, and number. At the same time an accounting must be made of their relationship with the economy of the whole pumping unit, including the type and size of the power unit, sump, structure, and the plant operation.

Pumps suited to most agricultural drainage conditions must operate efficiently while moving comparatively large quantities of water at low heads and also may be required to handle substantial amounts of sediment and trash in the

effluent. For these reasons either axial flow (propeller), mixed flow, or radial flow pumps are commonly used. All are types of the centrifugal pump. A typical propeller pump is illustrated in figure 7-2. Information may also be obtained from Chapter 8, Section 15, NEH (7), USDA Technical Bulletin 1008 (3), various pump manufacturers catalogs, Engineering Society papers and standards, and textbooks.

Axial flow, mixed flow, or radial flow centrifugal pumps essentially consist of an impeller mounted on a power shaft within a casing. Liquid is energized by the impeller blade through pressure and increased velocity within the casing which serves as a guide for flow into and out of the impeller.

Types of pumps

Axial flow or propeller pumps

The axial flow or propeller pump may be vertical or horizontal, with fixed or adjustable blades and with one or more stages in the pumping lift. The impeller consists of comparatively flat open blades on a small hub, similar to a ship's propeller, but which is mounted on a shaft within a pipe or tubular housing. Flow is axial or parallel to the shaft and is developed by the lift or push of the water by the angular blades as they are rotated in the water column. (See figure 7-3.) The angular set of the blades on the shaft determines the head and speed. Propeller pumps are more sensitive than radial flow pumps and best efficiency is obtained within a relatively narrow range of head. Pumps must be operated in the range of good efficiency or noise and cavitation can occur with resulting high operating costs. Adjustable blades are provided by some manufacturers which permit greater flexibility in operation through variation in discharge at constant heads, variation in head under constant discharge, and variable combinations of both head and discharge. Adjustable blades are particularly advantageous on large pumps when the power supply for starting loads is limited, when internal combustion engines are used, and when water stages fluctuate rapidly, as may happen when sudden upland storm runoff occurs or where limited forebay storage is a factor.

Propeller pumps may be obtained for dynamic heads of 3 to 25 feet, speeds of 100 to 1850 RPM and capacities exceeding 100,000 gallons per minute. The vertical, fixed-blade single-stage pump is applicable to most drainage system requirements and is the most extensively used. (See figure 7-2.) In addition to satisfactory operation at heads of less than 10 feet and a wide range in capacity, propeller pumps require no priming, are simple in construction, and generally are low in cost. Propeller pumps require a minimum amount of floor space and housing, where housing is needed. Because of their high operating speed, propeller pumps can utilize less costly high speed motors and engines. A disadvantage of these pumps is that the discharge drops off rapidly at heads above design head and horsepower can increase significantly at and near shut-off head. Another disadvantage is that they are not readily accessible for cleaning and repair. Although small units can be hoisted readily above the waterline, large units usually require gates and other devices as stop-logs for closing the sump and auxiliary pumps for dewatering it. Large size vertical pumps also may necessitate unusually deep sumps to provide sufficient submergence for protection against suction and vortex action which cause mechanical vibration and blade deterioration. Use of horizontal or mixed flow pumps usually permit shallower, less costly excavations and sumps but are themselves more costly and require priming equipment.

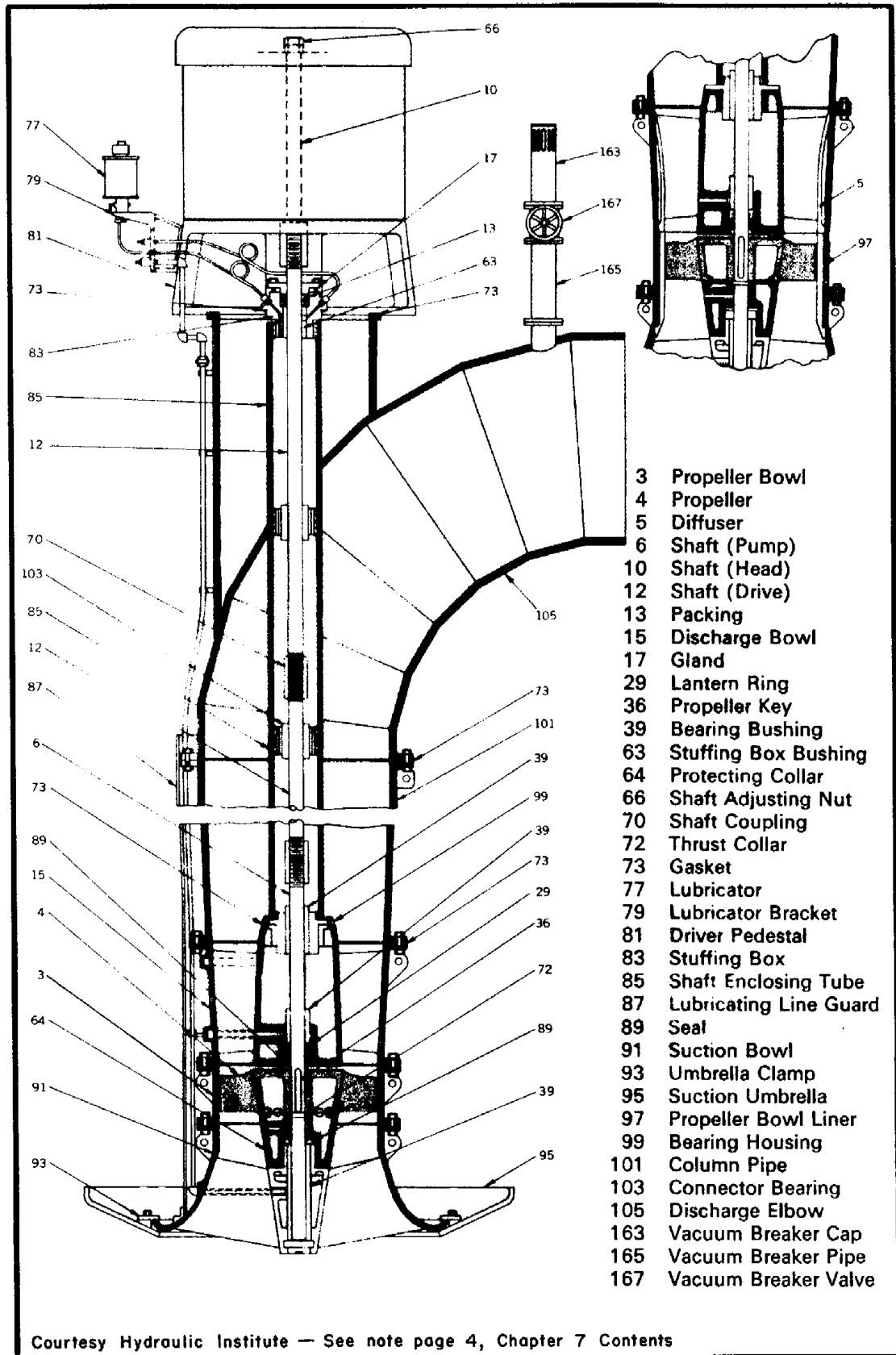
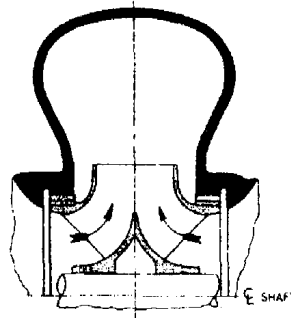

Figure 7-2, Propeller or axial flow pump

Radial Flow

A pump in which the pressure is developed principally by the action of centrifugal force. Pumps in this class with single inlet impellers usually have a *specific speed below 4200, and with double suction impellers, a specific speed of below 6000. In pumps of this class the liquid normally enters the impeller at the hub and flows radially to the periphery.



**Radial Flow Pump
(Double Suction)**

Mixed Flow

A pump in which the head is developed partly by centrifugal force and partly by the lift of the vanes on the liquid. This type of pump has a single inlet impeller with the flow entering axially and discharging in an axial and radial direction. Pumps of this type usually have a *specific speed from 4200 to 9000.

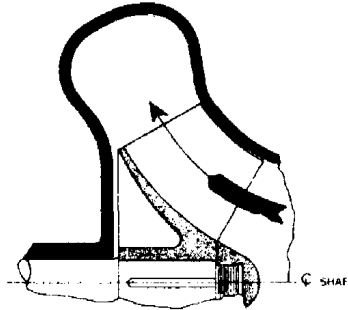

Mixed Flow Pump

Axial Flow

A pump of this type, sometimes called a propeller pump, develops most of its head by the propelling or lifting action of the vanes on the liquid. It has a single inlet impeller with the flow entering axially and discharging nearly axially. Pumps of this type usually have a *specific speed above 9000.

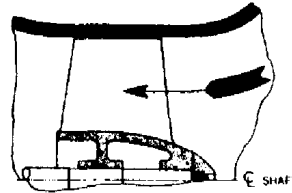

Axial Flow Pump

Mixed flow pumps

Mixed flow pumps utilize both lift and centrifugal force to develop flow which is partially radial and partially axial. See figure 7-3. Some types of mixed flow pumps are quite similar to the propeller pump and the developed flow is largely axial. An open vaned propeller is used in which the blades are fixed radially around a conical hub and housed in a slightly enlarged bulbous section of the casing. These pumps will operate more efficiently over a wider range of head and at higher heads, 10 to 90 feet, than the straight propeller type. Mixed flow pumps are also constructed with volute type casings (spiral shaped with gradually enlarging cross section toward the discharge flange) and curved impeller blades in which flow at low heads is predominantly centrifugal. Mixed flow pumps have an advantage in starting over the axial flow pump when the power supply is limited. These pumps will also handle silt and the passage of small trash.

Radial flow pumps

Radial flow pumps operate efficiently at moderate to high heads (20 to 200+ feet) and in handling large amounts of sediment. See figure 7-3. Liquids enter the impeller by suction and with increasing velocity, move radially from the hub to the end of the blade and thence into the casing by centrifugal force. The thrust against the casing walls converts the developed energy into pressure head. Radial flow pumps are either volute or turbine. The volute pumps have the spirally expanded casing as previously explained. The turbine type contains fixed expanding vanes into which the liquid is first thrust on leaving the impeller for conversion of velocity to pressure head before moving into the discharge or last stage in the casing. Hazards of clogging make the turbine type undesirable for surface drainage but satisfactory in deep well drainage. Impellers of centrifugal pumps may be open, semiclosed, or closed. In the open type, the blades are exposed on all sides except where attached to the rotor. In the semiclosed type, blades are mounted on a shroud (disc wheel) attached to the rotor, leaving blades open on one side. Open and semiclosed impellers will pass sediment and small trash without clogging. In the closed type, blades are between twin shrouds leaving only the ends of blades open. This type may clog and wear excessively from sand and other fine materials in drainage water. However, the Francis impeller, a closed type used in mixed flow and some types of radial flow pumps, is well suited to drainage. In the Francis impeller the vanes are so shaped that as the blades cut into the column of entering water, the water is first moved axially before converting to radial movement.

Both single and double suction impellers may be cased in radial flow pumps. The double suction impeller is better suited for drainage because larger capacities can be handled for the same head, and end thrust on the pumps is opposed, thus dynamically balancing up the unit.

Figure 7-4 is a guide to selection of the type pump based on pumping head and quantity of water to be pumped.

Number of pumps

The size and number of pumps are determined from the required plant capacity. Many farm pumping plants will handle the total requirement with one pump. For large watersheds and where high value crops or farmstead improvements require flood protection, it is advantageous to have two or more pumps to provide efficient pumping over a wider range of pumping rates and so that a breakdown of one pump will not stop all pumping. Experience has shown that in a plant with two pumping units, the most desirable range in pumping rates

is obtained when one pump has about half the capacity of the other. When three or more pumps are used, equal capacity of all pumps usually is most satisfactory. When both subsurface and surface flow are to be pumped, one pump should be selected for efficient operation at the head and discharge required for pumping subsurface flow. In any case, it is desirable that the size of one pump is such that it can operate continuously over comparatively long periods without frequent starts and stops. Where pumps must operate over long periods of time, they should be selected for maximum operating efficiency. Optimum efficiency of pumps is not essential for the short periods of operation that usually occur at peak stage or discharge.

Pumping requirements

Performance of pumps

Performance of pumps varies with head, speed, discharge, and horsepower. The relationship and effect of these on efficiency of the pumping operation are established by actual tests or from tests of geometrically similar prototypes. These data are compiled as characteristic performance curves of the pump as illustrated in figure 7-5. The curves provide a basis for selecting the pump that will provide the most efficient performance for the required operating conditions. Usually such data are supplied by the manufacturer. Because of the difficulty of testing with large volumes of water, performance of most large pumps is forecast from tests on small models.

Total dynamic head

Total dynamic head on the pump is the static lift plus all the losses in the pump, suction pipe and discharge pipe. Total dynamic head can be expressed as:

$$H_t = \left(h_d + \frac{v_d^2}{2g} + d_1 \right) - \left(h_s + \frac{v_s^2}{2g} + d_2 \right) \quad (\text{Eq. 7-3})$$

in which

H_t is the net total dynamic head in feet of water.

h_d is the discharge pressure head in feet of water, measured near the discharge flange of the pump (gage pressure). It is positive if the pipe is under pressure and negative if under vacuum at the point of measurement.

v_d is the average velocity in feet per second in the pipe where h_d is measured.

d_1 is the elevation of the gage measuring h_d in feet above some reference plane. It is positive or negative, depending upon whether the gage is above or below the reference plane.

h_s is the suction head, measured near the suction flange of the pumps (gage pressure). It is nearly always negative, since the suction pipe is usually under vacuum.

v_s is the average velocity in the pipe at the point where h_s is measured.

d_2 is the elevation of the gage measuring h_s above the same reference plane used to determine the elevation of the gage measuring h_d .

PUMP TYPE SELECTION CHART

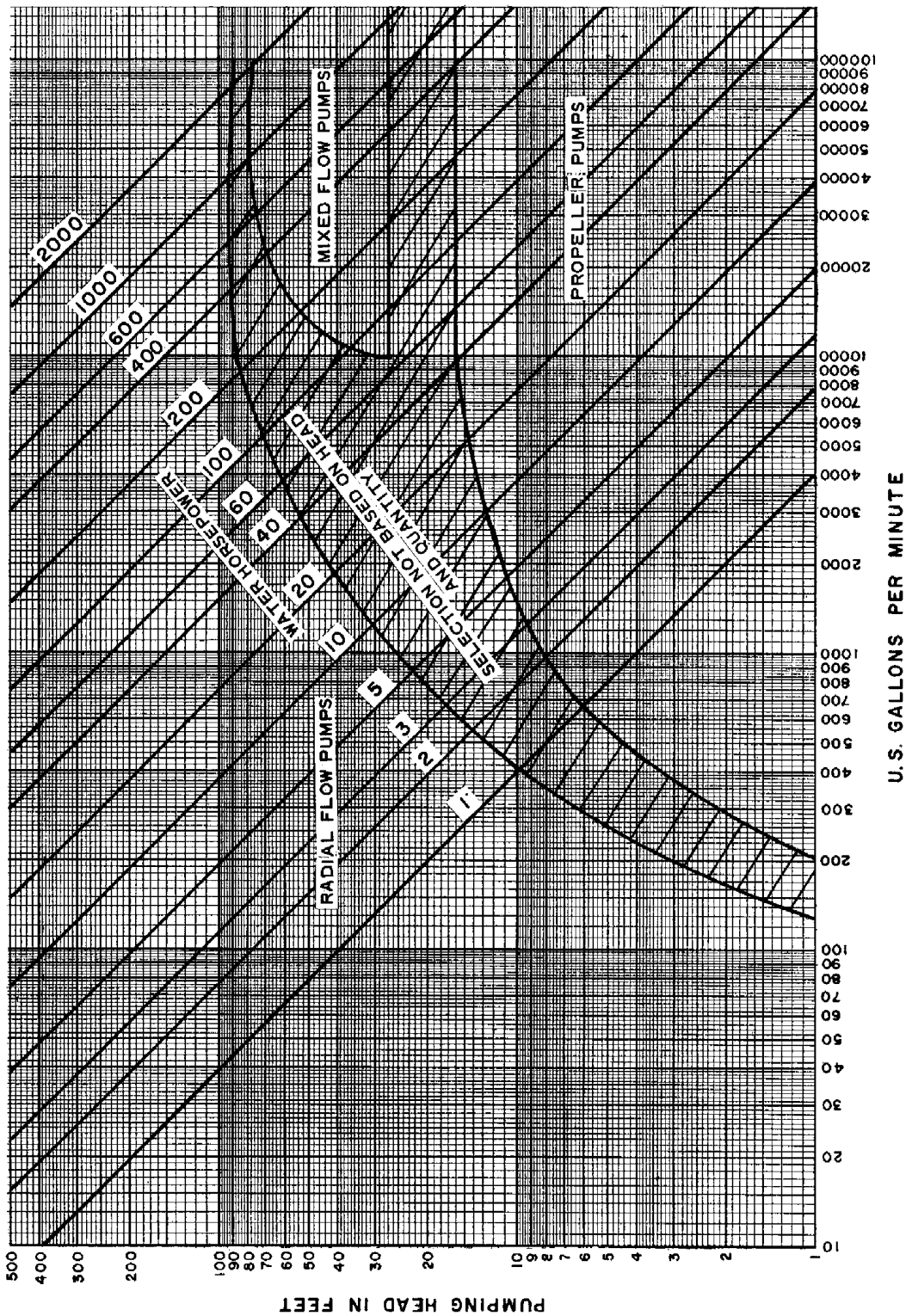

REFERENCE

U. S. DEPARTMENT OF AGRICULTURE
 SOIL CONSERVATION SERVICE
 ENGINEERING DIVISION - DRAINAGE SECTION

STANDARD DWG. NO.

ES - 724

SHEET 1 Of 1

DATE February 1971

Figure 7-4, Pump type selection chart

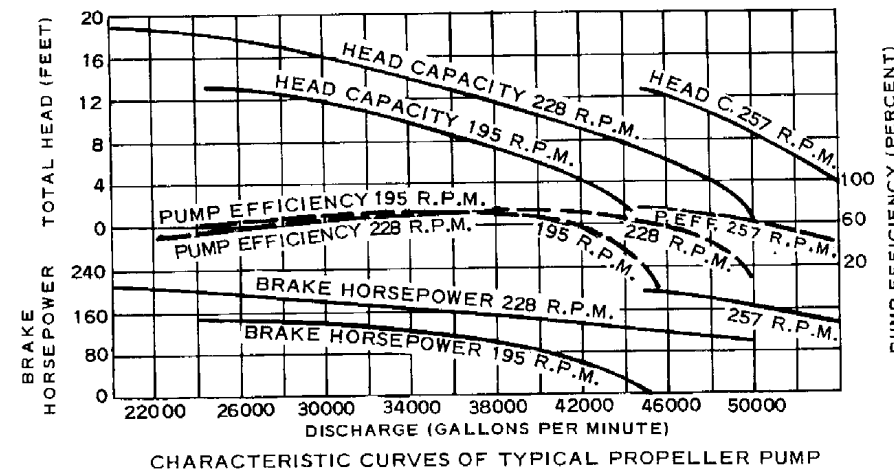
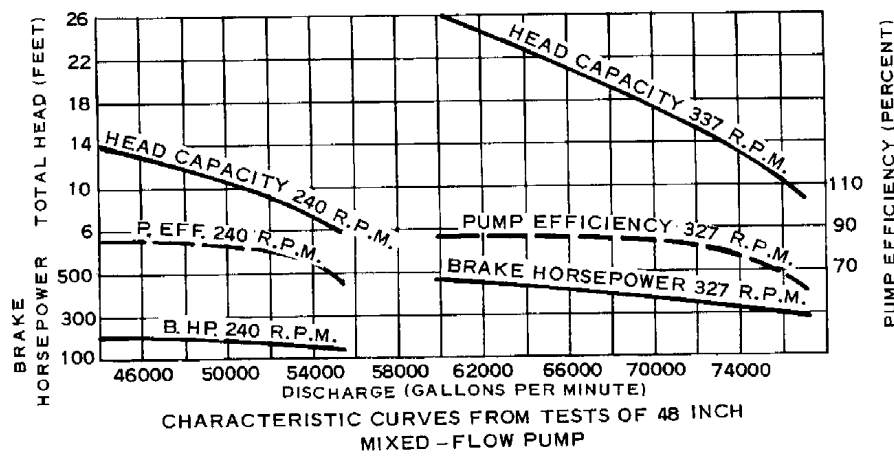
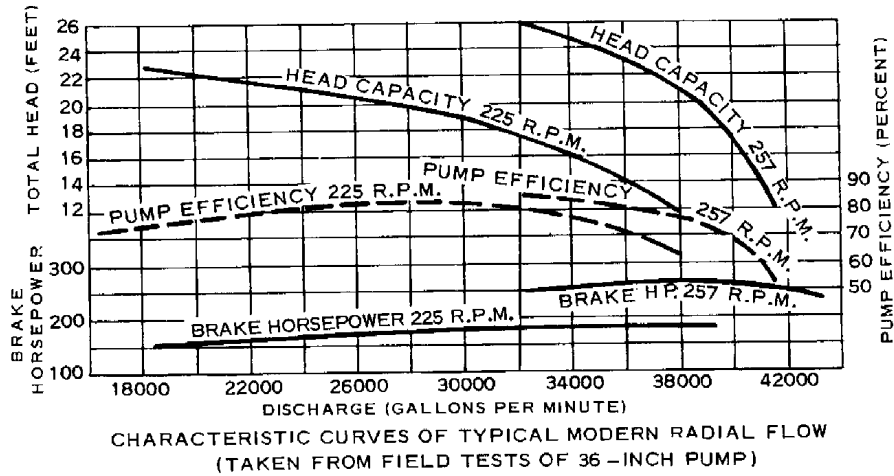

Reference:
USDA Bulletin 1008

Figure 7-5, Pump characteristic performance curves

g is acceleration due to gravity, equal to 32.16 feet per second per second.

Expressions $\frac{v_s^2}{2g}$ and $\frac{v_d^2}{2g}$ are velocity heads in the suction and discharge heads, respectively.

Actual internal head losses within the pump are hydraulic losses between the suction and discharge flanges. In well designed pumps these are quite small. They include disc friction and water shear in the sealing ring spaces; friction or shock in the volute or diffusion vanes of the impeller; and mechanical losses such as friction in the wearing ring and mechanical seal. An accounting of the head losses within pumps is usually covered by pump manufacturers' ratings.

Entrance, friction, and exit losses in the suction and discharge pipes dissipate a substantial part of the total energy used by the pumping plant.

Suction pipe head losses

Suction pipe head losses may be large unless proper attention is given to the shape and size of the suction pipe and the approach velocity of water entering the pipe, which is affected by the sump geometry and the effect of other pumps in the plant, if there is more than one pump.

Entrance losses at the suction entrance may be kept low by progressively expanding the diameter of the pipe from the pump flange toward the suction entrance or by flaring out the end of the suction entrance. Approach velocities in the sump to the suction pipe entrance should be kept under 3 feet per second. Normally, manufacturers provide a short suction pipe with flared entrance or bell on the vertical type axial flow and mixed flow pumps. Some manufacturers also add an umbrella or brim to the inlet edge to reduce further any entrance disturbance. Bells are often omitted on small propeller pumps made by local machine shops.

In order to avoid vortex action, flow in the sump toward the suction flange should be without swirls and ripples and as direct as possible. This is controlled primarily by the sump design and the maintenance of sufficient submergence over the suction bell so that vortex action does not develop. See criteria included under Sump Dimensions.

Net positive suction head (NPSH)

Net positive suction head is the total suction head in feet of liquid determined at the suction intake, corrected for datum and vapor pressure. Incorrect determination of NPSH can reduce pump capacity and efficiency and lead to cavitation damage.

$$\text{NPSH}_{(\text{available})} = h_{sv} = P_a - P_v + E - h_f \quad (\text{Eq. 7-4})$$

where P_a is atmospheric pressure at pump site in feet

P_v is water vapor pressure at operating temperature in feet

E is submergence of the pump intake in feet

h_f is suction losses in the suction pipe

P_a may be determined from table 7-1; P_v from table 7-2; E preferably from a manufacturer's pump catalog but also from (H-C) in figures 7-14 and 7-15; and h_f from the manufacturer's pump catalog. When the suction bell is attached directly to the suction bowl, losses are included in the manufacturer's pump curve and h_f then is not included in the equation. Temperature of drainage water will usually range between 50° and 70° F. and 60° is commonly used for design purposes.

For example: Given a Peerless pump with attached suction bell, 22,000 GPM capacity, installed at altitude of 4,000 feet, for water temperature of 60° F., determine the required NPSH (h_{sv}).

Referring to figure 7-15 and using value of E obtained from (H-C) in figure 7-14 for 22,000 GPM,

$$\begin{aligned} E &= (H-C) \\ &= 125 - 17 \\ &= 108 \text{ inches or } 9.0 \text{ feet} \end{aligned}$$

Referring to table 7-1, P_a for 4,000 feet = 29.2 and table 7-2 where P_v for 60° F. = 0.59,

$$\begin{aligned} h_{sv} &= P_a - P_v + E - h_f \\ &= 29.2 - 0.6 + 9.0 - 0 \\ &= 37.6 \text{ feet} \end{aligned}$$

Peerless model studies show that submergence of 6 feet 1 inch is sufficient to prevent vortexing. Thus the calculated net positive suction head indicates E could be substantially less than that used.

Discharge pipe losses

Discharge pipe losses include friction and exit losses. Losses can be computed from data in NEH Section 5, Hydraulics (8) or King and Brater's Handbook of Hydraulics (9). Friction losses in the discharge pipe can be reduced greatly by use of larger diameter pipe, usually 2 to 6 inches larger than the pump discharge flange. The transition can be made through a short expanding section of pipe at the pump flange. Figure 7-6 can be used to determine friction losses in steel pipe generally used for discharge pipe from drainage pumps. Head loss values in the chart are for riveted pipe and should be reduced 30 percent for welded steel or sheet metal pipe.

For example: Given a 20,000 GPM discharge through a 36-inch diameter pipe, determine the velocity head, velocity, and head loss.

Establish a reference point by entering chart in figure 7-6 at 20,000 GPM on left-hand vertical scale and moving horizontally across to intercept the discharge curve for the 36-inch pipe. Next, move vertically upward from the reference point to the velocity head curve and thence horizontally to the upper right-hand vertical scale. The velocity head is shown as 0.6 foot. Next, from the reference point move vertically downward to the bottom horizontal scale. Velocity is shown as 6.25 fps. Again from the reference point move vertically downward to intercept the head loss curve for the 36-inch pipe and thence horizontally to the lower right-hand vertical scale. The head loss is shown as 0.5 foot per 100 feet.

Table 7-1, Properties of water at various altitudes

| Altitude Feet | Barometric Pressure | | Atmospheric Pressure | |
|------------------|---------------------|--|----------------------|------------|
| | Inches Hg | | psia | Feet Water |
| -500 | 30.5 | | 15.0 | 34.6 |
| 0 (Seasonal) | 29.9 | | 14.7 | 33.9 |
| 500 | 29.4 | | 14.5 | 33.4 |
| 1,000 | 28.9 | | 14.2 | 32.8 |
| 1,500 | 28.3 | | 13.9 | 32.1 |
| 2,000 | 27.8 | | 13.7 | 31.5 |
| 4,000 | 25.8 | | 12.7 | 29.2 |
| 6,000 | 24.0 | | 11.8 | 27.2 |
| 8,000 | 22.2 | | 10.9 | 25.2 |

Table 7-2, Properties of water at various temperatures

| Temperature Degrees F. | Vapor Pressure | | Specific Weight pcf | Specific Gravity |
|---------------------------|----------------|------------|------------------------|------------------|
| | psfa | Feet Water | | |
| 32.0 | 12.7 | 0.20 | 62.42 | .9999 |
| 39.2 ^{1/} | 16.9 | 0.27 | 62.427 | 1.0000 |
| 50.0 | 25.6 | 0.41 | 62.41 | .9997 |
| 60.0 | 36.8 | 0.59 | 62.37 | .9990 |
| 70.0 | 52.3 | 0.84 | 62.30 | .9980 |
| 80.0 | 73.0 | 1.17 | 62.22 | .9966 |
| 100.0 | 136.0 | 2.19 | 62.00 | .9931 |

^{1/} Temperature when specific gravity = 1.0000

VELOCITY HEAD, DISCHARGE, AND FRICTION-HEAD LOSS IN RIVETED STEEL PIPES

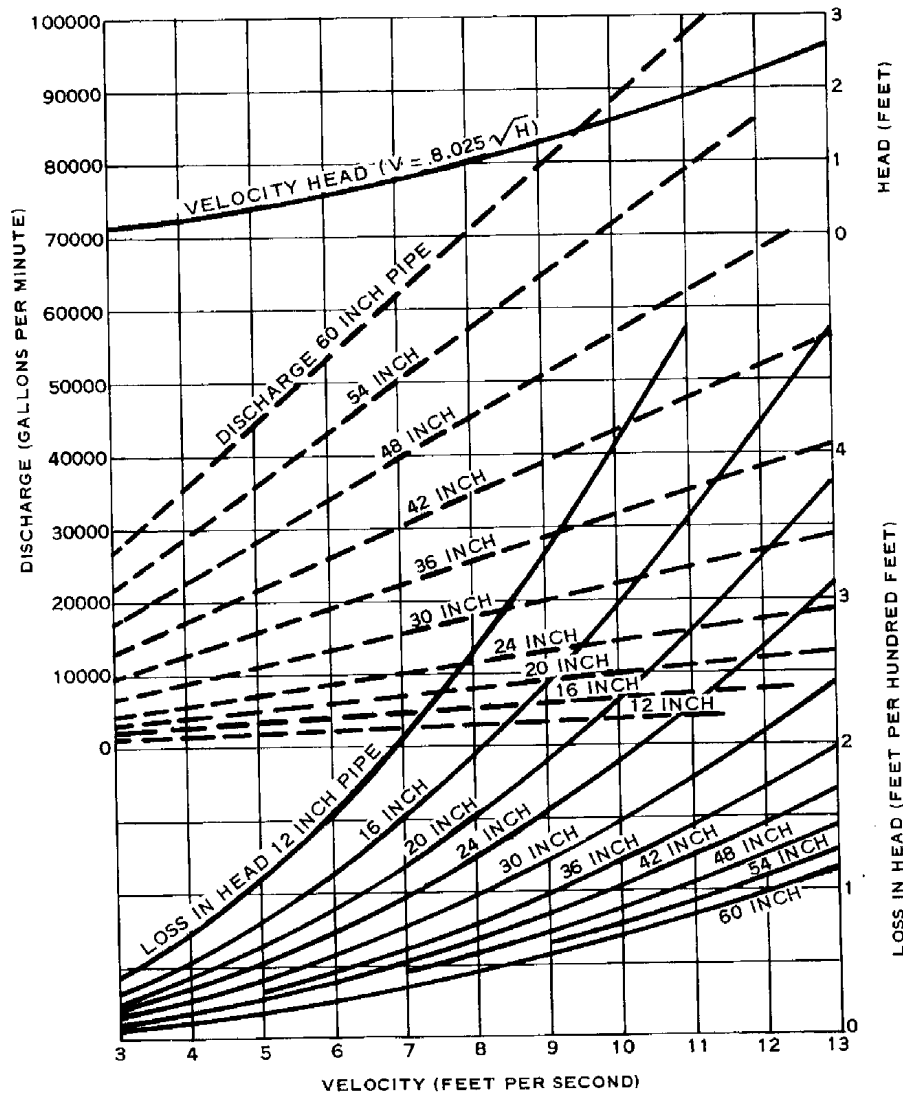

VELOCITY HEAD, DISCHARGE, AND FRICTION-HEAD LOSS IN RIVETED STEEL PIPES

Loss in head based on Scobey's formula

$$H = K_s \frac{V^{1.9}}{D^{1.1}} \quad \text{where } K_s = 0.51$$

For welded steel or for sheet metal pipe $\frac{3}{16}$ " or less thickness, reduce head loss 30 percent.

REFERENCE
U.S.D.A. Bulletin 1008

U.S. DEPARTMENT OF AGRICULTURE
SOIL CONSERVATION SERVICE
ENGINEERING DIVISION - DRAINAGE SECTION

STANDARD DWG. NO.
ES - 725
SHEET 1 Of 1
DATE February 1971

Figure 7-6, Head losses in riveted steel pipe

Head loss through a standard flap gate is quite low. Figure 7-7 contains values for various size gates and discharges based on tests carried out a number of years ago at the University of Iowa Hydraulics Laboratory by Floyd A. Nagler (10).

Specific speed

Specific speed expresses a relationship of head, capacity, and speed with respect to the suction lift. High speeds without proper suction conditions can cause serious trouble from vibrating noise and pitting. The maximum head in a single stage impeller is determined by the impeller diameter which establishes the peripheral speed and by the strength of the metal in the impeller casing to withstand such peripheral speed. Ordinarily, manufacturers limit peripheral speed to about 900 feet per minute to meet requirements of impeller castings normally used. By use of special high strength metals, impellers have been developed to withstand peripheral speeds beyond 14,000 feet per minute.

The Hydraulic Institute has defined specific speed and established standards which set upper limits of specific speed with respect to head, capacity, and suction lift as they apply to centrifugal pumps (1). Under normal circumstances, adherence to these standards assures freedom from cavitation. See figures 7-8, 7-9, 7-10, and 7-11. Figure 7-8 illustrates the characteristic profiles of several types of pump impellers ranging from the low specific speed radial flow designs to the high specific speed axial flow designs and their general location on the specific speed scales. Specific speed is defined as the revolutions per minute to which a geometrically similar impeller would run if it were of such size as to discharge 1 gallon per minute against 1 foot head. Specific speed, designated by the symbol N_s , can be determined from the following formula:

$$N_s = \frac{N\sqrt{Q}}{H^{3/4}} \quad \text{or} \quad N_s = \frac{N\sqrt{Q} H^{1/4}}{H} \quad (\text{Eq. 7-5})$$

where

- N = rotative speed in revolutions per minute
- Q = flow in gallons per minute at optimum efficiency
- H = total head in feet (total discharge head plus total suction lift)

and Suction Specific Speed, designated as S from

$$S = \frac{N\sqrt{Q}}{h_{sv}^{3/4}} \quad \text{or} \quad S = \frac{N\sqrt{Q} h_{sv}^{1/4}}{h_{sv}} \quad (\text{Eq. 7-6})$$

where N and Q are the same as above

h_{sv} = required NPSH in feet.

A pump with a high suction lift, say over 15 feet, requires special consideration in the pump design. This usually results in slow speeds and large pumps. If suction lifts can be reduced, smaller and cheaper pumps can be used.

HEAD LOSSES FOR LIGHT FLAP GATES

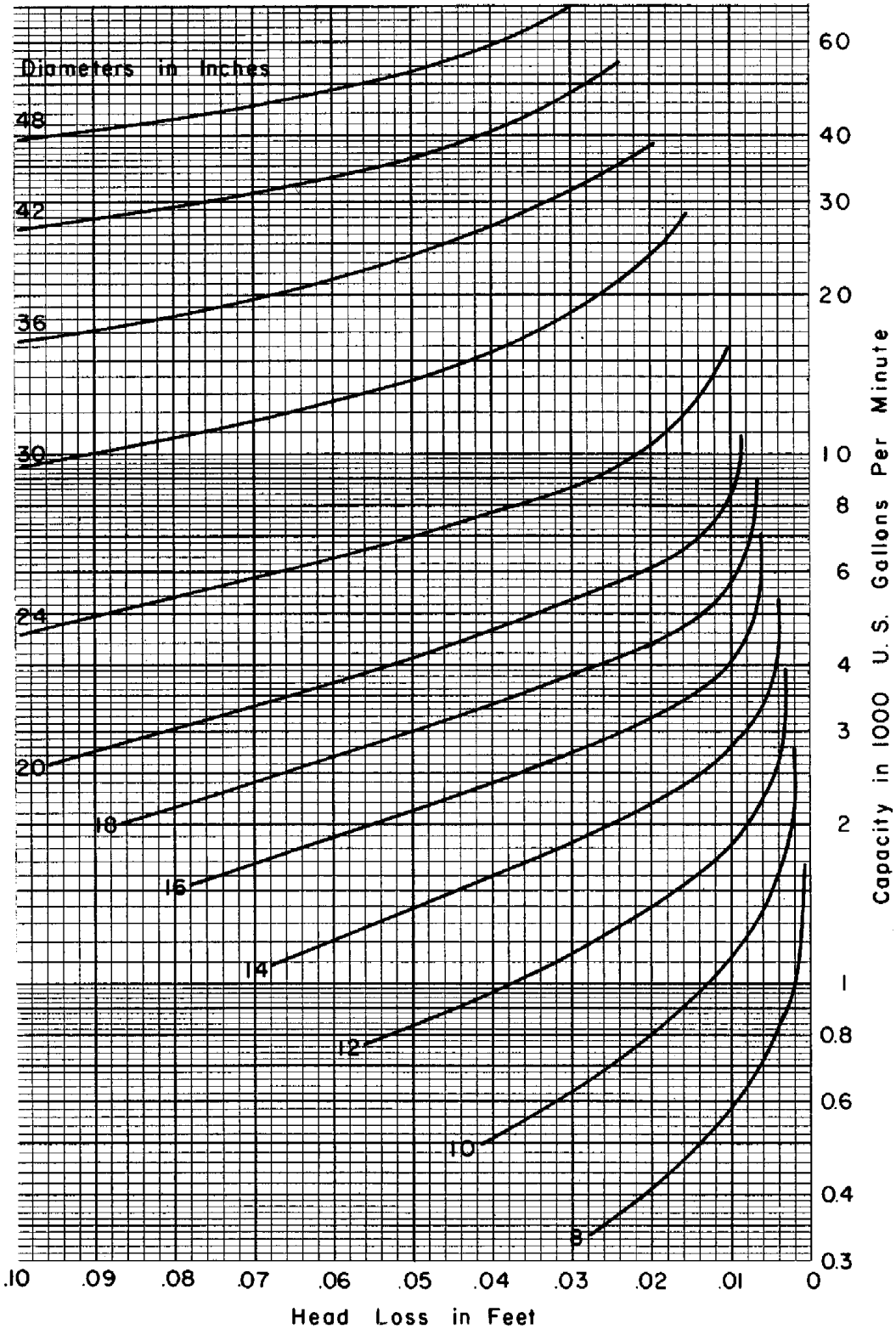

REFERENCE
 Handbook of Water Control
 1936 Edition
 W.Q. O'Neill Co
 Chicago, Illinois

U.S. DEPARTMENT OF AGRICULTURE
 SOIL CONSERVATION SERVICE
 ENGINEERING DIVISION - DRAINAGE SECTION

STANDARD DWG. NO.
 ES - 726
 SHEET 1 of 1
 DATE February 1971

Figure 7-7, Head losses for light flap gates

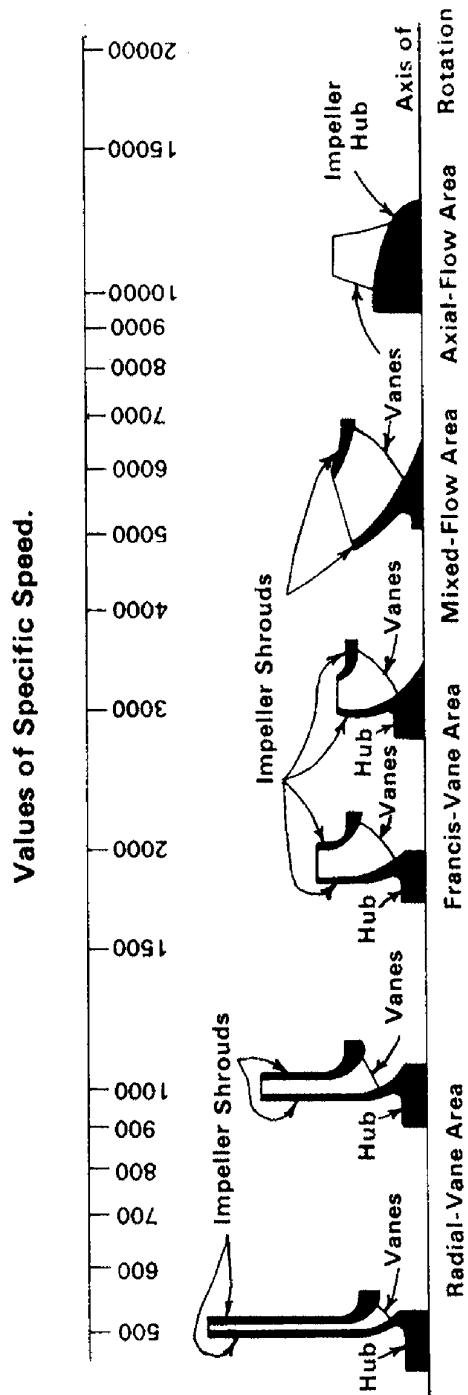
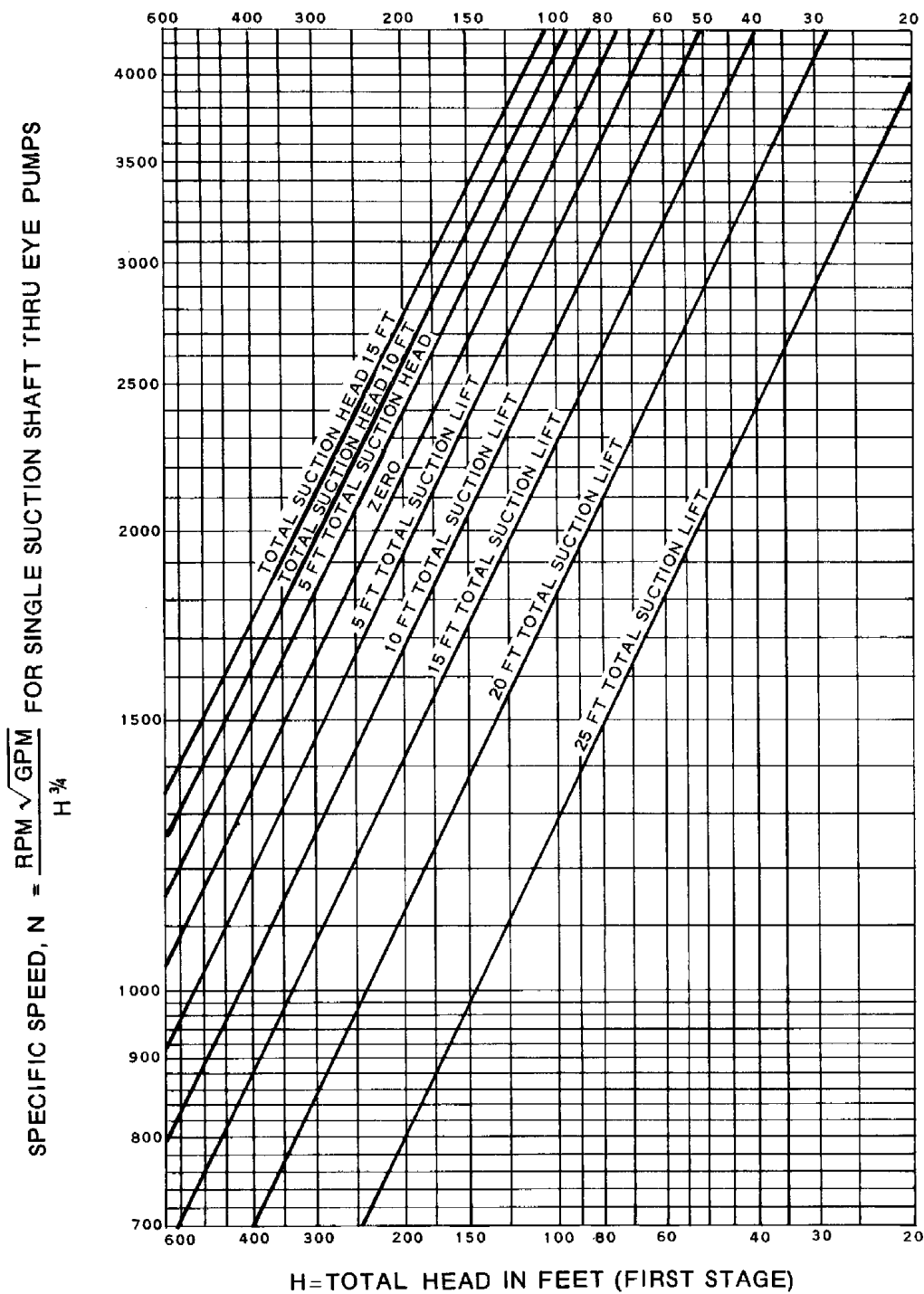

Figure 7-8, Relationship of impeller design and specific speeds

UPPER LIMITS OF SPECIFIC SPEEDS SINGLE SUCTION SHAFT THRU EYE PUMPS HANDLING CLEAR WATER AT 85° F AT SEA LEVEL



REFERENCE: Reprinted from Hydraulic Institute Standards 12th Edition. Copyright 1969 by the Hydraulic Institute, 122 East 42nd St. New York, New York 10017

U. S. DEPARTMENT OF AGRICULTURE
SOIL CONSERVATION SERVICE
ENGINEERING DIVISION - DRAINAGE SECTION

STANDARD DWG. NO.
ES - 727
SHEET 1 Of 3
DATE February 1971

Figure 7-9, Limits of specific speed, single suction, radial and mixed flow pumps

UPPER LIMITS OF SPECIFIC SPEEDS DOUBLE SUCTION PUMPS HANDLING CLEAR WATER AT 85° F AT SEA LEVEL

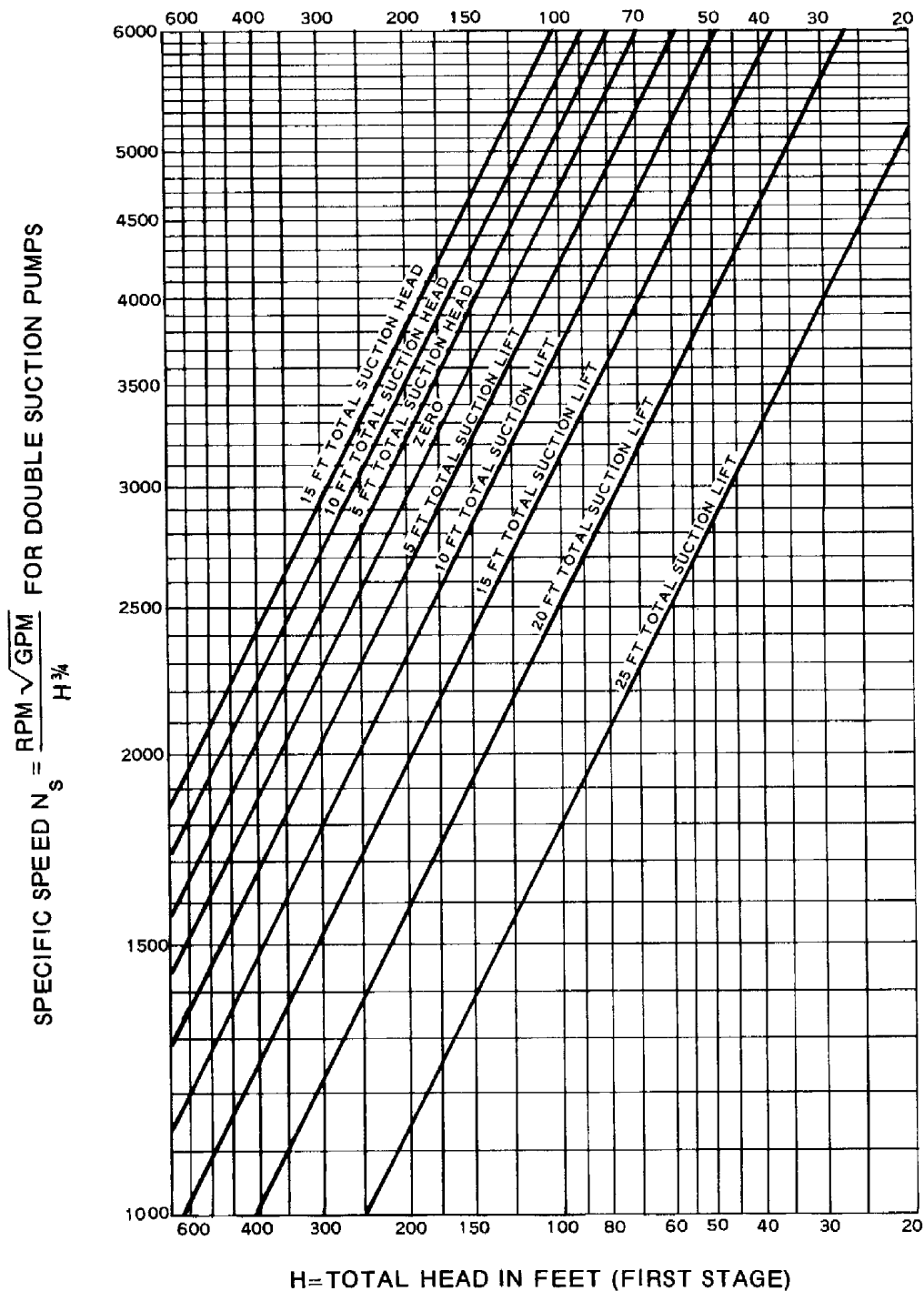

REFERENCE: Reprinted from Hydraulic Institute Standards 12th Edition. Copyright 1969 by the Hydraulic Institute, 122 East 42nd St. New York, New York 10017

U. S. DEPARTMENT OF AGRICULTURE
SOIL CONSERVATION SERVICE
ENGINEERING DIVISION - DRAINAGE SECTION

STANDARD DWG. NO.
ES - **727**
SHEET 2 Of 3
DATE February 1971

Figure 7-10, Limits of specific speed, double suction, radial flow pumps

UPPER LIMITS OF SPECIFIC SPEEDS SINGLE SECTION, MIXED AND AXIAL FLOW PUMPS HANDLING CLEAR WATER AT 85° F AT SEA LEVEL

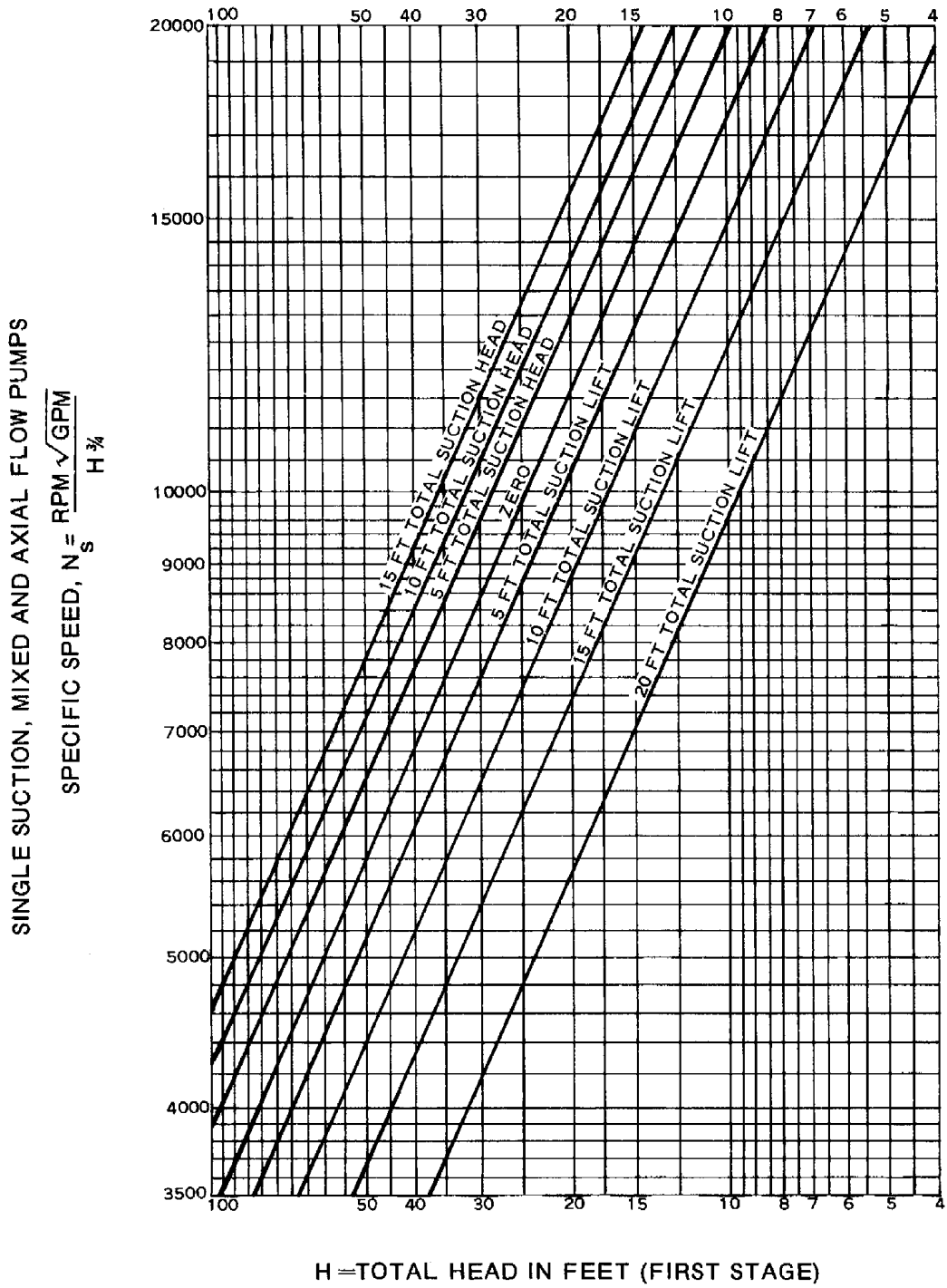

REFERENCE: Reprinted from Hydraulic Institute Standards 12th Edition. Copyright 1969 by the Hydraulic Institute, 122 East 42nd St. New York, New York 10017

U. S. DEPARTMENT OF AGRICULTURE
SOIL CONSERVATION SERVICE
ENGINEERING DIVISION - DRAINAGE SECTION

STANDARD DWG. NO.
ES - **727**
SHEET **3 Of 3**
DATE **February 1971**

Figure 7-11, Limits of specific speed, single suction, mixed and axial flow pumps

Table 7-3 provides a useful guide for classifying pumps according to specific speed and the magnitude of pressure.

Table 7-3, Pump classification according to speed and pressure magnitude

| N_s | Constant Speed and Capacity | Constant Speed and Pressure | Constant Capacity and Head | Head Range (in feet) | Type Pump |
|-----------------------|-----------------------------|-----------------------------|----------------------------|----------------------|--|
| Low 2,000 | high pressure | low capacity | low speed | 200+ | Radial or partial Francis type centrifugal |
| Medium 1,500-5,000 | medium pressure | medium capacity | medium speed | 20 to 200 | Radial and Francis type centrifugal |
| High 4,000-9,000 | low pressure | high capacity | high speed | 10 to 90 | Mixed flow or propeller |
| 8,000-20,000 | | | | 3 to 20 | Propeller |

Pump size

Pump size should be based on heads and speeds when the pumps are operating at or near maximum efficiency. Discharge velocities under these conditions will range between 9 and 13 feet per second for a properly sized pump. For purposes of establishing approximate size in the preliminary design of drainage pumping plants, 10 feet per second can be taken as most commonly applicable. The required pump size can then be computed by dividing the required capacity by the average discharge velocity selected. Table 7-4 gives pump sizes for various capacities and discharge velocities. With the pump size and static lift established, approximate suction and discharge heads can be computed.

Pump size can be determined on the basis of specific speeds from performance curves of tested prototypes or prototype models. These should be available for various types and sizes from leading pump manufacturers, government agencies such as the Corps of Engineers, Bureau of Reclamation, Soil Conservation Service, and others. Additional tests of performance should not be necessary except in unusual circumstances.

In the case of small pumps tests may be made directly. In the case of large pumps tests on similar small models can be made. Then, based on specific speeds and performance of such prototypes, the characteristics of the large pumps can be established accurately from the characteristic curve of size, speed, and submergence of the model. In most cases these are more accurately determined from direct field tests of a prototype because of the difficulty of obtaining accurate field test measurements when large volumes of water are involved. Model tests must duplicate closely the flow conditions in both suction and discharge to provide reliable prototype characteristics.

The following are the basic equations given by the Hydraulic Institute to correlate model and prototype values.

PUMP SIZE, CAPACITY AND DISCHARGE RATES

| Pump Size Inches | 9 | 10 | 11 | 12 | 13 |
|---------------------|---|----|----|----|----|
|---------------------|---|----|----|----|----|

PUMP CAPACITY - CUBIC FEET PER SECOND

| | | | | | |
|----|-------|-------|-------|-------|-------|
| 10 | 5.0 | 5.5 | 6.1 | 6.6 | 7.2 |
| 12 | 7.1 | 7.9 | 8.7 | 9.5 | 10.3 |
| 14 | 9.6 | 10.7 | 11.8 | 12.8 | 13.9 |
| 16 | 12.6 | 14.0 | 15.4 | 16.8 | 18.2 |
| 18 | 15.9 | 17.7 | 19.5 | 21.2 | 23.0 |
| 20 | 19.6 | 21.8 | 24.0 | 26.2 | 28.3 |
| 22 | 23.8 | 26.4 | 29.0 | 31.7 | 34.3 |
| 24 | 28.3 | 31.4 | 34.5 | 37.7 | 40.8 |
| 26 | 33.2 | 36.9 | 40.6 | 44.3 | 48.0 |
| 28 | 38.5 | 42.8 | 47.1 | 51.4 | 55.6 |
| 30 | 44.2 | 49.1 | 54.0 | 58.9 | 63.8 |
| 36 | 63.6 | 70.7 | 77.8 | 84.8 | 91.9 |
| 42 | 86.6 | 96.2 | 105.8 | 115.4 | 125.1 |
| 48 | 113.1 | 125.7 | 138.3 | 150.8 | 163.4 |
| 54 | 143.1 | 159.0 | 174.9 | 190.8 | 206.7 |
| 60 | 176.7 | 196.3 | 215.9 | 235.6 | 255.2 |

| Pump Size Inches | 9 | 10 | 11 | 12 | 13 |
|---------------------|---|----|----|----|----|
|---------------------|---|----|----|----|----|

PUMP CAPACITY - GALLONS PER MINUTE

| | | | | | |
|----|--------|--------|--------|---------|---------|
| 10 | 2,245 | 2,470 | 2,739 | 2,963 | 3,233 |
| 12 | 3,188 | 3,547 | 3,906 | 4,266 | 4,625 |
| 14 | 4,310 | 4,804 | 5,298 | 5,747 | 6,241 |
| 16 | 5,657 | 6,286 | 6,915 | 7,543 | 8,172 |
| 18 | 7,139 | 7,947 | 8,756 | 9,519 | 10,327 |
| 20 | 8,800 | 9,788 | 10,776 | 11,764 | 12,707 |
| 22 | 10,686 | 11,854 | 13,021 | 14,233 | 15,401 |
| 24 | 12,707 | 14,099 | 15,491 | 16,927 | 18,319 |
| 26 | 14,907 | 16,568 | 18,229 | 19,891 | 21,552 |
| 28 | 17,286 | 19,217 | 21,148 | 23,079 | 24,964 |
| 30 | 19,846 | 22,046 | 24,246 | 26,446 | 28,646 |
| 36 | 28,556 | 31,744 | 34,932 | 38,075 | 41,263 |
| 42 | 38,883 | 43,194 | 47,504 | 51,815 | 56,170 |
| 48 | 50,782 | 56,439 | 62,097 | 67,709 | 73,367 |
| 54 | 64,252 | 71,391 | 78,530 | 85,669 | 92,804 |
| 60 | 79,338 | 88,139 | 96,939 | 105,784 | 114,585 |

REFERENCE

U. S. DEPARTMENT OF AGRICULTURE
SOIL CONSERVATION SERVICE
ENGINEERING DIVISION - DRAINAGE SECTION

STANDARD DWG. NO.

ES - 728

SHEET 1 Of 1

DATE February 1971

Table 7-4, Pump size according to capacity and discharge velocity

If M represents the model and P the prototype then

$$\frac{\text{Specific Speed of M}}{\text{Specific Speed of P}} = \frac{\text{Diameter of P}}{\text{Diameter of M}} \cdot \sqrt{\frac{\text{Head of M in feet}}{\text{Head of P in feet}}}$$

and

$$\frac{\text{Capacity of M in GPM}}{\text{Capacity of P in GPM}} = \frac{\text{Diameter of M}}{\text{Diameter of P}} \cdot \sqrt{\frac{\text{Head of M}}{\text{Head of P}}}$$

Power and drives

Both electric motors and internal combustion engines are used as power units for drainage pumps. Primary considerations in selecting power equipment for drainage pumps are reliability of operation during times when pumps must be used, availability of power and fuel, initial and operation cost, annual use, and frequency and duration of pumping.

Electric motors

Electric motors are frequently preferred because of their simplicity and low upkeep. Vertical types are well suited to most drainage installations. Usually they can be connected directly to pumps without special transmission units and require little building space. Also, electric motors are easily adapted to automatic controls. However, consideration must be given to the possibility of discontinuance or interruption of power during severe storms. Also, power costs, both installation and operation, may be excessive, particularly in rural areas where high voltage lines are not readily available. Power costs may include both a primary charge based on capacity of the electric motors and a current charge based on the amount of current used. When the primary charge is the greater part of power costs, plant efficiency becomes less important than when a high kilowatt-hour charge is made.

Either a squirrel-cage (induction) or synchronous motor can be used for powering drainage pumps. These are obtainable in sizes and speed ranges meeting most needs. A squirrel-cage motor is the cheapest type of motor and is almost universally used on small to medium sized pumping installations using electric power. A synchronous motor is more costly but also slightly more efficient than the squirrel cage, requires less exact alignment on the shaft, and the power factor can be kept constant or varied. See figure 7-12 for generalized application ranges for two types of motors. Final selection should be based on a motor manufacturer's recommendations.

Starting torques are low on centrifugal pumps of the nonclog type. Starting torques are high on fixed blade propeller and mixed flow pumps and they are higher than the full load torque after the pumps are in operation. When limitations in starting current exist, or voltage regulation on incoming current is poor, squirrel cage motors, which have low starting torques cannot be used for the larger sizes of axial flow pumps except when such pumps have adjustable blades or when they are volute type pumps for which water can be depressed below the impeller during the pump start. In synchronous motors starting torques also depend upon a squirrel cage winding which is necessary in the initial stages of motor excitation and may cause high momentary loads in the powerline. Capacitors can be installed in the motors to adjust for incoming line voltage drops.

MOTOR SELECTION CHART

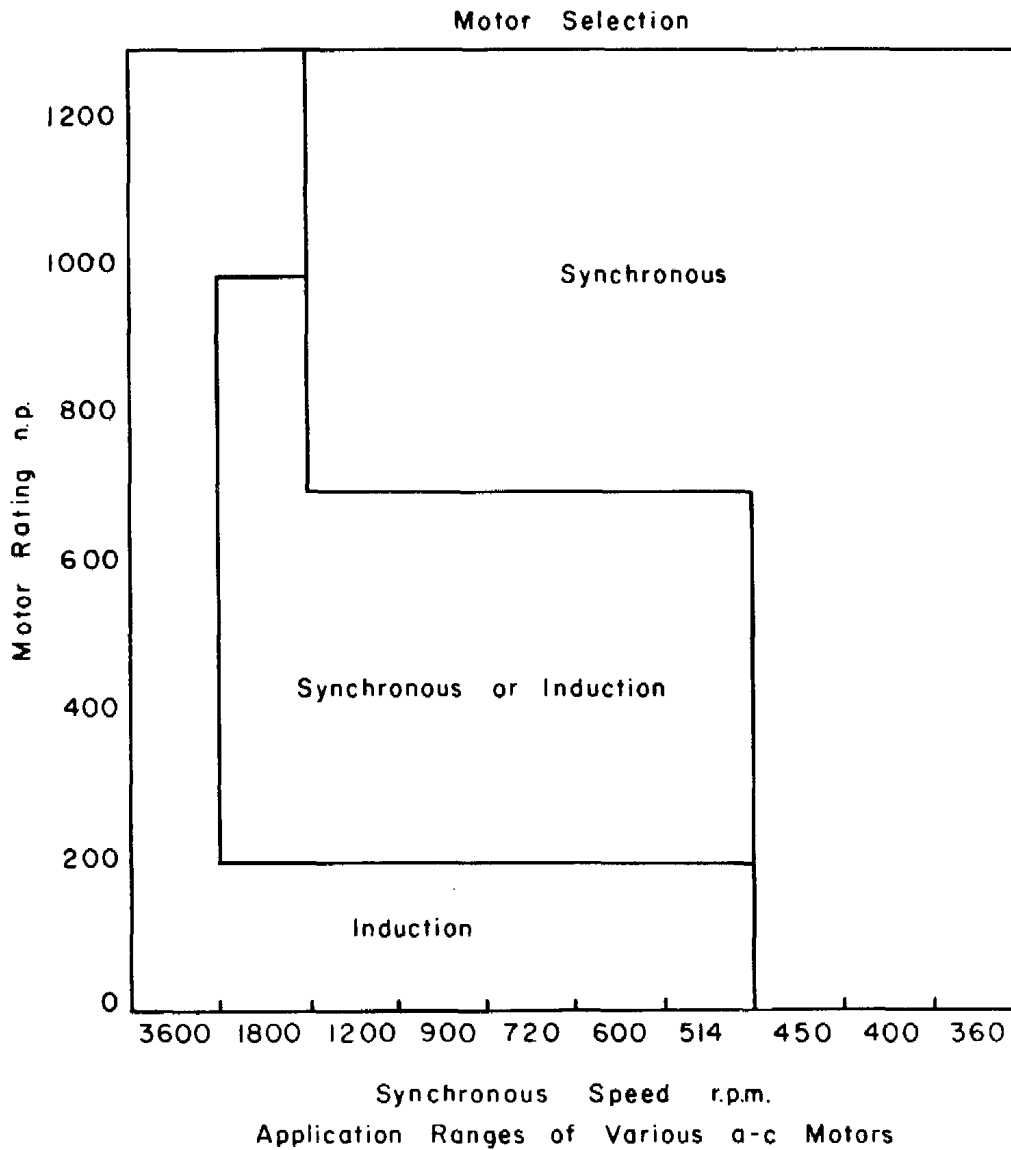

REFERENCE

Pump Selection and Application by T. G. Hicks, page 308, McGraw - Hill

U. S. DEPARTMENT OF AGRICULTURE
SOIL CONSERVATION SERVICE
ENGINEERING DIVISION - DRAINAGE SECTION

STANDARD DWG. NO.

ES - 729

SHEET 1 of 1

DATE February 1971

Figure 7-12, Motor selection chart

Internal combustion engines

Internal combustion engines may be gasoline, fuel gas, or diesel powered. Commercially available gasoline engines usually provide the lowest overall cost although operating cost is usually high. Diesel or fuel gas operation is usually more economical when annual operation exceeds 800 hours. Internal combustion engines are advantageous in that they can be operated at variable speeds, and with adequate fuel storage facilities are reasonably free from supply hazards of delivery failures during storms. Less deterioration occurs and less frequent engine check runs are necessary in diesel than gasoline units when long standby intervals occur between pump operations.

Power drives

Power drives for drainage pumps may be by direct connection, 90-degree gearbox, V or flat belt, and tractor power takeoff. Direct drive is limited to direct hookup of motor and pump with the same operating speeds. Hookup is by direct or flexible coupling and no loss in power is obtained. The gearbox is the most dependable and commonly used transmission for the vertical pumps and internal combustion engines. Combinations of gears are provided to permit both pump and engine to be operated at their most efficient speeds. Power loss through such connections is 5 percent or less. Multiple V belt drives, though less costly than the gearbox, are slightly less efficient with the power loss ranging from 5 to 10 percent. They are much more efficient than flat belts and can be operated satisfactorily in confined space with only short distances between pulleys. Flat belts are the least efficient, ranging from 20 to 30 percent power loss, depending upon the pulley type and size, slippage, and twist. They can be used with small pumps employing farm tractors for power. Tractor power takeoffs can be used in place of the flat belts but may require some gear or pulley type speed interchanging device to match the operating speed of the pump. There is usually a power loss of 10 to 15 percent in the gearing within the tractor.

Power requirements

The capacity of the power units is measured in horsepower. One horsepower is equal to 33,000 foot-pounds per minute, 2,545 BTU per hour, or 0.746 kilowatts.

Water horsepower (WHP) is the required output of the pumps.

$$\text{WHP} = \frac{QwH_t}{33,000}$$

where Q is discharge in gallons per minute
w is the weight of water in pounds per gallon
and H_t is total head of water in feet

$$\text{WHP} = \frac{Q H_t}{3,960} = 0.0002526 Q H_t \quad (\text{Eq. 7-7})$$

when weight of water at 68° F. is 8.34 pounds per gallon

Brake horsepower (BHP) is the power input of the pumps or is the required output of engines or motors, including power losses in power units and pumps.

$$\text{BHP} = \frac{\text{WHP}}{e_p e_t e_m}$$

where e_p is the efficiency of the pump, e_t the efficiency of transmission of power between engine or motor and pump, and e_m the efficiency of the engine or motor

therefore

$$\text{BHP} = \frac{0.0002526 Q H_t}{e_p e_t e_m} \quad (\text{Eq. 7-8})$$

Performance curves indicating engine and motor characteristics are available from most manufacturers. Performance curves are determined from dynamometer tests. Tests on engines usually are based on stripped down units without mufflers, cooling fans, etc. Loss of power from these accessories plus effects of continuous application of loads may require an approximate 20 percent increase in horsepower requirements over that shown by the manufacturer.

In estimating required horsepower to be used by the pumping units, efficiency of the several unit components (when in good condition and operated at rated capacity) can be taken as 90 percent for electric motors, 80 percent for diesel engines, 70 percent for water-cooled gas engines, 60 percent for air-cooled gas engines, 100 percent for direct connected transmission, 95 percent for gearbox transmission, 90 percent for V belt transmission, 80 percent for flat belt transmission, and between 65 and 80 percent for pumps.

For example, determine the required horsepower of a water-cooled gas engine, gearbox connected to a 10,000 GPM propeller pump operated at a 10-foot total head. The manufacturer's rating curve for the pump indicates an efficiency of 79 percent.

$$\begin{aligned} \text{BHP} &= \frac{0.0002526 \times 10,000 \times 10}{0.79 \times 0.95 \times 0.70} \\ &= \frac{25.26}{0.525} = 50 \end{aligned}$$

Thus an engine of rated horsepower twice water horsepower is required.

Since the pumping unit should operate satisfactorily under all operating conditions, characteristics of both pump and power unit should be considered for starting load, load at shutoff, and load for total heads less than the maximum.

Operating controls

Both automatic and manual controls may be used in the operation of drainage pumping facilities. Alternate manual controls must be provided where automatic controls are used.

The use of automatic start and stop controls are well suited to installations where short operating cycles are necessary, where the installation is remote, and where there is a shortage of competent operators. Automatic controls may deteriorate due to long periods of disuse and thus require frequent inspections and maintenance to assure good operation.

Short cycling as the result of water surface drawdown or water oscillation in the sump can be prevented by at least two methods. In the first method, locate the water level sensing device far enough upstream from the pumps so

that it is unaffected by local drawdown. In the second method, set the on-off levels sufficiently far apart so that local drawdown will not turn pumps off. If a minimum water level fluctuation is required, the first method is most suitable. If some fluctuation is allowable, the second method may be used.

Many devices are available for sensing water depths for automatic control. Among the most common are float type switches, electrodes, bubbler tubes, bells, and diaphragms. There are other electric sensors available, but they have not been widely adopted for drainage work.

In some locations, openings to automatic controls require screening against entry of small rodents or insects such as "mud" wasps, whose construction of nests in the equipment may prevent the functioning of the controls.

In areas where low temperatures are experienced protection against freezing may be necessary, such as a hinged gate or curtain enclosure of the sump opening above the waterline and heated well housing for float controls.

Float activated switches are perhaps the most common type of control used. The basic operation is that a float is suspended by a stainless steel tape which travels over a sheave to a counterweight. The sheave is connected to the meter switches. A change in the water surface elevation changes the position of the sheave, thus activating the switch. See figure 7-13. Adjustment of the water level settings are made at the switch. The float, tape, and counterweight are vulnerable to damage by debris, ice, and vandalism, thus enclosure in a well is usually necessary. The tape, sheave, and float must be of stainless steel or other corrosion resistant material. Algae, moss, and scum can foul the float and tape and prevent proper operation of the pumps. There is a definite physical limitation on how remote the switch can be from the float.

Electrodes are now used widely as controls. The basic operation is that the changing level of water completes or breaks electrical circuits, thus activating relays controlling the pumps. See figure 7-13 for a simplified schematic diagram. When the water level contacts the start electrode a complete circuit will occur through the relay through the water to the ground. The relay will close both contacts, starting the pump and also completing a "lock-in" circuit through the relay, the relay contact, and the water to the ground. Pumping will continue when the water level drops below the start relay because of the "lock-in" circuit. When the water level drops below the stop electrode the "lock-in" circuit is broken and the relay contacts open, stopping the pump. The relay will not be energized when the water level reaches the stop electrode because the relay contact is open. The cycle described will repeat when the water level reaches the start electrode. There are no moving parts in the water, therefore the chance of damage is less than for a float system. The electrodes can be placed remotely from the relay. Systems are available using very low voltage thus eliminating any chance of accidental shock. To change water level settings it is necessary to move the electrodes. Experience to date indicates electrodes currently available may become defective after several years in use and should be tested periodically to determine need for replacement.

The bubbler tube system is widely used in sewage treatment applications because of the inherent nonclogging operation. See figure 7-13 for a simplified diagram of operation. Air, or other gas, is bubbled slowly at a constant rate of flow through a small tube and discharged freely into the water at a fixed elevation. The pressure within the tube is that due to the depth of water

Motor Control Switches

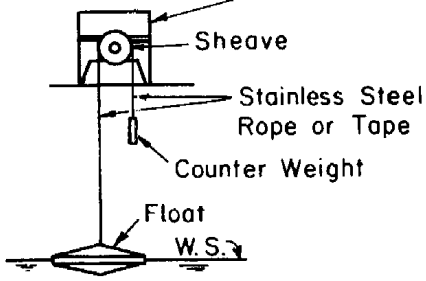

FLOAT CONTROL

To Power Supply

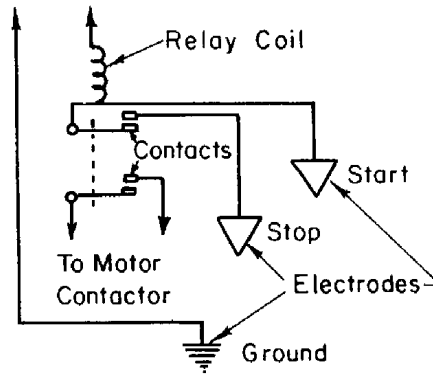

ELECTRODE CONTROL

Pressure Switch

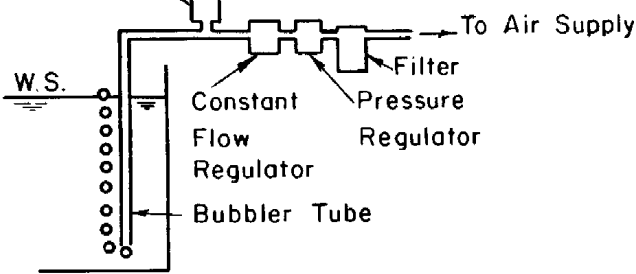

BUBBLER CONTROL

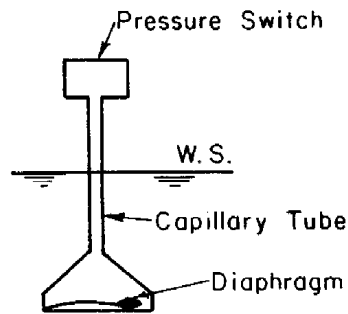

DIAPHRAGM CONTROL

Pressure Switch

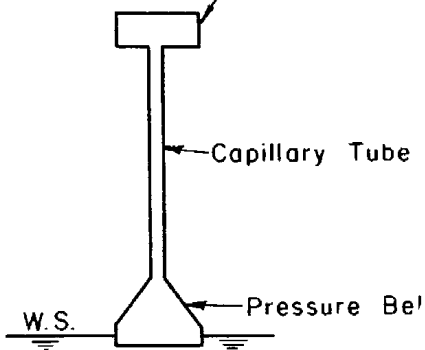

BELL CONTROL

Figure 7-13, Types of automatic control

over the end of the bubble tube. The pressure in the tube can vary as the water depth above the orifice varies. The air is supplied by an air compressor to a pressure tank. From the pressure tank the air passes through filters to remove oil, dirt, and water. A pressure reducing valve lowers the air pressure to a value which is slightly greater than that required for air flow at the maximum water level. The air then passes through a flow regulator valve which maintains a constant bubble rate regardless of the back pressure from the river. The air then passes the pressure activated switch and bubbles from the end of the bubble tube to the surface of the water. The air pressure variations caused by water depth changes activate the pressure switch thus controlling the pump. A pressure tank of nitrogen gas may be used instead of an air compressor. Nitrogen gas is often used because it is cheap, readily available, inert, safe, dry, and about the same weight as air in the atmosphere. If the bubble rate is kept low a 116 cubic foot cylinder will last about 1 year. The air line should be of small diameter. Almost any material can be used for the air line, including standard water pipe, copper tubing, plastic tubing, or hose. Small leaks in the line can be compensated for and will not interfere with proper operation. The switch can be remote from the bubbler tube. Water level adjustment is done at the switch. The diaphragm type of sensing device consists of a neoprene diaphragm placed across the opening of an air chamber submerged in water. See figure 7-13. An air line, called a capillary tube, extends from the air chamber to a pressure activated switch. An increase of water depth over the diaphragm causes the diaphragm to move into the air chamber, which causes the air pressure within the air chamber to increase. The increase of air pressure is transmitted to the pressure activated switch, which in turn starts the pump. There are no moving parts in this system, no air compressor or gas cylinder is needed, and the switch can be located at a point remote from the diaphragm. The smallest air leak will disable the system. Water level settings may be adjusted at the switch.

A bell type of system resembles an inverted water glass submerged in the water, with the air-water interface acting as the diaphragm. See figure 7-13. In all other ways the bell type system is the same as the diaphragm type system.

In larger sized pumping units and where internal combustion engines are used, manual starting with automatic shutoff will often prove to be advantageous. The operator must be present at each start in order to service and check equipment at beginning of operation. This should assure that equipment is in good operating condition and is serviced and checked for possible damage to pumps, motors, or engines not protected by safety devices.

Safety controls

A low level cutoff must be installed in each suction bay to prevent the possibility of the pump operating with an insufficient depth of water over the suction bell. Low water can occur if the pump control malfunctions or if trash plugs the trash rack. A time delay relay should be included in the low level cutoff circuit so that the pump must remain off for some given time. This time delay will prevent the short cycling which would occur with a plugged trash rack. In a multiple pump installation time delay relays should be included in each starting circuit to prevent simultaneous starting of electric motors after a power failure.

When pressure lubrication is used on the pump, motor, or gearbox a safety switch should be installed which will stop the motor if low lubrication pressure occurs.

Overload protection must be provided for all motors. A well designed overload relay will protect the motor against overheating from any cause, including short cycling, overloading, locked rotor, single phasing, phase reversal, and unbalanced phase voltages. Short circuit protection must also be installed. Protection against lightning should also be installed.

Experience has shown that all engines should be provided with safety controls even if not planned for automatic operation. A governor should be installed to regulate engine speeds. Cutoff devices should be provided to stop the engine if low oil pressure develops, excessive engine temperature develops, or if excessive speeds develop due to governor failure. Such automatic and manual engine operating devices should be supplied by the engine manufacturers.

Recorders and signaling devices

Automatically operated installations should have a signal device, such as a light, to show when pumps are operating. In a large installation with automatic operating controls a signal panel is desirable to show which safety control device stopped the pumps. This would save a great deal of time in locating the trouble. A recording indicator of running time of each pump could pinpoint short cycling, time of failure, and show which pumps are running at time of failure. Also, the record of running time would be useful in scheduling maintenance.

Sump dimensions

Sumps or suction bays for drainage pumping plants are contained in structures. Sumps may range from large open ended pits for handling large quantities of surface and subsurface water to small open or closed pits handling only the effluent from subsurface drains. The sump entrance must be large enough to pass the design discharge to the pumps without appreciable restriction. Maximum water level will be the optimum (design) stage in the sump. Level of the operating floor containing power units should be at high enough elevation above the optimum stage that inundation from all but extreme floods will not occur should pumps not be operating. The floor level also should be high enough above operating stage to provide protection against surge as might develop from sudden stoppage of the pumps and to provide clearance required for proper location and installation of suction and discharge pipes.

Minimum horizontal sump area will be that necessary for spacing pumps, installing suction and discharge lines, and controlling flow within the sump at velocities that will not cause appreciable turbulence or cross currents. The opening from the forebay storage area or channel should be aligned to avoid a change in direction of flow and be of sufficient size to keep the entrance velocity below 3 feet per second. The shape and dimensions of the sump should be such as to supply an even distribution of flow to the suction intake of pumps. This will avoid formation of large vortexes or cause low submergence that would permit entry of air into the pumps. Figures 7-14, 7-15, and 7-16 provide layouts, spacings and dimensions of sump and pumps for design of drainage pumping facilities. These are based on analysis of many installations but may require some modification to meet manufacturer's recommendations for the particular pump used.

SUMP DIMENSIONS VERSUS FLOW

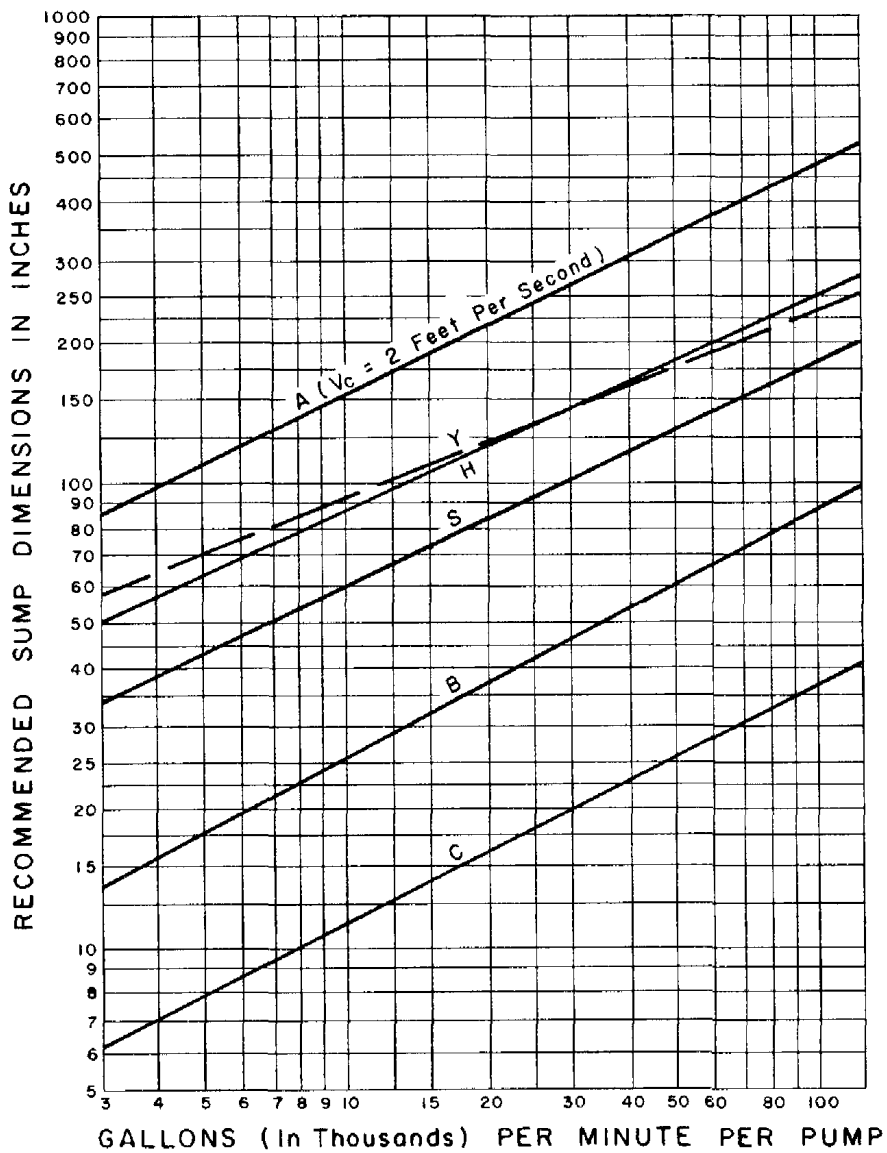

REFERENCE: Reprinted from
Hydraulic Institute Standards
12th Edition. Copyright 1969 by the
Hydraulic Institute, 122 East 42nd St.
New York, New York 10017

U.S. DEPARTMENT OF AGRICULTURE
SOIL CONSERVATION SERVICE
ENGINEERING DIVISION - DRAINAGE SECTION

STANDARD DWG. NO.
ES - **730**
SHEET 1 Of 3
DATE February 1971

Figure 7-14, Sump dimensions versus flow

SUMP DIMENSIONS VERSUS FLOW MULTIPLE SUMP

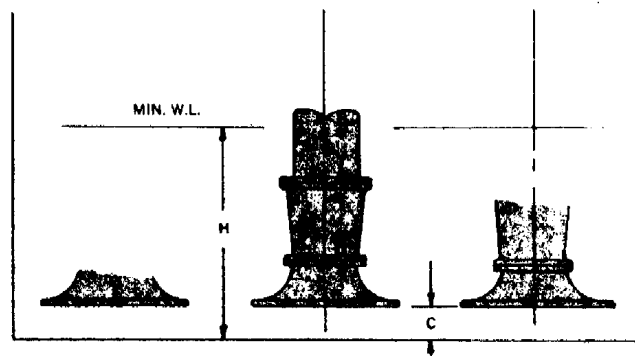
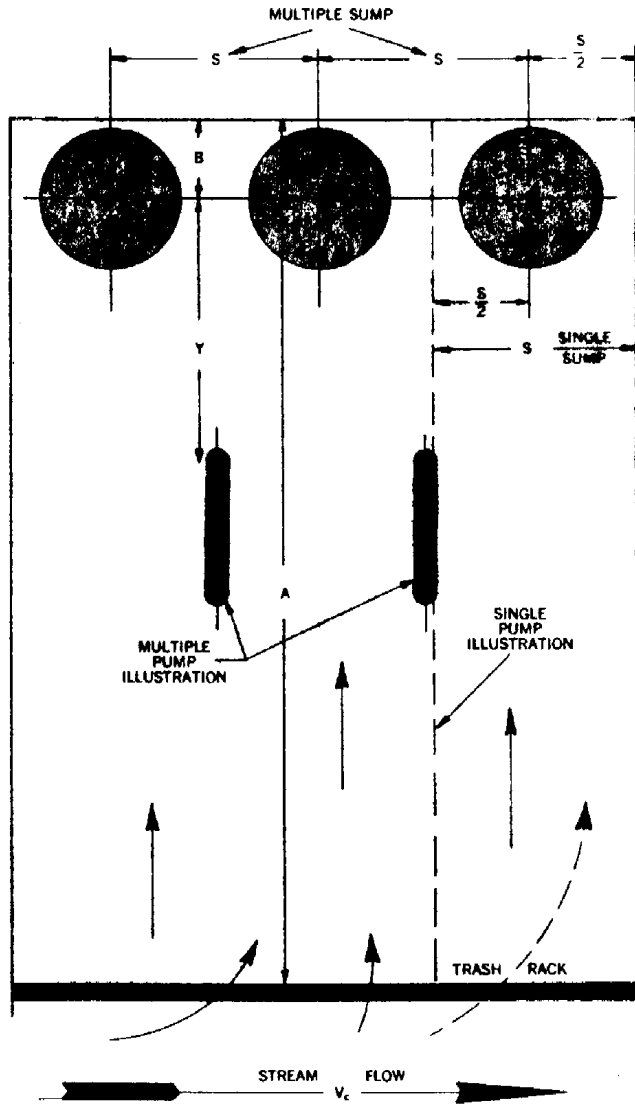

REFERENCE: Reprinted from
Hydraulic Institute Standards
12th Edition. Copyright 1969 by the
Hydraulic Institute, 122 East 42nd St.
New York, New York 10017

U. S. DEPARTMENT OF AGRICULTURE
SOIL CONSERVATION SERVICE
ENGINEERING DIVISION - DRAINAGE SECTION

STANDARD DWG. NO.
ES - **730**
SHEET 2 Of 3
DATE February 1971

Figure 7-15, Sump dimensions and pump arrangement

SUMP DIMENSIONS VERSUS FLOW MULTIPLE PUMP PITS

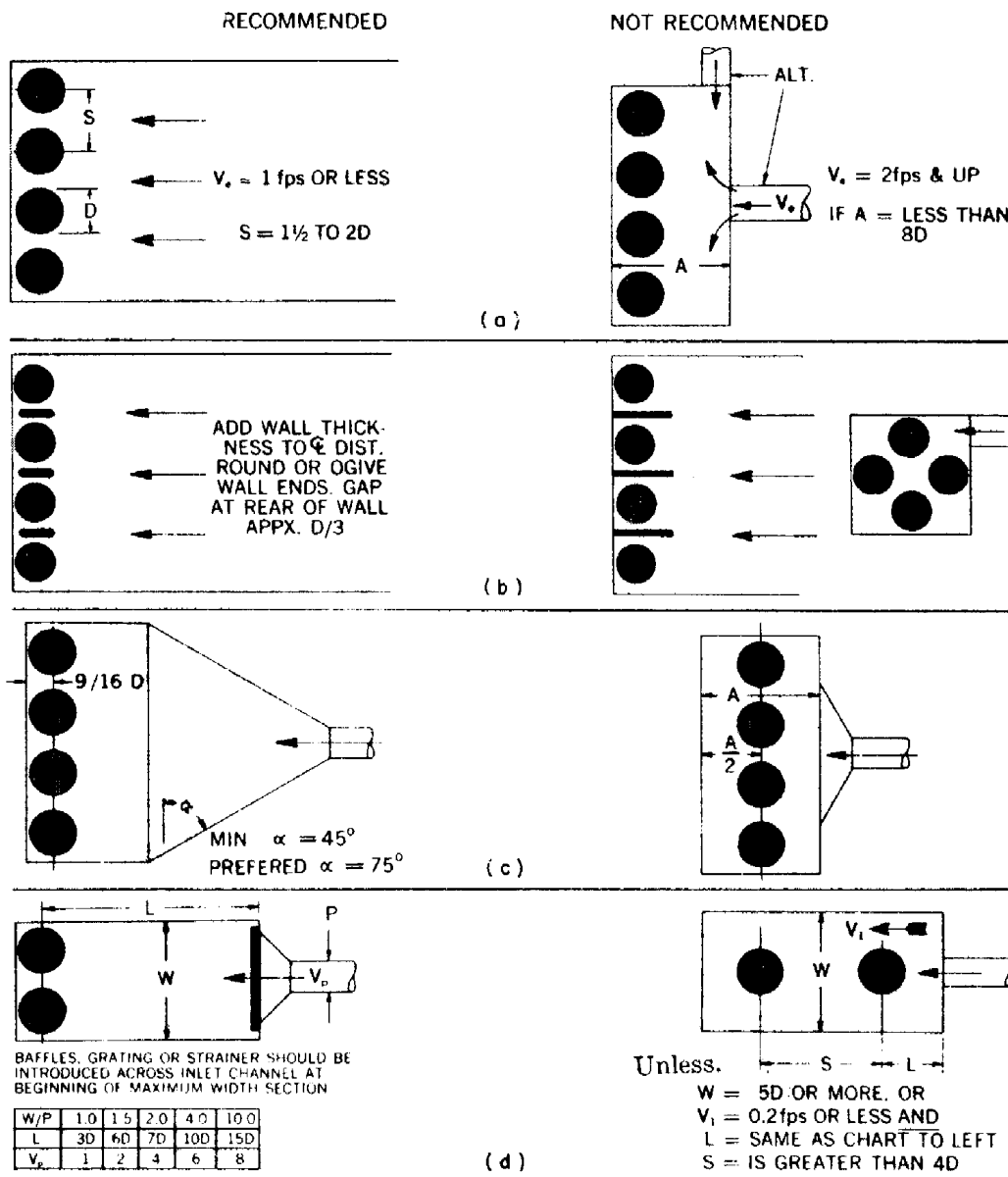

The Dimension "D" is generally the diameter of the suction bell measured at the inlet. This dimension may vary depending upon pump design. Refer to the pump manufacturer for specific dimensions.

REFERENCE: Reprinted from Hydraulic Institute Standards 12th Edition. Copyright 1969 by the Hydraulic Institute, 122 East 42nd St. New York, New York 10017

U.S. DEPARTMENT OF AGRICULTURE
SOIL CONSERVATION SERVICE
ENGINEERING DIVISION - DRAINAGE SECTION

STANDARD DWG. NO.
ES - **730**
SHEET **3** Of **3**
DATE **February 1971**

Figure 7-16, Sump dimensions and pump arrangement

Recommendations in figures 7-14 and 7-15 apply to both single and multiple pump installations. Dimension C could be slightly smaller or larger depending upon the manufacturer's recommendation. Dimension B is a suggested maximum which may be less depending upon suction bell or bowl diameters used by the manufacturer. The edge of bell should be as close as possible to the sump backwall but may be determined by required motor spacing on the floor or discharge pipe spacing in the sump. If this spacing is excessive, a false backwall should be used. Dimension S is a minimum for a single pump installation but can be increased. Dimension H is a minimum based on normal low water level at the suction bell, taking into consideration friction losses of a suction screen. This dimension can be less without damage to the pump if occurrence is momentary or infrequent. H represents the physical height of water level above the bottom of the suction inlet and is not submergence which normally is considered as H minus C. Dimensions Y and A are minimums. If a screen is not used at the suction bell, A should be larger. Screen widths should not be less than S.

Figure 7-16 illustrates additional considerations for multiple pump installations. Velocity should be low and flow simultaneous to all units in a straight line as shown in figure 7-16 (a). A number of pumps in the same sump operate best without separating sidewalls unless all pumps are always operating at the same time. If sidewalls must be used for structural purposes and pumps are operated intermittently, flow space should be left behind each wall as shown in figure 7-16 (b). Changes in size of inlet pipe or channel should be gradual as illustrated in figure 7-16 (c). The taper should be at an angle of 45 degrees or more and pumps located close to backwall to prevent large vortex areas. Pumps in line are not recommended unless ratio of pit to pump size is quite large and pumps are widely separated longitudinally. If pit velocity can be kept below a foot per second, an abrupt change from inlet pipe to pit can be accommodated when lengths exceed values shown in figure 7-16 (d).

Sump capacity

Total forebay and sump storage for the pump should be sufficient to prevent excessive starting and stopping of the pumps. Such storage is the volume of runoff and ground water in forebay and sump that will be removed between the start and stop levels in the sump. In large pumped areas most of the available storage must be obtained outside the sump from natural areas in or beyond the forebay. For comparatively small areas up to a square mile, available storage may be increased by ditch enlargement in the forebay area. For small acreages where only subsurface drainage will be pumped, available storage may be limited to the constructed sump.

Storage requirements depend upon pumping rate and frequency of cycling. When the inflow rate is less than the pumping rate, cycling will occur. For manually operated pumps the number of stops and starts should not exceed two to three cycles per day in consideration of operator convenience. For automatically operated pumps the number of cycles per unit of time should not exceed the manufacturer's rating. Based on University of Minnesota Studies by Larson and Manbeck (11) on small sumps where cycling is frequent, efficient operation can be obtained for electrical motor driven pumps with 10 to 15 cycles per hour.

Time of one pumping cycle equals the time it takes to empty the storage in the sump and the inflow during the emptying process, plus the time it takes for inflow to refill the sump after the pump has stopped. This is expressed in the following equation.

$$\frac{60}{n} = \frac{7.5 S}{Q_p - Q_i} + \frac{7.5 S}{Q_i} \quad (\text{Eq. 7-9})$$

where

n = number of cycles per hour

S = storage volume in cubic feet

Q_p = pumping rate in gallons per minute

Q_i = inflow rate in gallons per minute

7.5 = conversion factor for gallons to cubic feet

At maximum storage

$$Q_i = \frac{Q_p}{2}$$

$$\text{and } S = \frac{2Q_p}{n}$$

Generally sump sizes should be such as to provide at least 1-foot depth in open pits and 2-foot depths in closed pits between starting and stopping levels of the pump.

Closed sumps may be constructed of concrete, concrete block, silo staves, corrugated metal or metal tanks. Rectangular shapes are recommended, although the circular shape is satisfactory for small systems and is more economically built. At higher velocities some rotation and turbulence can develop in the circular sump. The sump should be checked for uplift. Most serious conditions occur when the sump is pumped down and the surrounding soil is saturated. Structural design and construction of large sumps must be based on site conditions on an individual job basis and is not covered in this text.

Stop logs

Stop log gates should be provided for the sump openings so the sump can be dewatered for pump repairs or cleaning. Slots should be made in the end walls of the opening or passageway walls for placing the stop logs. Stop logs may be seasoned timber or wood faced I-beams with strength to withstand imposed fluid pressures and treated against rot, insect damage, and corrosion. Provision should be made for convenient handling and storage when not in use.

Trash racks

Trash racks should be provided to screen out trash and debris from surface flows entering sumps. Strainers or screens mounted on the bell or suction flange should be avoided since they tend to clog and are hard to clean. The trash rack should be located across the entrance of the sump and inclined toward the structure in such manner that flow moves evenly through the rack and collecting trash and debris tends to float up toward the water surface where it can be easily removed by rakes. Bar screens should be used in which the clear space between bars is within the range of 1 1/2 to 3 inches. The total clear flow area of the rack should be sufficient to keep the velocity through the rack under 2.5 feet per second. Trash racks should be located

outside of the pumping plant structures to facilitate removal of trash. Racks should be removable or hinged so that if it becomes necessary they can be raised above the floor and blocked open when pumps are not in operation. In most cases raking will be done by hand and a suitable platform with guardrail should be provided for safety in collecting and disposing of the trash and debris. A log boom or float, anchored upstream from the entrance, may be needed where timber or large floating debris is a problem.

Discharge pipes

Discharge pipes usually will be located under, through, or over a protecting structure, which is usually an earthen dike. Steel pipes, adequately protected from corrosion, are best suited and almost universally used for this purpose. Flexible couplings should be provided where the pipe passes through the sump or walls of the pump plant structure and where sharp bends are placed in the line. Thrust rods must be installed at the elbows of a vertical pump to prevent movement of the pump. Flexible couplings allow for structural settlement and expansion or contraction of the pipe. Sharp bends in the line should be avoided. Use of a separate pipe for each pump is desirable, with the pipe connected directly to the pump discharge flange. Thrust blocks may also be required at changes of alignment.

Discharge pipes may be installed through or over the wall or embankment. Pipes through the structure are advantageous in that sharp bends can be avoided but are subject to back pressure and possible backflow when the pumps are not in operation. When pipes are installed below the high water level on the discharge side of a dike, special precautions must be taken to prevent piping along the conduit. Flap gates of good quality must be provided to protect against backflow. A hydraulically cushioned flap gate should be used if the flap gate is within a few feet of the pump or the water depth is several feet above the flap gate. Gates should be so located that silt and debris will not accumulate, particularly during periods when the pumps are not in operation, and thus obstruct gate operation. Pipes ordinarily are supported by the dike embankment with projections on the discharge end, either in a headwall structure or on pile bents which should also support directly the weight of the flap gates. Unless a suitable headwall structure is used, the pipe should project a sufficient distance beyond the dike face to provide protection from erosion or eddy currents. Where amount of discharge is large, riprap protection of the embankment is necessary. All conduits through dikes below the maximum high waterline must be connected to the pump with a flexible coupling and provided with anti-seep collars designed to increase the seep line distance along the conduit by at least 15 percent.

Pipe backflow can be eliminated by placing the conduit over the top of the wall or dike. This is particularly applicable in the case of small pumping units or where pumping at higher heads is of such short duration that operating costs are not affected materially. Much of the pumping head can be recovered if such lines over the dike are extended and lowered on the water-side of the embankment so as to operate as a siphon. This is particularly advantageous where extensive pumping is done at high heads. Flap gates must be provided to protect against stoppage of the pump and backflow caused by reverse siphoning. Siphon breakers should be installed in the pipe to prevent backflow.

An air vent in the high point of discharge pipes is desirable in preventing excess back pressure when starting pumps. Mounding earth over pipe on dikes is desirable as protection against pipe displacement and erosion of the dike

surface when high flood stages occur. Such mounding also permits establishment of crossings for maintenance equipment and vehicular traffic.

Housing

Housing is usually needed for pumps, prime movers, and operating controls, to protect them against weather, moisture, and vandalism, and to provide suitable working area for manual operation, maintenance, and repair work. In some situations where sealed motors, enclosed engine and transmission units, etc. are used, such housing may be omitted. In any case, storage should be provided for tools, supplies, operation and maintenance manuals and records.

Housing usually consists of a superstructure or building over the operating floor above the sump. The structure should be fire resistant and conform to local building codes when these exist. Adequate ventilation is essential for internal combustion engines. In the case of large pump units sufficient floor clearance and special openings, such as doors or removable panels in sidewalls and roof, should be provided. Normally, gantry cranes are installed as permanent equipment for large pumping units. For small units hoisting equipment may be omitted where motor cranes can be obtained when needed for this purpose.

When engine-driven fan cooling systems are used, necessary ventilation of the building is provided through automatically controlled louvers. Air intake louvers should be installed with greater capacity than exhaust louvers to protect against reduction of air pressure within the structure below atmospheric pressure. Where feasible, radiators should be mounted so heat can be removed from the building directly through the wall or through exhaust ducts.

Particular attention should be given to protection of wiring and control equipment against corrosion from moisture and fumes. Wiring should be enclosed in corrosion-resistant conduits and control boxes.

Equipment such as switches, floats, and tapes should be of corrosion-resistant metal. Floats should be encased in wells with an opening near the bottom of the sump so as to minimize effect of surges. Temperature and moisture in the well may be controlled by means of an electric bulb.

When fuel storage tanks are used, National Board of Fire Underwriters and local jurisdictional codes should be followed in the installation and supply of the tanks. Tank size should be determined on the basis of storage required for maximum rates of operation over the anticipated pumping period and consideration of access of the source of supply to the pumping facility. Storage for a 3-day operating supply should be the minimum provided, and this should be increased to meet adverse delivery and operating conditions.

Pumping installations should be provided with fences and railing to protect operators and the public from hazards such as pits and dropoffs. Protection of operators from moving belts and drive shafts, engine exhaust pipes, and electric currents should be provided through use of guards, covers, and warning signs. Gates and doors with locks should be provided to prevent unauthorized operation and vandalism.

Since pumping plants are usually unmanned for a large part of the time and are often remote from habitations and roads, use of exterior lights and sound warning systems at the structure or remote monitoring station, activated by sump floats or the pump starting system, are a desirable feature in assuring timely attention of the responsible operator.

Field Tests of Drainage Pumping Plants

Field tests of new drainage pumping plants check performance of pumping units against design and specifications. Tests of operating plants are desirable at intervals to determine operating efficiencies.

The discharge of water in pipes may be measured with a probable accuracy of 5 percent by use of Tulane pitot tubes, discussed in the following section.

Procedure for field tests

Surveys and gages

Temporary staff gages in the suction and discharge bays should be established using assumed or sea level datum as zero on gages. However, legible gages which exist may be used with elevations checked to nearest 0.01 foot.

Elevations on the same datum as the staff gages should be obtained of the following:

1. Floor of suction bay.
2. Entrance lip of suction pipe.
3. Centerline of pump, motor, and engine shafts.
4. Elevations of each pump, engines, motors, suction and discharge pipes so that an accurate plan and profile may be drawn of each pumping unit. Manufacturers' catalogs may be consulted to obtain dimensions.
5. Elevation to nearest 0.01 foot of the centerline of each hole tapped in suction, discharge pipe, or pump.
6. Diameter of pipe to nearest 0.001 foot at each hole tapped in suction or discharge pipe or pump, including the hole where pitot tube or piezometer is inserted.
7. Diameters and lengths to nearest 0.01 foot of tangents and bends of the suction and discharge pipes.

Total head on pump

The total head on the pump is determined by measuring the discharge head close to the discharge flange of the pump, the suction head close to the entrance of the pump and correcting for differences in velocity head and elevation of points of measuring.

The total head on the pump is equal to the total energy in the water at the discharge flange minus the total energy at the suction flange of the pump. It is expressed by Equation 7-3 where total head equals static lift plus the losses in the suction pipe, the losses in the discharge pipe, and the velocity head. (See section on "Total dynamic head" under "Pumping Plant Design.")

Where the pump is submerged it may not be feasible to measure the suction pressure head, h_s . In such cases the total head may need to be estimated by measuring the discharge pressure head, h_d , and estimating the suction pressure head by taking into account the estimated entrance loss of the suction

pipe and the friction losses in the suction pipe. King and Brater's Handbook of Hydraulics (9) and NEH Section 5, Hydraulics (8) explains how these losses may be estimated.

Measurement of h_d and h_s in the field are accomplished by the following procedures:

Tap, ream and thread a hole in discharge pipe to take a standard 1/4 inch pipe nipple, which should be about 4 inches long. (See figure 7-17.) One hole should be located at centerline of pipe from 4 to 18 inches from the pump flange. A valve, rubber hose and glass tube are attached as shown in the figure. If flow is unusually turbulent at this point as indicated by the preliminary tests, it may be important to drill additional holes at top and both sides or on 45° diameters to obtain an average reading around pipe.

A standard globe valve screwed on the pipe is opened when readings of the pressure head are taken and closed after readings are made.

At least one more nipple is required to connect with a rubber hose which will fit over a piece of glass tubing. Glass tubing having an internal diameter of 1/8 to 3/16 inch is recommended. The rubber hose should fit over the glass tube. A 1/4 to 1/8 inch reducer between the valve and rubber hose permits one end of the hose to be fitted over a short 1/8 inch standard nipple.

Discharge measurements

In making field tests of drainage pumps a measurement of the discharge should be obtained within the required accuracy. Measurements may be accomplished by a Tulane pitot tube within 5 percent accuracy.

In order to obtain the most accurate results, the following test conditions are desirable:

1. A straight length of pipe in which uniform flow conditions exist. Tangents should be at least five times the diameter.
2. The pipe running full of water during test.
3. Pipes on horizontal tangent but sloping pipe may be used.
4. Approximate measurements by current meter which are adequate for determining operating efficiency of the pumping unit. Such measurements probably provide discharge readings within 10 percent accuracy. This may be used as a basis to determine if the efficiency is unusually low and whether the expense of the pitot tube measurements is justified.

In many farm pumping plants, a sufficient length of discharge pipe is not available to obtain accurate pitot tube measurements, the pipe does not run full of water, or the pipe is inaccessible. Under such conditions, measurements by weir, orifice, flume (Parshall), or channel water measuring device should be considered. Measurements of discharge by these methods are described in hydraulic texts and will not be discussed herein.

Discharge measurements with Tulane pitot tubes

After the point of measurement is selected as described above, the following procedure is used in making a discharge rating.

DRAINAGE PUMPING PLANT FIELD TESTS SUCTION AND DISCHARGE GAGES

Measure height (h_d) of water in feet where pipe is under pressure.

Where discharge is under vacuum, set up mercury gage as shown on suction side of pump.

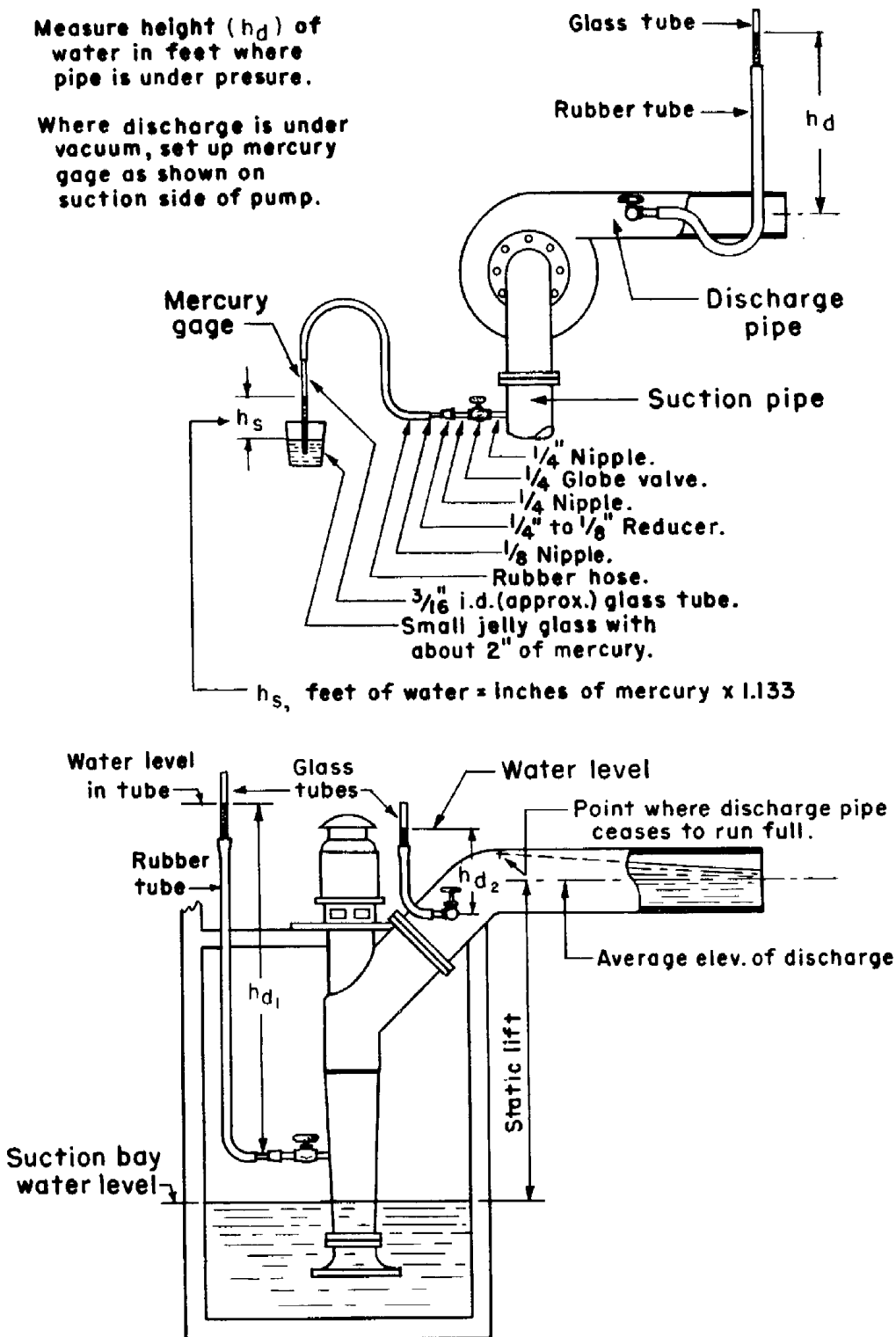

REFERENCE
U. S. D. A. Technical Bulletin
No. 1008

U. S. DEPARTMENT OF AGRICULTURE
SOIL CONSERVATION SERVICE
ENGINEERING DIVISION - DRAINAGE SECTION

STANDARD DWG. NO.
ES - 731
SHEET 1 Of 1
DATE February 1971

Figure 7-17, Suction and discharge gages for pumping plant field tests

1. Drill vertical hole through discharge pipe at point selected. The hole should be drilled and threaded so that the stuffing box of the pitot tube may be screwed in. (See figure 7-18.)
2. Assemble and center the pitot tube in the pipe by measuring up from the bottom of the pipe. The stuffing box usually projects slightly into the pipe at the upper side and this prevents centering the pitot tube by measuring from the top of the pipe. Drill a hole in a 1- by 6-inch board as shown in figure 7-18 so that the point of the pitot tube is at the center of the pipe when the centerline hole of the board supports the handle.
3. Drill five additional holes above the centerline hole at distances as follows:
 - a. 0.949 r
 - b. 0.837 r
 - c. 0.707 r
 - d. 0.548 r
 - e. 0.316 r

Establish a similar set of holes below the centerline. These holes are set so that 5 and 6 are on the circumference of 0.1 the pipe area. Points 4 and 7 are on the circumference of 0.3 the area. Points 3 and 8, 0.5 area; 2 and 9, 0.7 area; and 1 and 10, 0.9 area.

4. Raise water from discharge pipe so that upper and lower water levels may be read on the gage. This is accomplished by a valve at the end of the pitot tube gage. A vacuum pump is required to draw water into the glass tubes if pipe is under vacuum.
5. Starting at top of pipe take velocity head readings at holes 1 to 10, inclusive, moving the pitot tube down the pipe. Take a second reading from each hole, starting at the bottom and moving the tube up.
6. Centerline readings are made but are not averaged in.
7. Compute average velocity in pipe by averaging all velocity head readings except the center reading and substitute in the formula

$$v = \sqrt{2gh}$$

Pump efficiency

Pump efficiency is computed by the following formula

$$e = \frac{\text{GPM} \times H_t}{\text{BHP} \times 3960}$$

where

e = pump efficiency

GPM = gallons per minute

H_t = total head on pump

BHP = brake horsepower input into pump shaft

TULANE PITOT TUBE AND TEMPLATE FOR MEASURING WATER VELOCITY IN PIPES

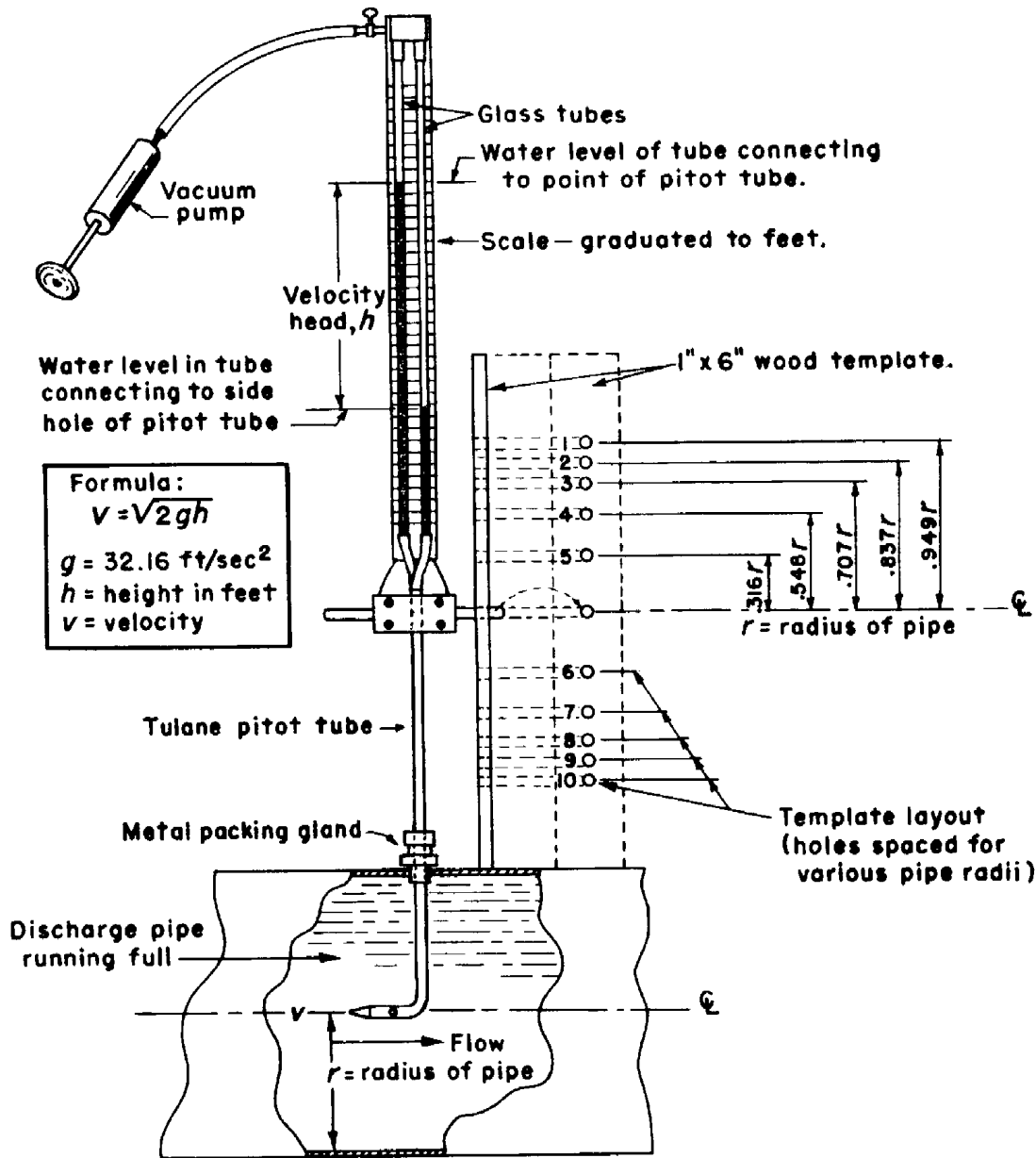

REFERENCE
 U. S. D. A. Technical Bulletin
 No. 1008

U. S. DEPARTMENT OF AGRICULTURE
 SOIL CONSERVATION SERVICE
 ENGINEERING DIVISION - DRAINAGE SECTION

STANDARD DWG. NO.
 ES - **732**
 SHEET 1 OF 1
 DATE February 1971

Figure 7-18, Tulane pitot tube and template for measuring water velocity in pipes

Operation and Maintenance

Operation and maintenance of a drainage pumping facility is more often in the hands of untrained people. Therefore, equipment should be as reliable, simple in construction and operation, and require the least amount of maintenance as can be obtained economically. Likewise, simple and explicit instructions on operation and maintenance should be made available to those responsible.

Operators should know the instructions on pumps, motors, engines, and control devices and should follow the best operating procedures. Pumps depending upon water lubrication should not operate empty. Where pumps depend upon priming, complete filling of water should be accomplished so pockets of air will not collect in the casing around the shaft and thus reduce discharge. Where prime movers are used such as engines that permit substantial variation in speed, pump operation should be regulated to provide the most efficient speed as determined from tests or characteristic curves. Where several units are included in the facility, the most efficient unit or combination of units should be used for most of the pumping. Each unit should be operated periodically to assure reliable operation when needed. Equipment should be kept in good repair. Equipment, plant, and grounds should be kept clean and orderly to minimize the hazard of fire, assure ready access and efficient operation and prevent accidents.

Thorough inspection of the facility should be made periodically during operation, at least monthly during periods of nonoperation, and just prior to the expected time of continuous or peak usage. Inspection; cleanup and oiling of engines, motors and pumps; flushing of sumps; and replenishing of fuel and lubricants should follow immediately after a major operation in readiness for the next period of use.

Occasional tests are desirable, particularly on the larger facilities, in order to detect poor operating efficiency as may result from wear and other less obvious causes that indicate need for such timely repairs as replacement of worn impellers, etc.

Inspections should indicate the condition of the plant forebay and discharge bay areas, and arrangements should be made for disposal of debris, drift, and trash accumulations that would interfere with gate operation and trash racks. The inspection should disclose any erosion, leaks, and displacement of riprap protection at foundations that should be repaired. At least seasonally, hinges and seats of flap gates and slide controls of valve gates should be lubricated and trial operated. Also, stop logs and other emergency equipment should be checked for adequacy.

Monthly inspections should include test runs of pumps and power equipment. Power units such as the gasoline engine should be operated to check battery units and prevent accumulation of condensation and sludge in fuel lines and carburetors. Automatic controls, particularly the solenoid type, are quite susceptible to deterioration after periods of disuse and should be checked regularly. These checks on their condition are important since workmen skilled in their repair and maintenance are not always readily available at times of emergency.

An operations and maintenance manual should be prepared which will include repair manuals, shop drawings, wiring diagrams, plumbing diagrams, periodic (as monthly) inspection sheets, directions for operation and "troubleshooting."

The manual should contain methods for testing operation of pumps, controls, and safety switches.

Accurate operation and cost records are necessary for adequate supervision and economical operation of a pumping plant. Preventive maintenance, proven least expensive in construction and industry, requires adequate records and maintenance schedules.

References

- (1) HYDRAULIC INSTITUTE STANDARDS, 12th Edition
1969. Hydraulic Institute, New York, N.Y.
- (2) UNITED STATES DEPARTMENT OF AGRICULTURE, SOIL CONSERVATION SERVICE
1971. National Engineering Handbook, Section 4, Hydrology.
- (3) SUTTON, JOHN G.
1950. Design and Operation of Drainage Pumping Plants, U.S. Dept. Agr.,
Soil Conservation Service Technical Bulletin 1008, U.S.
Government Printing Office.
- (4) UNITED STATES DEPARTMENT OF COMMERCE
1961. Weather Bureau Technical Paper 40, U.S. Government Printing
Office.
- (5) UNITED STATES DEPARTMENT OF COMMERCE
1964. Weather Bureau Technical Paper 49, U.S. Government Printing
Office.
- (6) ADAMS, H. W.
1957. Pumping Requirements for Levied Agricultural Areas, ASCE
Journal of Irrigation and Drainage Division, Vol. 83,
No. IR1, New York, N.Y.
- (7) UNITED STATES DEPARTMENT OF AGRICULTURE, SOIL CONSERVATION SERVICE
1959. National Engineering Handbook, Section 15, Irrigation,
Chapter 8.
- (8) UNITED STATES DEPARTMENT OF AGRICULTURE, SOIL CONSERVATION SERVICE
1951. National Engineering Handbook, Section 5, Hydraulics.
- (9) KING, H. W. and BRATER, E. F.
1963. Handbook of Hydraulics, 5th Edition, McGraw Hill, New York, N.Y.
- (10) W. Q. O'NEALL CO.
1936. Handbook of Water Control, Chicago, Illinois.
- (11) LARSON, C. L. and MANBECK, D. M.
1961. Factors in Drainage Pumping Efficiency, Agr. Eng. Vol. 42.
American Society of Agricultural Engineers, St. Joseph, Michigan.

APPENDIX A

Determining Pumping Plant Capacity Based on Hydrologic and Economic FactorsExample

A watershed project is proposed for the Upper Maple River in Gratiot, Clinton, and Shiawassee Counties, Michigan to provide flood protection and improved drainage necessary for the production of navy bean and sugar beet crops. Engineering studies* show (a) that water retarding structures will provide only a minor part of the needed flood protection, (b) that extensive diking and channel improvements are necessary, and (c) that several low laying areas behind dikes must be pumped at high river stages in order to avoid extensive (economically infeasible) channel enlargement and deepening downstream. One of the pumped areas would be located within Hamilton and Elba Townships in Gratiot County. (See figure 7A-1.) The dikes (extending along the east bank of Bear Creek from a reach west of the town of Ashley to a gated outlet into the Maple River and thence along the north bank of Maple River to a reach west of the town of Bannister) would enclose 24 square miles of land that at high flows in Maple River would be drained by pumps. The pumps are to be located near the junction of Bear Creek and Maple River. The pumping rate is to be determined within an acceptable cost-benefit ratio on the basis of an evaluation of various pumping rates and their effect upon the flooding and drainage impairment of the area.**

Rainfall determination

Soil conditions and land use under project objectives are estimated. Amounts of rainfall for various frequencies of occurrence ranging from 3 hours to 10 days' duration are obtained from U.S. Weather Bureau Publications TP 40 (4) and TP 49 (5). Values are plotted as shown in figure 7A-2.

Runoff determination

The amounts of runoff for various durations and frequencies of occurrence are determined as shown in table 7A-1. These values are obtained from figure 7A-2, soil cover complex number 77 selected from table 9.1 NEH Section 4 - Hydrology, and Standard Drawing ES 1001 (figure 10.1 NEH section 4 - Hydrology)

Watershed hydrograph bases (Chapter 16 - NEH Section 4 - Hydrology) are determined using a computed time of concentration (T_c) of 7.23 hours. The time of hydrograph peak (T_p) is based on equation

$$T_p = \frac{D}{2} + 0.6 T_c$$

where D is the storm duration and the time of hydrograph base (T_b) is determined from the equation

$$T_b = 2.67 T_p$$

* SCS Watershed Work Plan Investigations by Huson A. Amsterberg and Russel H. Bauerle, Hydraulic Engineers, and John L. Okay, Agricultural Economist.

** Pumping for Agricultural Areas by Guy B. Fasken, SCS, Lincoln, Nebraska, and Pumping Requirements for Levied Agricultural Areas by H. W. Adams (6).

PROJECT LOCATION MAP
UPPER MAPLE RIVER WATERSHED

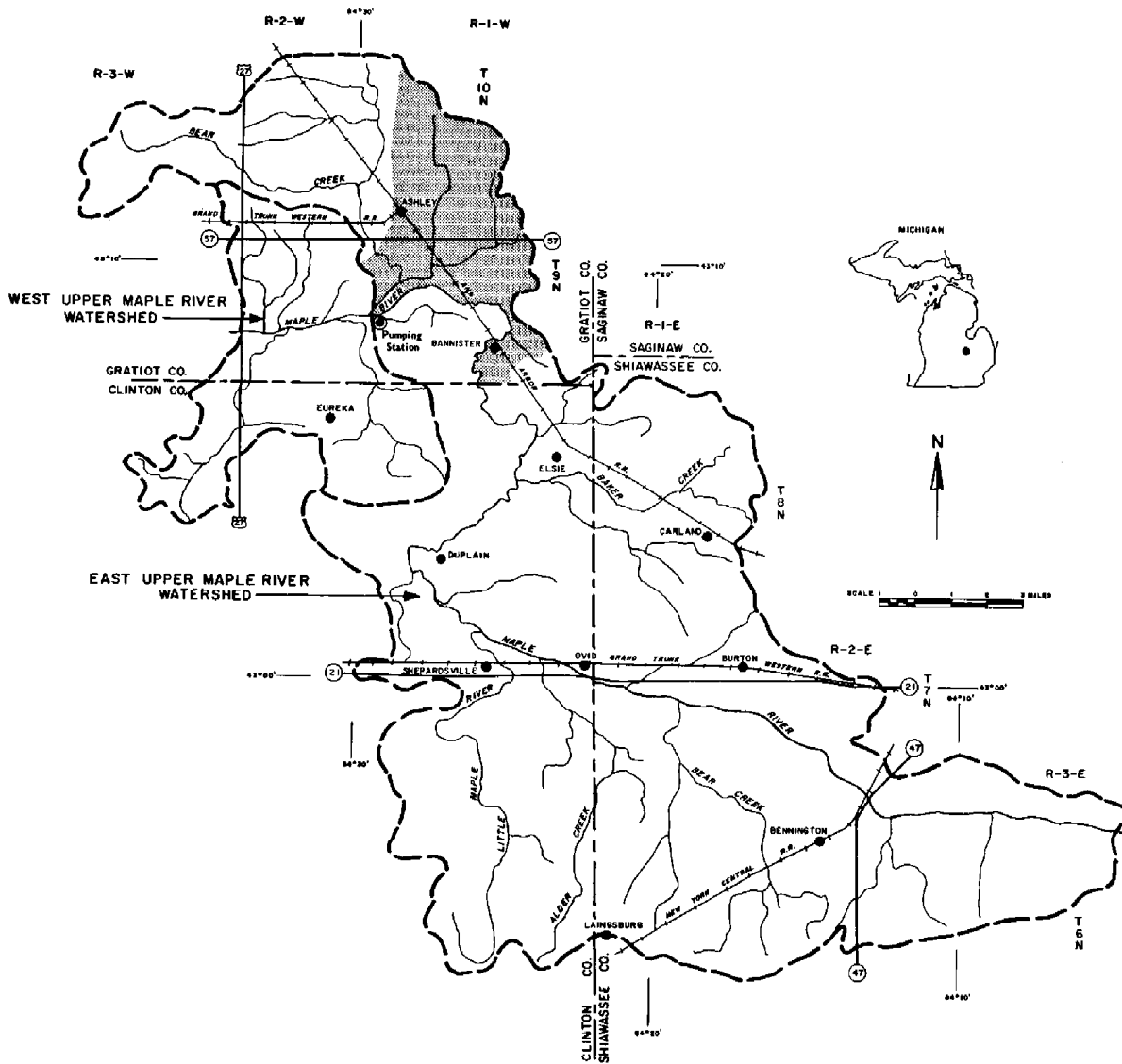

Figure 7A-1, Pumping plant location

Table 7A-1, Rainfall - runoff duration - frequency

| Rainfall Duration Days | 1-Year Frequency | | 2-Year Frequency | | 5-Year Frequency | | 10-Year Frequency | | 25-Year Frequency | |
|------------------------------|--------------------|--------|--------------------|--------|--------------------|--------|--------------------|--------|--------------------|--------|
| | Rainfall Inches | Runoff | Rainfall Inches | Runoff | Rainfall Inches | Runoff | Rainfall Inches | Runoff | Rainfall Inches | Runoff |
| 0.125 | 1.30 | 0.14 | 1.57 | 0.25 | 1.97 | 0.43 | 2.28 | 0.61 | 2.57 | 0.78 |
| 0.250 | 1.54 | 0.24 | 1.78 | 0.33 | 2.28 | 0.61 | 2.62 | 0.82 | 2.97 | 0.98 |
| 0.500 | 1.77 | 0.33 | 2.05 | 0.48 | 2.65 | 0.83 | 3.05 | 1.11 | 3.42 | 1.37 |
| 1.000 | 2.09 | 0.50 | 2.40 | 0.68 | 3.04 | 1.10 | 3.50 | 1.43 | 3.95 | 1.77 |
| 2.000 | 2.43 | 0.70 | 2.75 | 0.89 | 3.46 | 1.41 | 4.00 | 1.81 | 4.50 | 2.21 |
| 4.000 | 2.84 | 0.96 | 3.20 | 1.21 | 4.00 | 1.81 | 4.60 | 2.29 | 5.20 | 2.79 |
| 7.000 | 3.21 | 1.22 | 3.56 | 1.47 | 4.50 | 2.21 | 5.20 | 2.79 | 5.80 | 3.30 |
| 10.000 | 3.48 | 1.41 | 3.88 | 1.71 | 4.80 | 2.45 | 5.60 | 3.13 | 6.30 | 3.74 |

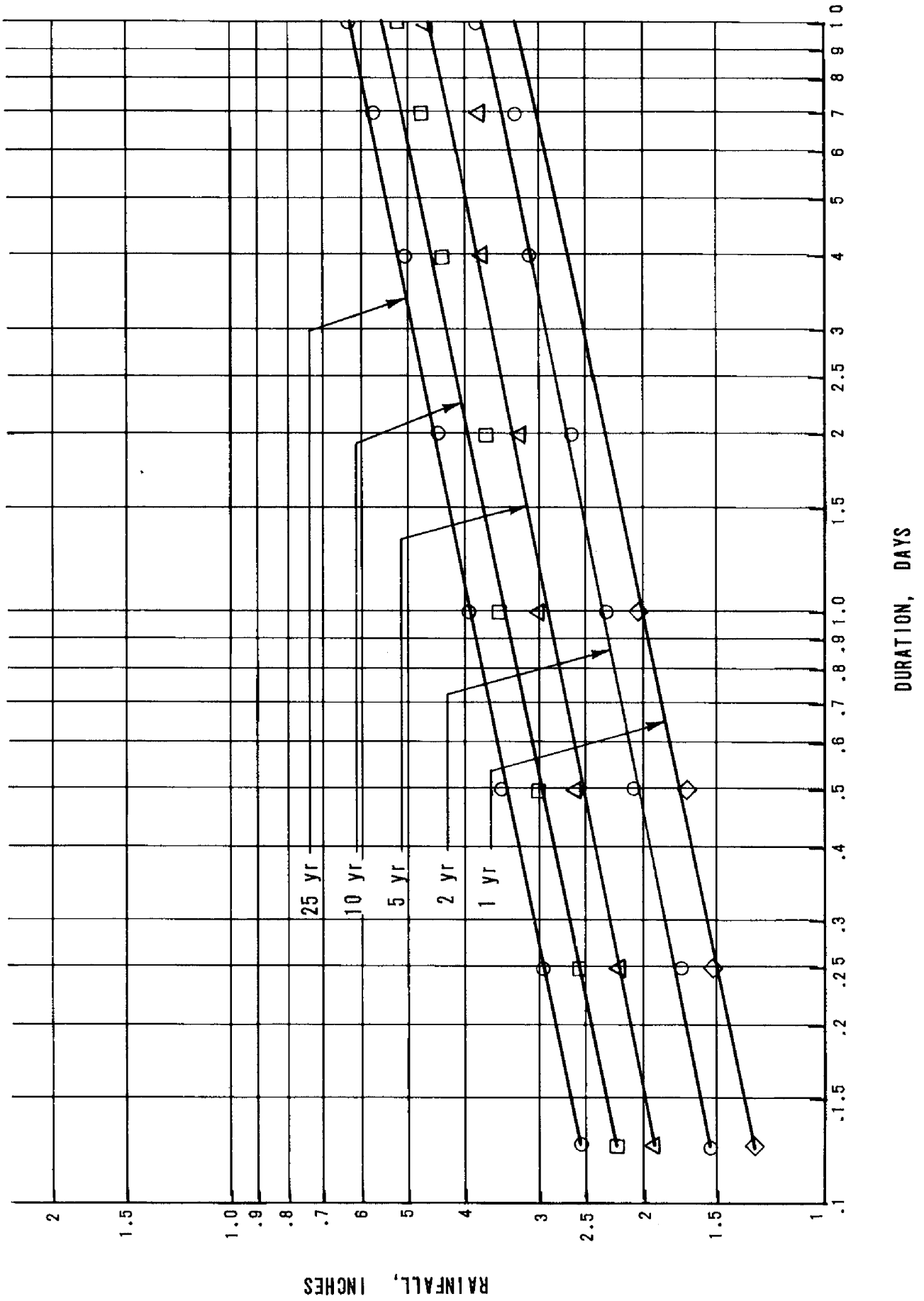

Figure 7A-2, Rainfall duration-frequency

The computed hydrograph base values are shown in table 7A-2.

Table 7A-2, Hydrograph base time length

| Duration, Days | Hydrograph Base Time T_b , Days |
|-------------------|--------------------------------------|
| 0.125 | 0.65 |
| 0.250 | 0.81 |
| 0.500 | 1.15 |
| 1.000 | 1.82 |
| 2.000 | 3.16 |
| 4.000 | 5.82 |
| 7.000 | 9.84 |
| 10.000 | 13.85 |

Mass runoff curves are prepared as shown in figure 7A-3 by plotting accumulated runoff for the various durations and frequencies against time of the hydrograph bases.

Runoff, pumping rate, storage relationships

By plotting pumping rates against time of the hydrograph base as shown in figure 7A-3, the maximum storage for each pumping rate and frequency can be determined by measurement of the maximum increment between the pumping rate line and the mass runoff curve. This is done by drawing a line representing the pumping rate tangent to the mass runoff line. Where this line intercepts the runoff on the vertical axis, the maximum required storage for the given frequency and pumping rate is indicated. These storage values are shown in table 7A-3 and are plotted against percent chance of occurrence for each pumping rate as shown in figure 7A-4.

Table 7A-3, Required maximum storage, inches

| Pumping Rate Inches/Day | Frequency | | | | |
|----------------------------|-----------|--------|--------|---------|---------|
| | 1-Year | 2-Year | 5-Year | 10-Year | 25-Year |
| 0 | 1.42 | 1.72 | 2.46 | 3.13 | 3.75 |
| 0.1 | 0.41 | 0.64 | 1.27 | 1.83 | 2.40 |
| 0.2 | 0.12 | 0.30 | 0.76 | 1.17 | 1.62 |
| 0.3 | 0 | 0.14 | 0.53 | 0.89 | 1.27 |
| 0.5 | | 0 | 0.25 | 0.54 | 0.83 |
| 0.7 | | | 0 | 0.30 | 0.53 |
| 1.0 | | | | 0 | 0.17 |
| 1.5 | | | | | 0 |

The area under each curve, determined by planimeter measurement, gives the average annual storage requirement for each pumping rate as shown in table 7A-4 and from which the curve shown in figure 7A-5 is developed.

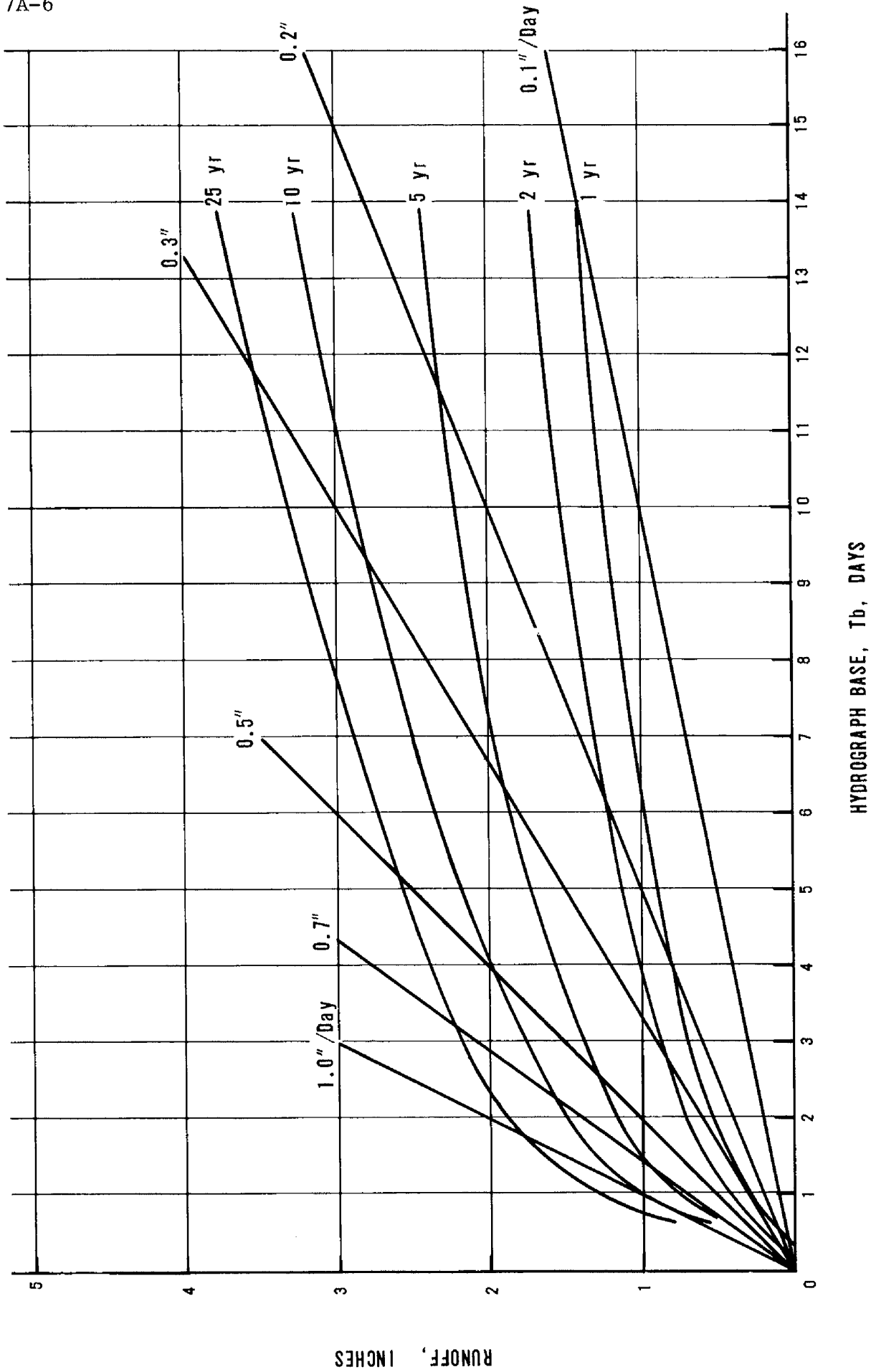

Figure 7A-3, Mass runoff, frequency, duration, and pumping rate relationships

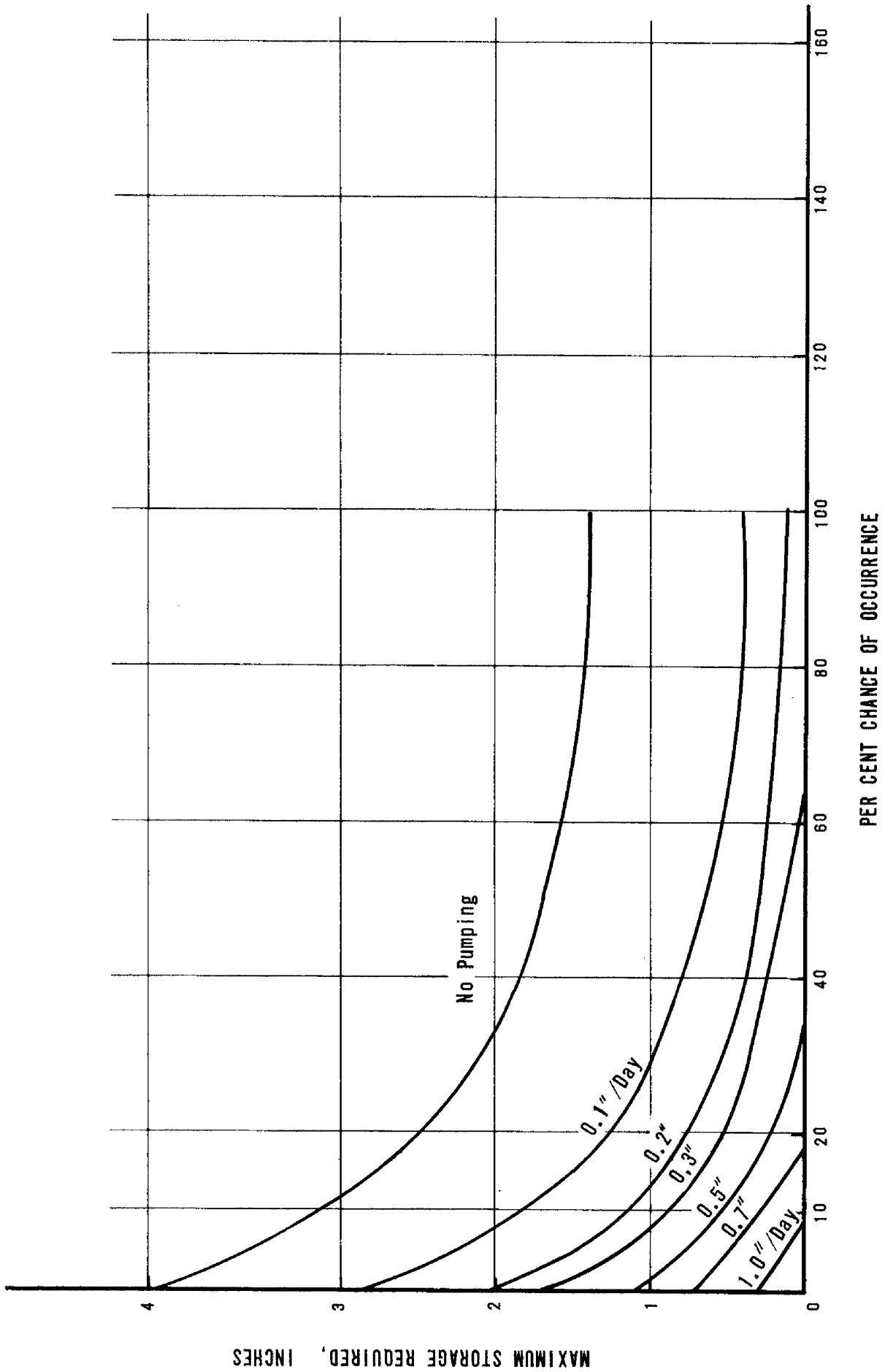

Figure 7A-4, Maximum required storage for various chances of occurrence and pumping rates

Table 7A-4, Average annual storage for various pumping rates

| Pumping Rate Inches/Day | Area Under Curve, Sq.In. | Value Per Unit | Average Annual Storage, Inches |
|----------------------------|-----------------------------|-------------------|-----------------------------------|
| 0 | 10.09 | 1 x .2 = 0.2 | 2.02 |
| 0.1 | 4.48 | 1 x .2 = 0.2 | 0.90 |
| 0.2 | 2.45 | 1 x .2 = 0.2 | 0.49 |
| 0.3 | 1.46 | 1 x .2 = 0.2 | 0.29 |
| 0.5 | 0.68 | 1 x .2 = 0.2 | 0.14 |
| 0.7 | 0.35 | 1 x .2 = 0.2 | 0.07 |
| 1.0 | 0.08 | 1 x .2 = 0.2 | 0.02 |

Stage-storage relationships

A topographic survey of the area is made from which a topographic map is prepared for determining the stage-storage relationships. Two-foot contour intervals (preferably 1-foot) are established from which mapped surface areas at the several elevations are measured by planimeter. Stage, area, storage relationships are then determined as tabulated in table 7A-5.

Table 7A-5, Stage, area, storage relationships

| Elev. MSL | Stage Feet | Total Area Acres | Cultivated Area - Acres | Storage Acre Feet | Cumulative Storage Acre Feet | Cumulative Storage Inches |
|--------------|---------------|------------------------|----------------------------|----------------------|------------------------------------|---------------------------------|
| 651 | 0 | 0 | 0 | 0 | 0 | 0 |
| 652 | 1 | 10 | 0 | 5 | 5 | 0.004 |
| 653 | 2 | 29 | 0 | 20 | 25 | 0.020 |
| 654 | 3 | 62 | 0 | 46 | 71 | 0.060 |
| 655 | 4 | 229 | 0 | 146 | 217 | 0.170 |
| 656 | 5 | 1100 | 784 | 665 | 882 | 0.690 |
| 657 | 6 | 1536 | 1176 | 1318 | 2200 | 1.720 |
| 658 | 7 | 2010 | 1603 | 1773 | 3973 | 3.110 |
| 659 | 8 | 2545 | | 2278 | 6251 | 4.890 |
| 660 | 9 | 2997 | | | | |

Stage, damage area, benefit area relationships

Information in table 7A-5 is used to establish relationships between stage and the areas of flooding and areas of impaired drainage.

Area flooded is the total surface area at each elevation. Impaired drainage is determined on the basis of normal depth of tile below the surface (3 feet in Michigan) plus an added foot to allow for the tile slope toward the outlet. Drainage impairment is considered as occurring when the resulting elevation of tile is submerged. When the pump storage area is flooded to a specified elevation, the area at an elevation of 4 feet above the specified elevation, less the flood area at the specified elevation, then becomes the area of drainage impairment. Table 7A-6 gives these values. Relationships of elevation to storage, cultivated and flooded, and area of impaired drainage can then be determined as shown in figure 7A-6.

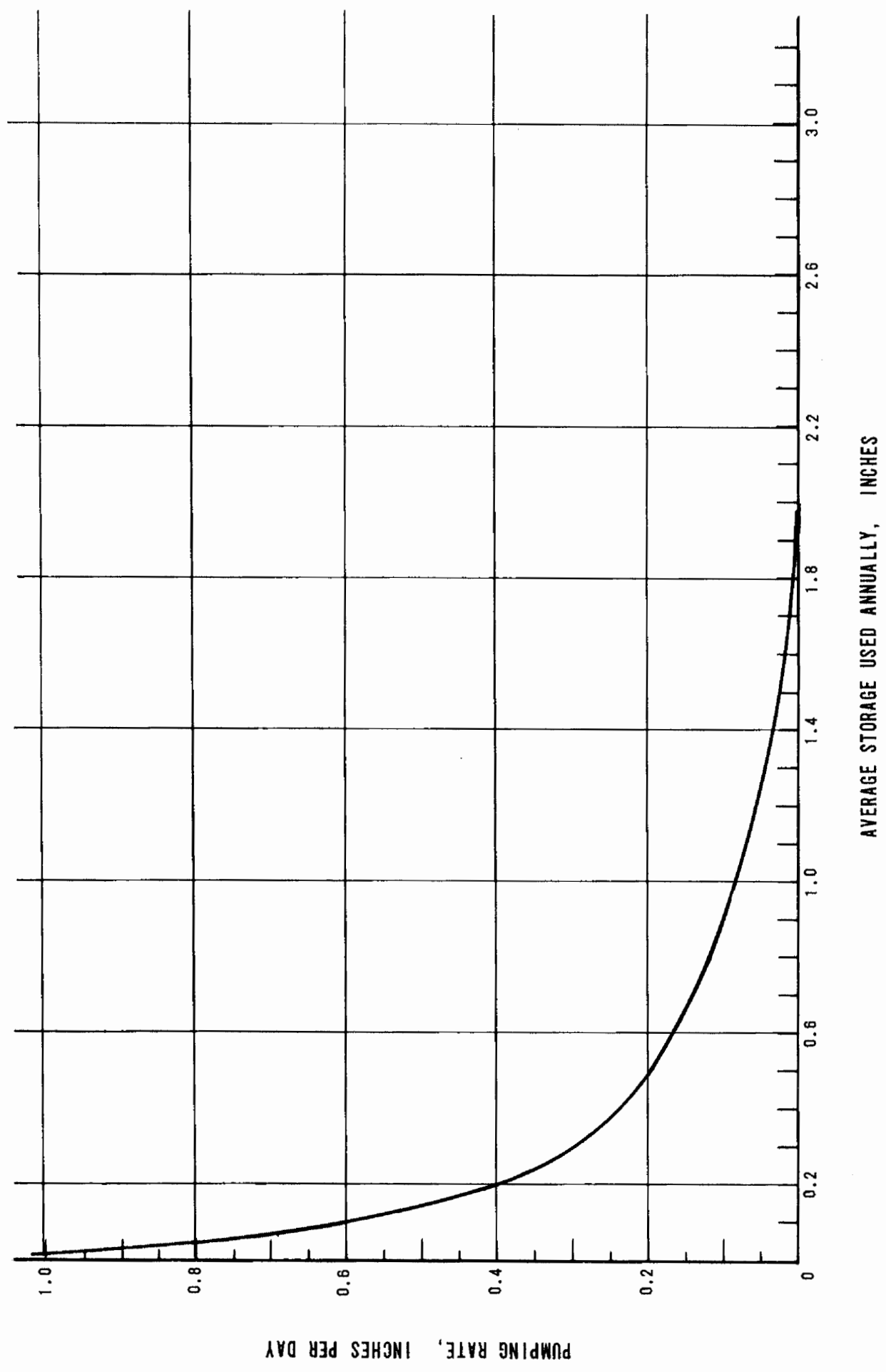

Figure 7A-5, Average annual storage at various pumping rates

Table 7A-6, Relationships - stage to impaired drainage area

| Elevation MSL | Surface Acres | Flooded Acres | Total Affected Acres | Impaired Drainage Acres |
|------------------|------------------|------------------|----------------------------|-------------------------------|
| 651 | 0 | 0 | 0 | 0 |
| 652 | 10 | 10 | 1,100 | 1,090 |
| 653 | 29 | 29 | 1,536 | 1,507 |
| 654 | 62 | 62 | 2,010 | 1,948 |
| 655 | 229 | 229 | 2,545 | 2,316 |
| 656 | 1,100 | 1,100 | 2,997 | 1,897 |
| 657 | 1,536 | 1,536 | 3,560 | 2,024 |
| 658 | 2,010 | 2,010 | 4,120 | 2,110 |
| 659 | 2,545 | 2,545 | 4,685 | 2,140 |
| 660 | 2,997 | | | |
| 661 | 3,560 | | | |
| 662 | 4,120 | | | |
| 663 | 4,685 | | | |

Pumping rate, storage, and damage area relationships

From the established relationships of pumping rates, annual storage, storage elevations, and related area flooded, the area of benefit is determined. These relationships and their sources are shown in table 7A-7.

Table 7A-7, Relationships - stage, storage, pumping rate, and affected acres

| Pumping Rate Inches/Day | Average Annual Storage Used Inches Fig. 7A-4 | Related Sump Elevation MSL Fig. 7A-5 | Average Annual Area Flooded Acres Fig. 7A-5 | Average Annual Area Benefited by Reduced Flooding Acres |
|----------------------------|--|---|---|---|
| 0.00 | 2.02 | 657.25 | 1290 | 0 |
| 0.10 | 0.90 | 656.25 | 875 | 415 |
| 0.20 | 0.49 | 655.70 | 570 | 720 |
| 0.25 | 0.39 | 655.50 | 405 | 885 |
| 0.30 | 0.32 | 655.37 | 285 | 1005 |
| 0.35 | 0.25 | 655.20 | 160 | 1130 |
| 0.40 | 0.20 | 655.08 | 70 | 1220 |
| 0.45 | 0.16 | 654.90 | 0 | 1290 |
| 0.50 | 0.14 | 654.80 | 0 | 1290 |
| 0.60 | 0.09 | 654.30 | 0 | 1290 |
| 0.70 | 0.07 | 654.10 | 0 | 1290 |
| 0.80 | 0.04 | 653.60 | 0 | 1290 |
| 0.90 | 0.03 | 653.20 | 0 | 1290 |
| 1.00 | 0.02 | 652.80 | 0 | 1290 |

Value of damages and benefits

Flood damages occur through reduction in yields, increased production costs, and reduction in crop quality. From an economic study (based on a complex economic model evaluating such factors not explained herein), an average annual flood damage of \$22.57 per cultivated acre has been determined. This value also represents the benefits accruing to each acre for which flooding

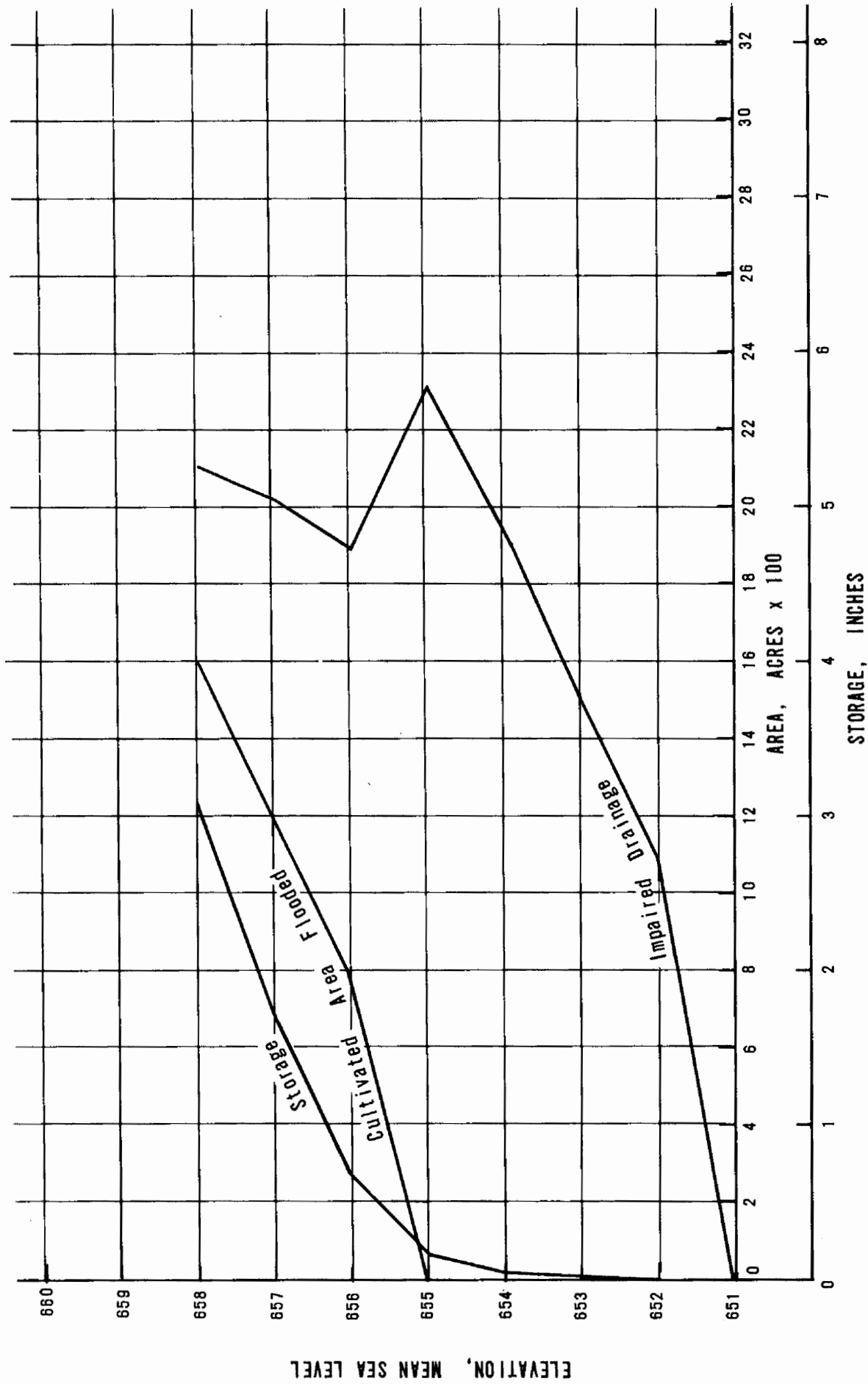

Figure 7A-6, Relationships of stage, storage, and affected areas

is prevented. Applying this value to the acres benefited, the average annual flood damage reduction for each pumping rate is determined as shown in table 7A-8.

Table 7A-8, Relationships - pumping rate to benefits

| Pumping Rate Inches/Day | Area Benefited Annually-Acres | Benefits Dollars/Acres | Annual Benefits Dollars |
|----------------------------|----------------------------------|---------------------------|----------------------------|
| 0 | 0 | 22.57 | 0 |
| 0.10 | 415 | 22.57 | 9,367 |
| 0.20 | 720 | 22.57 | 16,250 |
| 0.25 | 885 | 22.57 | 19,974 |
| 0.30 | 1,005 | 22.57 | 22,683 |
| 0.35 | 1,130 | 22.57 | 25,504 |
| 0.40 | 1,220 | 22.57 | 27,535 |
| 0.45 | 1,290 | 22.57 | 29,115 |
| 0.50 | 1,290 | 22.57 | 29,115 |
| 0.60 | 1,290 | 22.57 | 29,115 |
| 0.70 | 1,290 | 22.57 | 29,115 |
| 0.80 | 1,290 | 22.57 | 29,115 |
| 0.90 | 1,290 | 22.57 | 29,115 |
| 1.00 | 1,290 | 22.57 | 29,115 |

The effect of impaired drainage is evaluated. Plotted mass curves and pumping rates of figure 7A-3 are used to determine the storage required each day for various frequencies and pumping rates. Table 7A-9 shows the data for no pumping and for a pumping rate of one-half inch per day. Other pumping rates are evaluated (not shown herein). Figure 7A-6 is used to convert storage to acres of impaired drainage. Information for duration of impaired drainage at a pumping rate of one-half inch per day is shown in figure 7A-7.

From a crop budgetary model (not explained herein), the average annual damage from impaired drainage caused by reduced yields, increased production cost, and reduced crop quality is determined to be \$14.85 per cultivated acre. This also represents the net benefit obtained by drainage, allowing for the on-farm cost of drainage improvement.

It is assumed that drainage impairment for 3 days or less causes no measurable crop damage, that impairment during the growing season for 21 days or more causes damage equal to that on land without installed drains, and that a linear relationship exists between damage value and duration of impairment. Thus average damage per day of duration can be taken to be \$0.825.

From plottings of acres of impaired drainage and days duration for the various frequencies and pumping rates, the acre days of impaired drainage exceeding 3 days duration are measured. Since damage of impaired drainage is for more than 3 and less than 21 days, the acre days for no pumping are 18 times the acres effected. This information is shown in table 7A-10. Damage for various pumping rates and frequencies is then determined on the basis of \$0.825 per acre day. Total damages are determined by plotting damages against percent chance of occurrence and measuring the area under the curve as shown in figures 7A-8 and 7A-9 for no pumping and for pumping one-half inch a day, respectively. Other rates are measured next and then tabulated as shown in table 7A-11. This table shows flood and impaired drainage damages and corresponding weighted benefits by seasonal storm distribution. Total average annual benefits are plotted as shown in figure 7A-10.

Table 7A-9, Relationships - impaired drainage and storage for various frequencies and pumping rates

| Pumping Rate | Time After Runoff Begins Days | 1-Year Frequency Storage Required | | 2-Year Frequency | | 5-Year Frequency | | 10-Year Frequency | | 25-Year Frequency | |
|--------------|-------------------------------|-----------------------------------|-------|------------------|-------|------------------|-------|-------------------|-------|-------------------|-------|
| | | Inches | Acres | Inches | Acres | Inches | Acres | Inches | Acres | Inches | Acres |
| No Pumping | Maximum | 1.41 | 1,990 | 1.71 | 2,025 | 2.45 | 2,070 | 3.13 | 2,110 | 3.74 | 2,120 |
| 0.5 In./Day | 1 | 0 | - | 0 | - | 0.24 | 2,210 | 0.50 | 2,020 | 0.72 | 1,900 |
| | 2 | | | | | 0.15 | 2,215 | 0.49 | 2,020 | 0.83 | 1,920 |
| | 3 | | | | | 0 | - | 0.28 | 2,180 | 0.65 | 1,920 |
| | 4 | | | | | | | 0 | - | 0.42 | 2,080 |
| | 5 | | | | | | | | | 0.12 | 2,110 |

IMPAIRED DRAINAGE, ACRES x 100

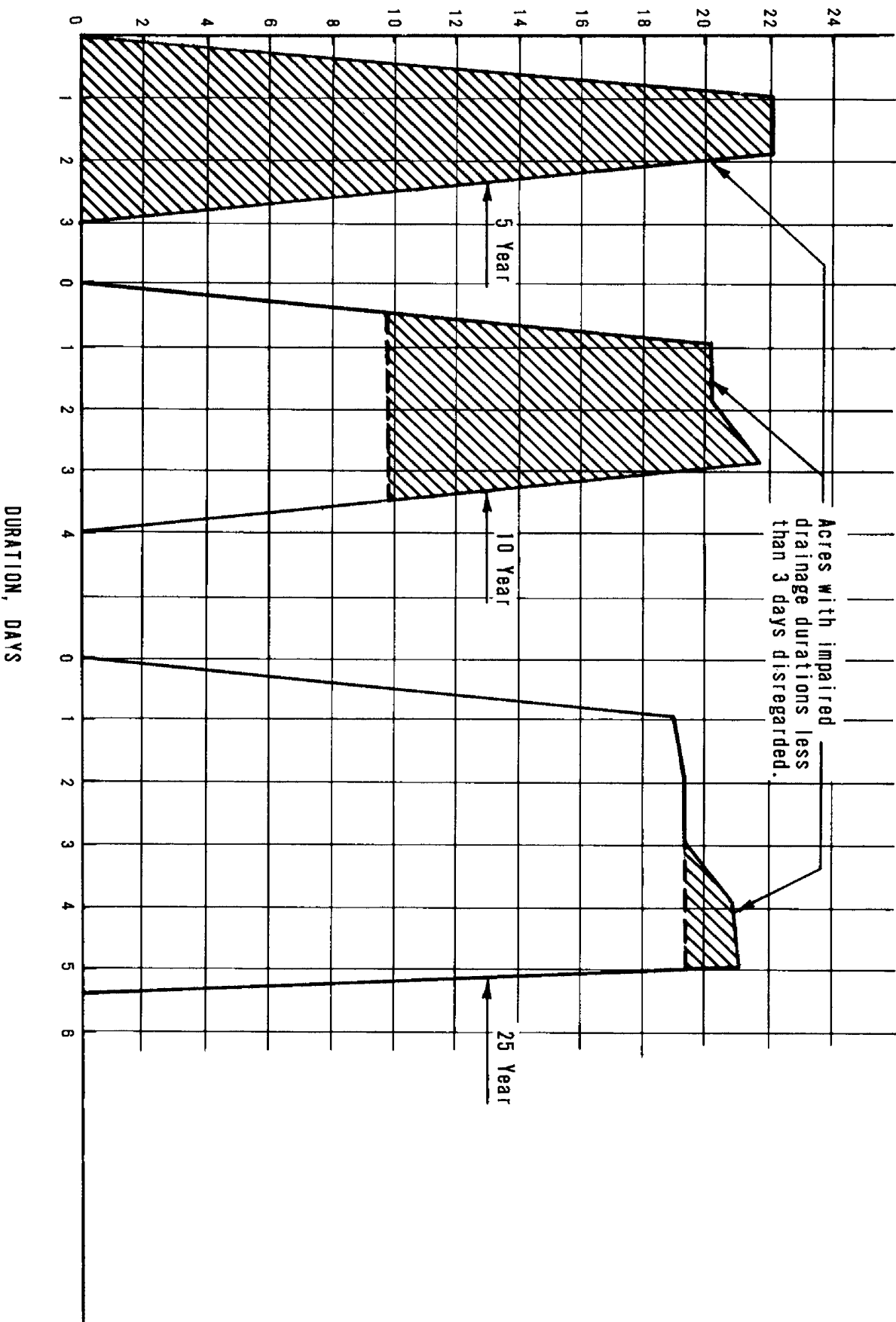

Figure 7A-7, Acre-days impaired drainage at 1/2 inch pumping rate for various frequencies

Table 7A-10, Damages for various pumping rates and frequencies of occurrence

| Pumping Rate Inch/Day | Frequency of Occurrence Year | Area Under Curve Sq.In. | Value per Unit | Impaired Drainage Acre-Day | Damages \$0.825 Per Acre-Day | Total Damage Dollars |
|--------------------------|---------------------------------------|----------------------------------|-------------------|----------------------------------|------------------------------------|----------------------------|
| 0.6 | 1 | 0 | 400 x 2 | 0 | 0.825 | 0 |
| | 2 | 0 | = 800 | 0 | | 0 |
| | 5 | 0 | | 0 | | 0 |
| | 10 | 0 | | 0 | | 0 |
| | 25 | 4.55 | | 3,640 | | 3,000 |
| 0.5 | 1 | 0 | 400 x 2 | 0 | | 0 |
| | 2 | 0 | = 800 | 0 | | 0 |
| | 5 | 0 | | 0 | | 0 |
| | 10 | 4.24 | | 3,392 | | 2,800 |
| | 25 | 11.21 | | 8,975 | | 7,400 |
| 0.45 | 1 | 0 | 400 x 2 | 0 | | 0 |
| | 2 | 0 | = 800 | 0 | | 0 |
| | 5 | 0.60 | | 480 | | 396 |
| | 10 | 9.35 | | 7,480 | | 6,175 |
| | 25 | 13.45 | | 10,560 | | 8,720 |
| 0.4 | 1 | 0 | 400 x 2 | 0 | | 0 |
| | 2 | 0 | = 800 | 0 | | 0 |
| | 5 | 4.30 | | 3,440 | | 2,840 |
| | 10 | 12.70 | | 9,650 | | 7,960 |
| | 25 | 16.99 | | 13,600 | | 11,220 |
| 0.3 | 1 | 0 | 400 x 2 | 0 | | 0 |
| | 2 | 0 | = 800 | 0 | | 0 |
| | 5 | 14.80 | | 11,840 | | 9,770 |
| | 10 | 19.62 | | 15,700 | | 12,950 |
| | 25 | 26.89 | | 21,500 | | 17,730 |
| 0 | 1 | | 400 x 2 | 35,820 | | 29,550 |
| | 2 | | = 800 | 36,450 | | 30,100 |
| | 5 | | | 37,260 | | 30,700 |
| | 10 | | | 37,980 | | 31,350 |
| | 25 | | | 38,160 | | 31,500 |

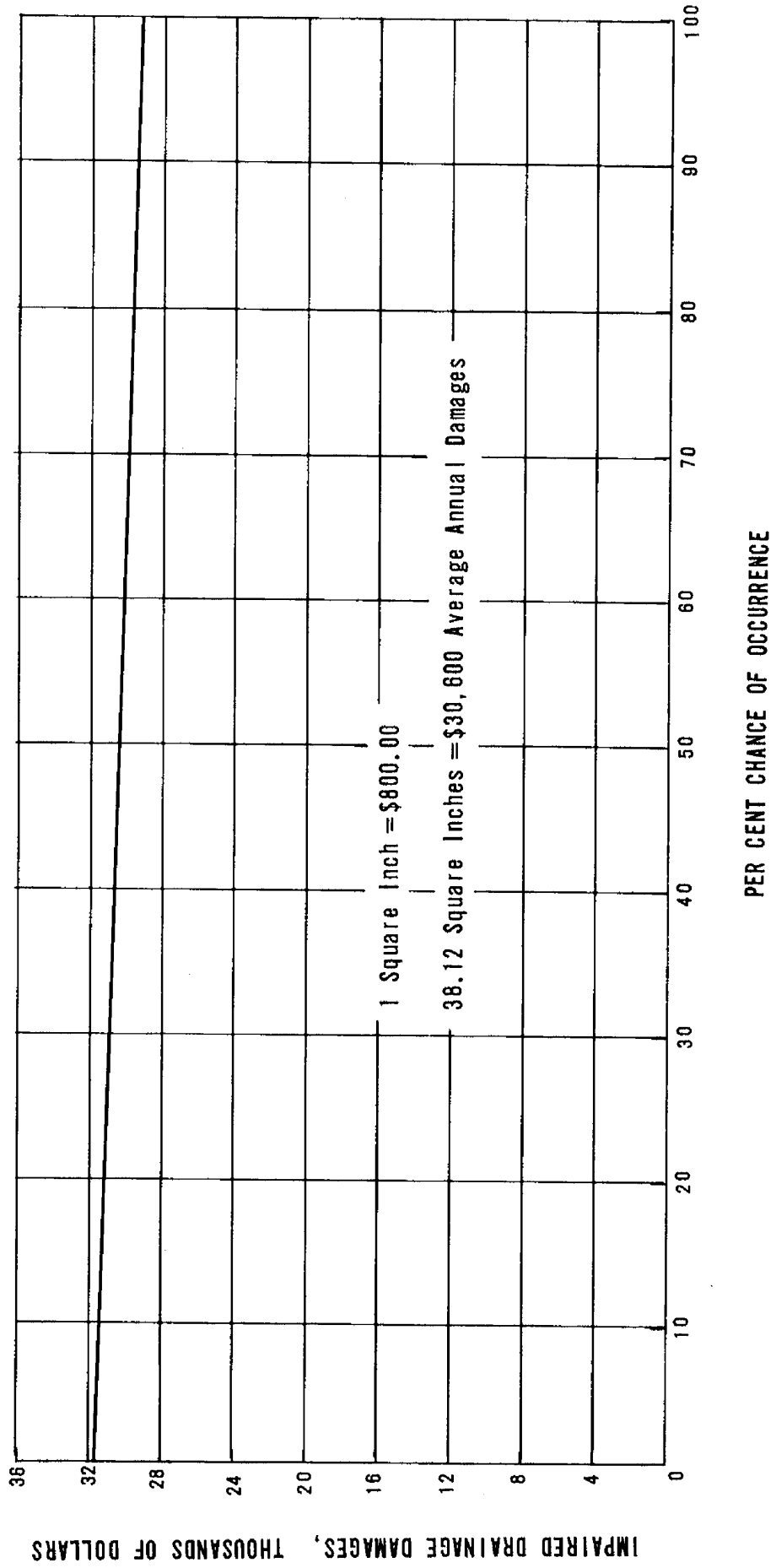

Figure 7A-8, Impaired drainage damages with no pumping

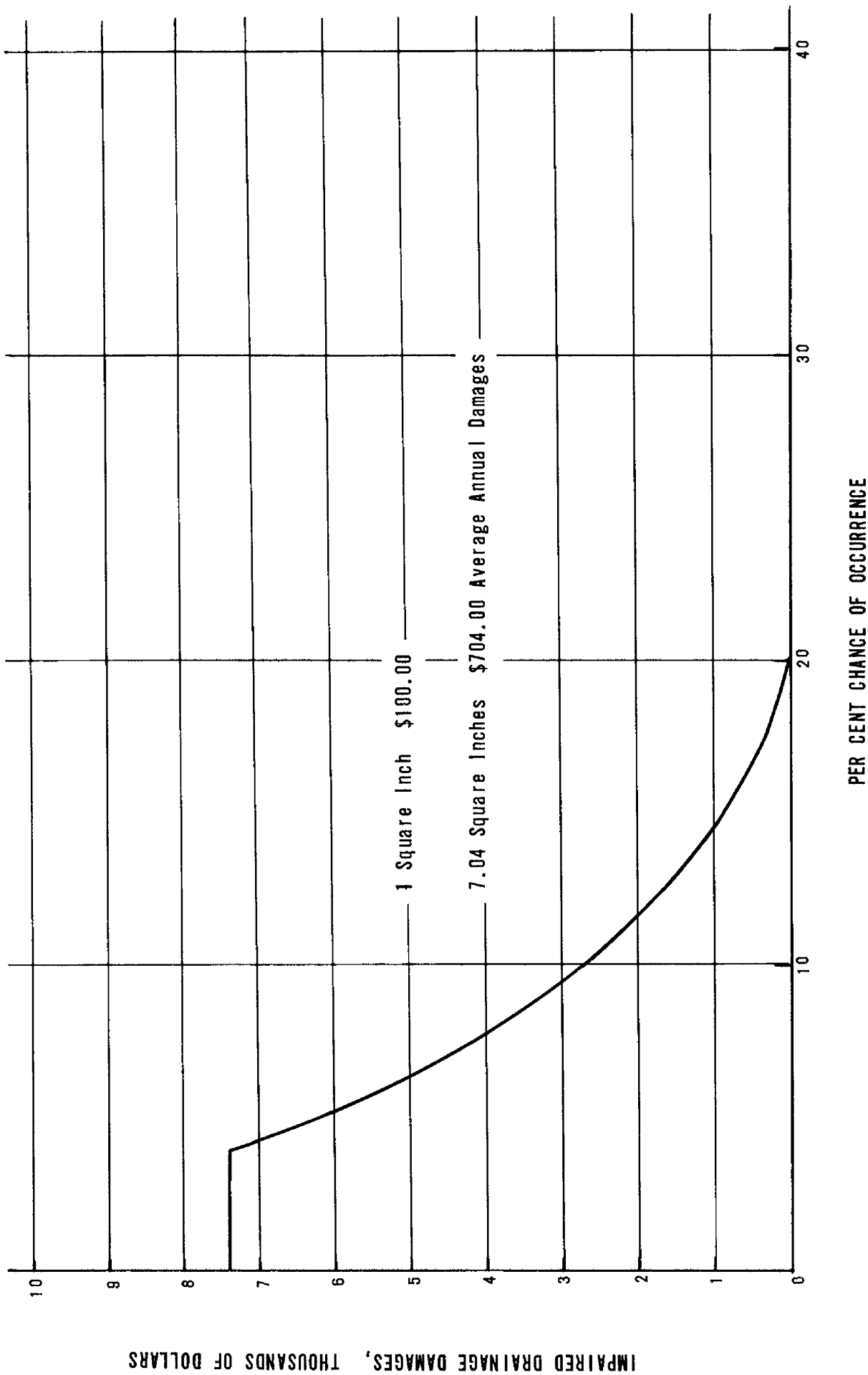

Figure 7A-9, Value of damage by impaired drainage at 1/2 inch per day pumping rate

IMPAIRED DRAINAGE DAMAGES, THOUSANDS OF DOLLARS

Table 7A-11, Average annual damages and benefits for various pumping rates

| Pumping Rate Inches/ Day | Area Flooded | | | | Area With Impaired Drainage | | | |
|--------------------------------|------------------------------------|---------------------------------------|------------------------------------|-----------------------------|--------------------------------|---------------------------------|--|--|
| | Average Annual Area Flooded Cult A | Average Annual Area Benefitted Cult A | Damages @ 22.57 Per Cult A Dollars | Benefits Per Cult A Dollars | Average Annual Damages Dollars | Average Annual Benefits Dollars | Weighted Average Annual Benefits Dollars | |
| 0 | 1290 | 0 | 29,115 | 0 | 30,600 | 0 | 0 | |
| 0.1 | 875 | 415 | 2/ | 2/ | 2/ | 2/ | 2/ | |
| 0.2 | 570 | 720 | 2/ | 2/ | 2/ | 2/ | 2/ | |
| 0.3 | 285 | 1005 | 6,432 | 22,683 | 4,444 | 26,156 | 18,126 | |
| 0.4 | 70 | 1220 | 1,580 | 27,535 | 1,906 | 28,694 | 19,885 | |
| 0.5 | 0 | 1290 | 0 | 29,115 | 704 | 29,896 | 20,718 | |
| 0.6 | 0 | 1290 | 0 | 29,115 | 200 | 30,400 | 21,067 | |

1/ Weighted by 63.9 percent of excessive storms which occur during the growing season (April through November).

2/ Not evaluated because pumping rates less than 0.3 inch per day are usually considered inadequate.

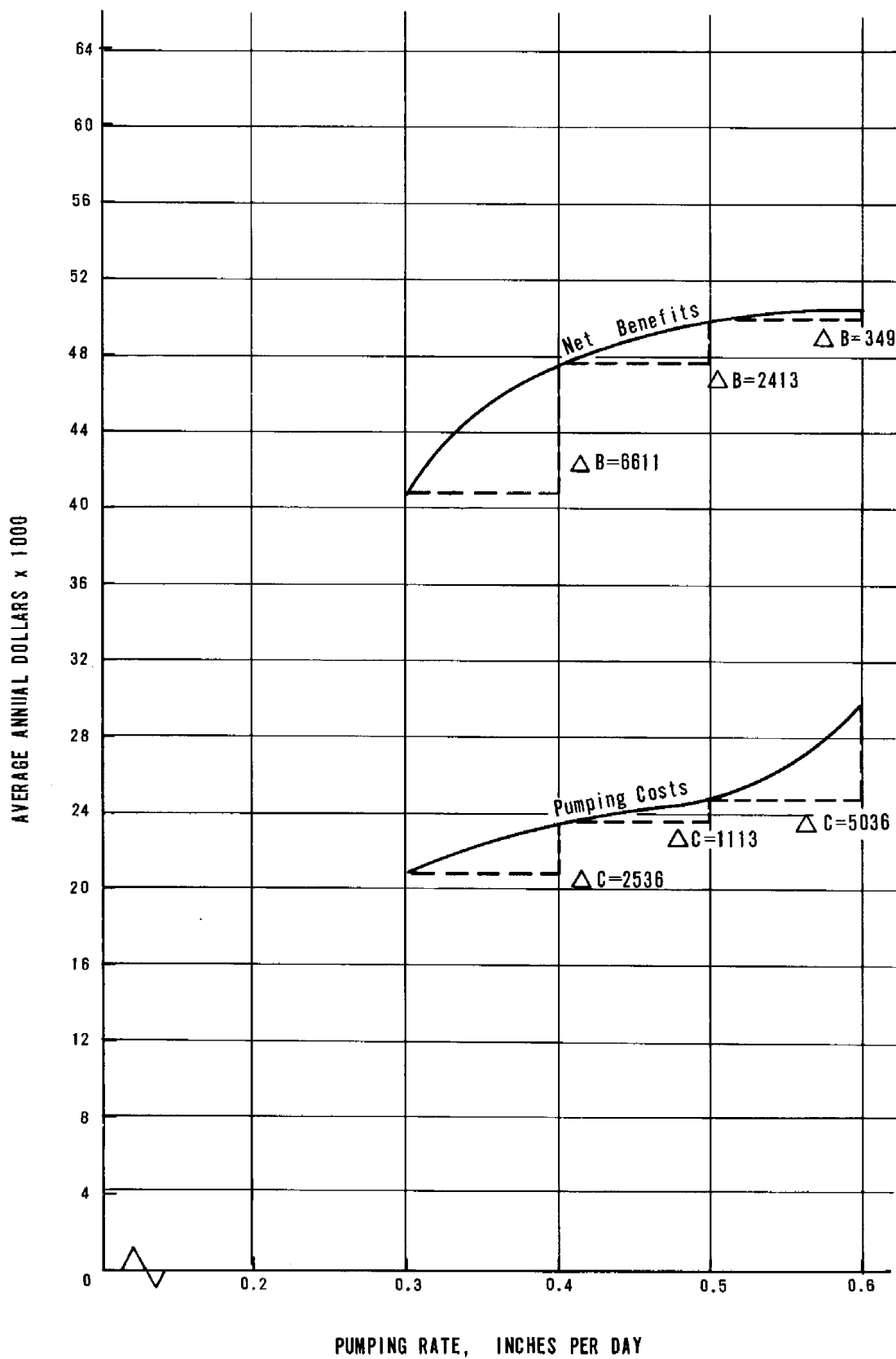

Figure 7A-10, Cost-benefit relationship at various pumping rates

Operating costs

To optimize benefits a relationship is needed between pumping rates and total costs. Costs fall into two categories. The first includes cost of the pumping plant installation, including the sump and housing, the pumps, power units, land rights, engineering, and installation. The second includes the cost of power, operation, maintenance, and equipment replacement.

Since gravity outlet will be obtained at low river flows, percent of total runoff pumped is determined as follows: The main channel discharge at which pumping must begin is computed in cubic feet per second and cubic feet per second per square mile. Since discharge records for Maple River watershed were not available, the cubic feet per second per square mile rate is applied as a base determined from the Red Cedar River at East Lansing, which is a nearby gaged watershed of similar size and characteristics. Dates when the discharge exceeded the estimated base flow are tabulated for 9 years of record. Deer Creek, a small gaged watershed within the Red River watershed, draining an area of 16.3 square miles, is used to determine the volume of runoff occurring when the Red Cedar was above base flow. The percent runoff above the base, as compared to total runoff, is then applied to the Maple River runoff to determine the volume of runoff that must be pumped. These data also provide a seasonal distribution for pumping by months, used in determining operating costs.

Installation costs and equipment replacement costs are amortized and added to annual operating costs to obtain a total average annual cost. These data are listed in table 7A-12 and plotted in figure 7A-10.

Table 7A-12, Cost-benefits at various pumping rates

| Pumping Rate Inches/Day | Total Average Annual Damages ^{1/} Dollars | Total Average Annual Benefits Dollars | Total Average Annual Pump Costs Dollars |
|----------------------------|---|--|--|
| 0 | 46,713 | 0 | 0 |
| 0.1 | <u>2/</u> | <u>2/</u> | <u>2/</u> |
| 0.2 | <u>2/</u> | <u>2/</u> | <u>2/</u> |
| 0.3 | 8,988 | 40,809 | 20,915 |
| 0.4 | 2,676 | 47,420 | 23,451 |
| 0.5 | 405 | 49,833 | 24,564 |
| 0.6 | 115 | 50,182 | 29,600 |

^{1/} Flood damages plus weighted drainage damages from table 7A-11.

^{2/} Not evaluated because pumping rates less than 0.3 inch per day are usually considered inadequate

Pumping rate at optimum cost-benefit ratio

Optimization criteria are based on an equimarginal principle in which additional units of input are added until cost of the last unit of input equals the value of the unit so produced. Thus optimum pumping rate occurs when an incremental increase in the pumping rate just equals the added benefits derived by removing water at the higher rate, or the slope of the cost curve equals

the slope of the benefit curve. As shown in figure 7A-10 and table 7A-13, moving from the 0.3-inch to the 0.4-inch rate, benefits increase \$6,611 whereas costs increase only \$2,536. In moving from the 0.4-inch to the 0.5-inch rate, benefits increase \$2,413 whereas costs increase \$1,113. However, in moving from the 0.5-inch to the 0.6-inch rate, benefits increase only \$349 whereas costs increase \$5,036. Then somewhere between the 0.5-inch and 0.6-inch rate is the appropriate pumping rate to use. Considering the accuracy of topographic coverage and the cost spread between increments, the 0.5-inch is selected.

Table 7A-13, Relationships - cost-benefit at various pumping rates

| Pumping Rate | Change in Benefits | Change in Costs |
|--------------|--------------------|-----------------|
| 0.3 | - | - |
| 0.4 | 6,611 | 2,536 |
| 0.5 | 2,413 | 1,113 |
| 0.6 | 349 | 5,036 |

APPENDIX B

Design of Farm Drainage Pumping PlantExample

A pumping plant is required to remove runoff from 236 acres of low land on a 440-acre farm near Bayou John, Louisiana in order to grow sugarcane. Drainage of higher land on the farm has been diverted from the low area to an adequate gravity outlet. The low land is protected from tidal overflow by a border dike constructed from materials excavated from adjoining ditches within the protected area. The land lacks sufficient elevation for adequate gravity drainage into the tidal outlet. Surveys show ground elevation in low areas at -1.0 mean sea level and near the proposed pump site at -1.5 msl. Elevation in bottom of ditch at the pump site is -5.5 msl. Average yearly high tide is El. 2.0 msl and a 10-year frequency high water is El. 3.0 msl. Soils are poorly drained Sharkey clay loam which permit little seepage into the area and provide no appreciable ground water storage or field ditch storage for runoff in the required surface drainage system. Some storage is available in the borrow ditches along the dikes. A gasoline engine will be used to supply power to the pump to be housed over a concrete sump. Pump discharge will be piped over the dike.

Pump plant location

The pumping plant will be located within several hundred feet of Point A as shown in general layout figure 7B-1 and between the dike and borrow ditch.

Pump plant capacity

The pump capacity will be the required runoff removal rate for the 236 acres at 3 inches in 24 hours as determined from the local drainage guide, less the storage available in the borrow ditches which is equal to 0.43 inch, or a net rate of 2.57 inches in 24 hours.

$$\begin{aligned} \text{Pump capacity} &= \frac{\begin{array}{cccc} \text{(ac.)} & & \text{(sq.ft./ac.)} & \\ 236 & \times & 43,560 & \times \end{array}}{\begin{array}{ccc} 12 & & 24 \\ \text{(in./ft)} & & \text{(hrs./day)} \end{array}} \times \frac{\begin{array}{cc} \text{(in/day)} & \\ 2.57 & \times \end{array}}{\begin{array}{c} 60 \\ \text{(min./hr.)} \end{array}} \times \begin{array}{c} \text{(gal./cu.ft.)} \\ 7.48 \end{array} \\ &= 11,436 \text{ GPM} \end{aligned}$$

Pump type and size

Stage in the sump will fluctuate between -5.5 feet and -1.5 feet with an average stage of -3.5 feet. Minimum static head will be 4.5 feet (-1.5' msl to +3.0' msl). Maximum static head will occur when the sump is empty, equal to 8.5 feet (-5.5' msl to +3.0' msl), and is expected to be of short duration. (See figure 7B-2.) Pump selection, therefore, may be based on average static head, but the power supply on maximum static head to avoid possible engine overload when pumping at the maximum head.

Based on little seepage, moderate capacity, and low risk damage in case of temporary pump failure, only one pump will be used. Based on low pumping head and moderate capacity (also see selection chart figure 7-4) and

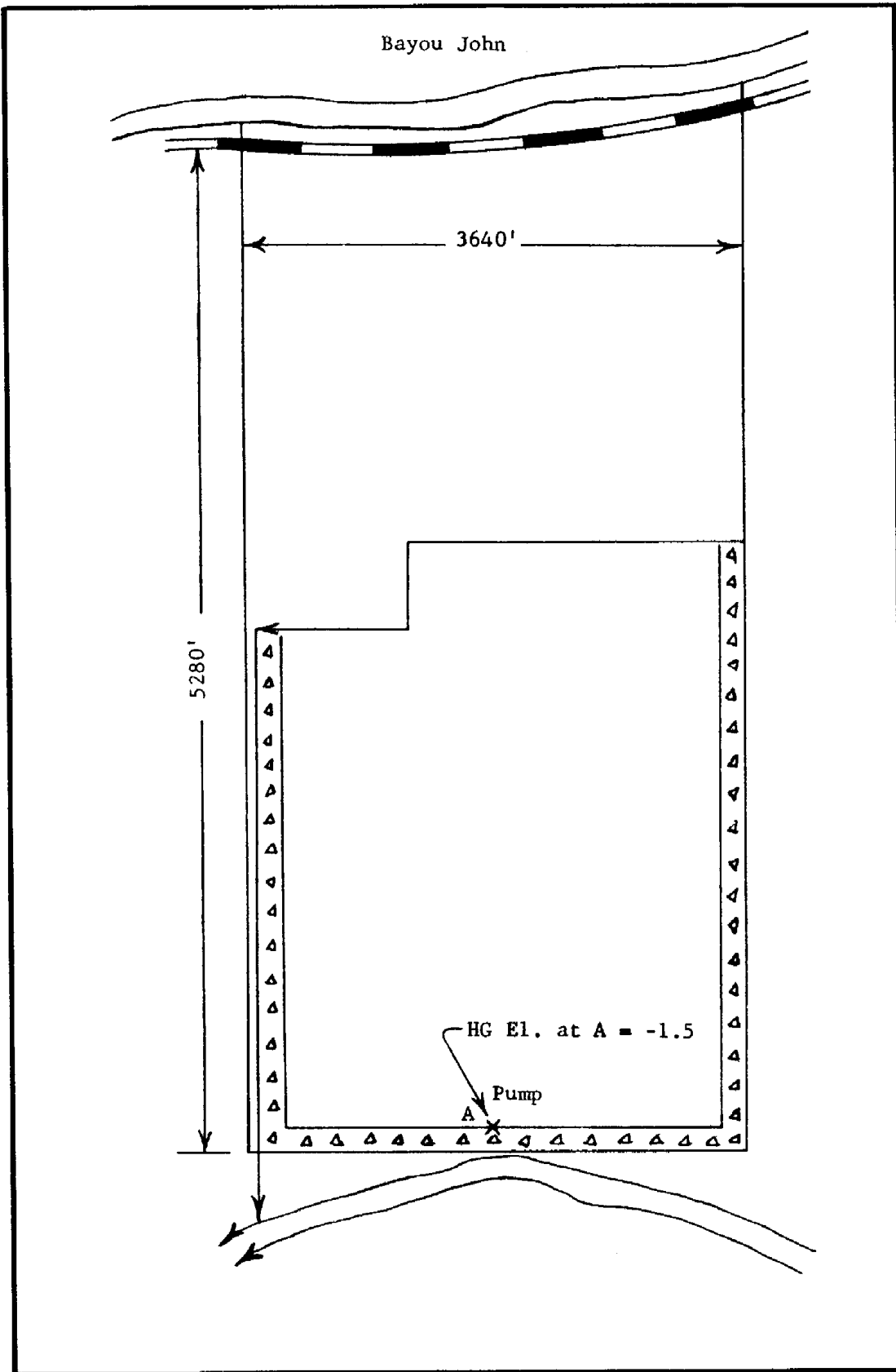

Figure 7B-1, Pump drainage site layout

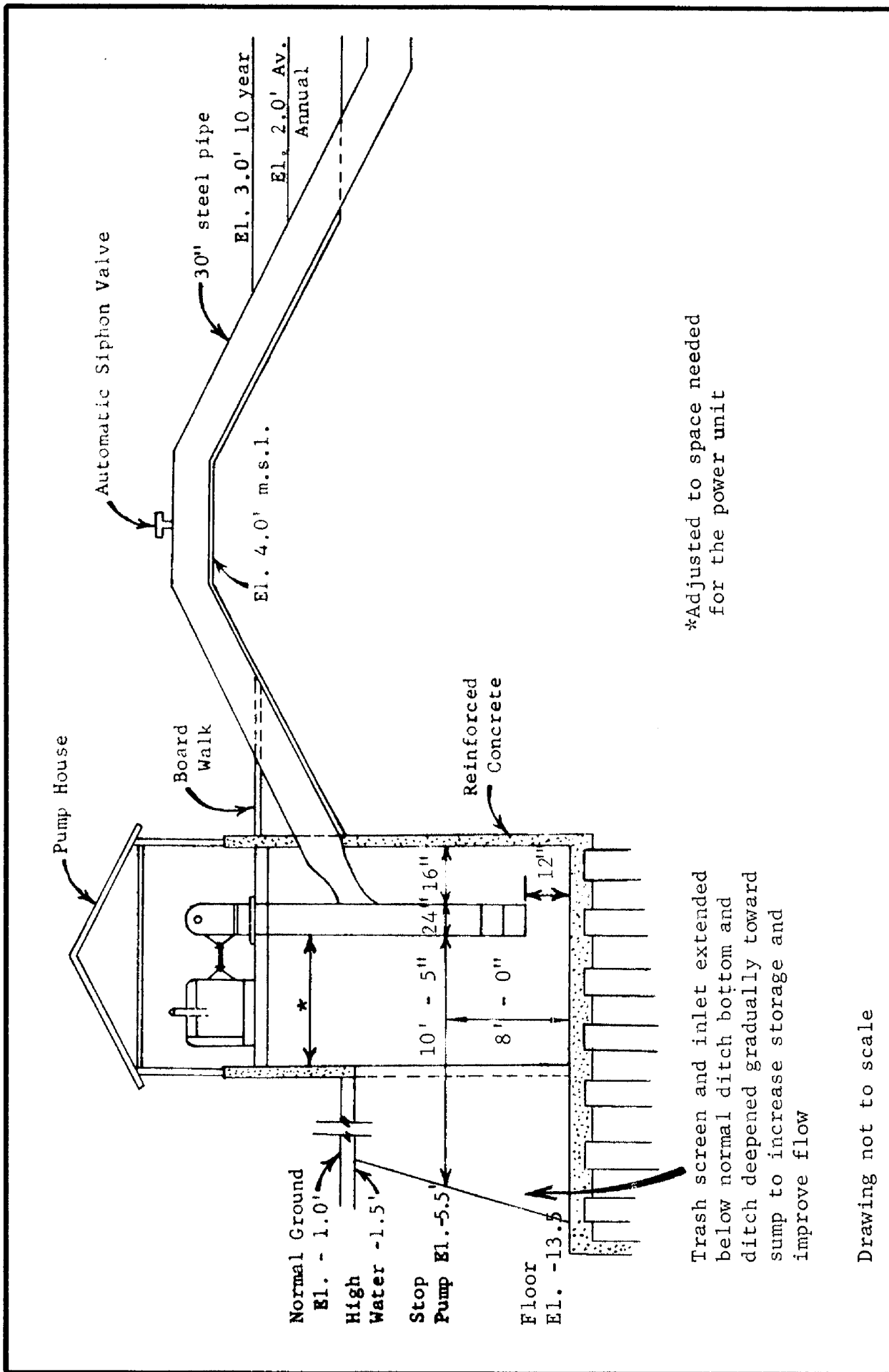

Figure 7B-2, Cross section of pumping plant layout

manufacturer's pump recommendations (figures 7B-3 and 7B-4), a propeller pump will be used. A 10 feet per second discharge velocity is used as in the range of efficient pump performance for a capacity of 11,436 GPM (equal to 25.5 cfs).

The required pump cross section area $A = \frac{Q}{V} = \frac{25.5}{10} = 2.55$ square feet

$$\begin{aligned} \text{The required pump diameter} &= \left(\frac{4A}{\pi} \right)^{1/2} = \left(\frac{4 \times 2.55}{3.1416} \right)^{1/2} \\ &= 1.8 \text{ ft.} = 21.6 \text{ in. or say 22 in.} \\ &\quad \text{(also see table 7-4)} \end{aligned}$$

A 24-inch diameter pump will be used as nearest manufactured size readily available.

Engine size

A gasoline engine with drive through gearbox will be used.

$$24\text{-inch pump velocity } (V_1) \text{ at design discharge} = \frac{Q}{A} = \frac{25.5}{3.1416} = 8.12 \text{ fps}$$

$$\text{Velocity head } (h_{V_1}) = \frac{V_1^2}{2g} = \frac{65.93}{64.4} = 1.02 \text{ (also see figure 7-6)}$$

Discharge pipe is to be enlarged from 24-inch diameter (d_1) at pump to 30-inch diameter (d_2) within distance of 2 feet. Loss in head (h_2) from gradual enlargement may be computed from formula 6-33 and values in table 6-8 of King and Brater Handbook of Hydraulics (9).

$$h_2 = K_2 \left(\frac{V_1^2}{2g} \right) = 0.09 \times 1.02 = 0.09 \text{ feet}$$

where:

$$V_1 = \text{velocity in smaller pipe} = 1.02$$

$$K_2 = \text{value from table} = 0.09 \text{ for } \frac{d_2}{d_1} = \frac{30}{24} = 1.25 \text{ and}$$

$$\text{angle of cone} = 14^\circ 20' \text{ (approx.)}$$

$$\tan 1/2 \text{ angle} = \frac{0.25}{2.0} = 0.125 \text{--} 1/2 \text{ angle} = 7^\circ 10' \text{ (approx.)}$$

Velocity at discharge (V_2) = $\frac{25.5}{4.9} = 5.2$ fps where cross section area of 30-inch steel pipe = 4.9 square feet

$$\text{Velocity head } (h_{V_2}) = \frac{V_2^2}{2g} = \frac{27.0}{64.4} = 0.42 \text{ foot}$$

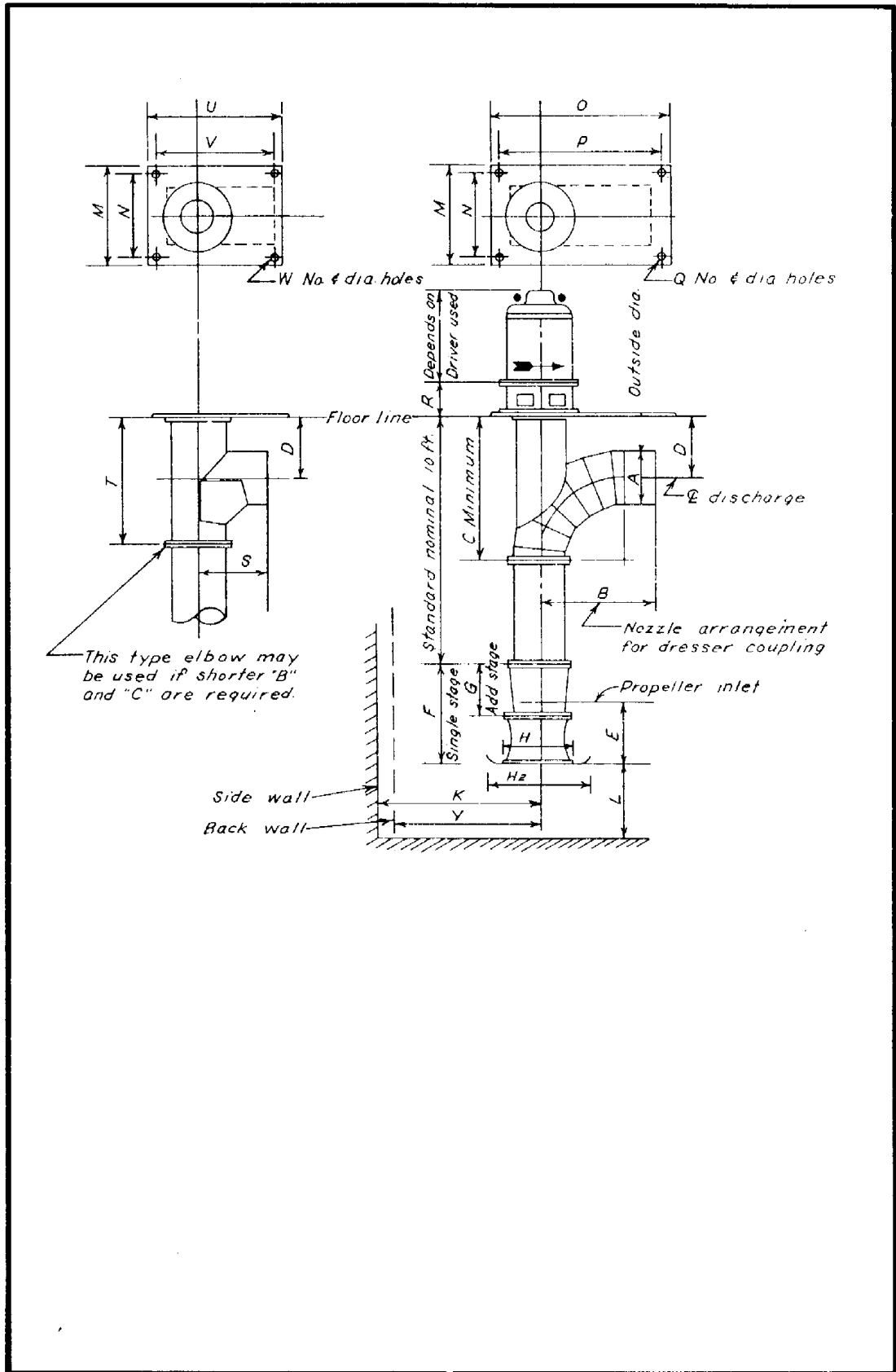

Figure 7B-3, Layout of principal dimensions - vertical axial flow pumps

PRINCIPAL DIMENSIONS IN INCHES (UNLESS OTHERWISE NOTED)

| SIZE OF PUMP | A | B | C | D | E | F | G | H | K | L | M | N | O | P | Q | R | S | T | U | V | W | H ₂ | Y |
|--------------|-----|--------|----------|-------|----------|----------|--------|--------|--------|----|---------|---------|---------|---------|------------|----|--------|--------|-------|--------|-----------|----------------|--------|
| 8 | 8 | 18 | 2'-6" | 18 | 6 1/4 | 13 | 8 | 12 3/4 | 15 | 5 | 20 | 16 | 2'-6" | 2'-6" | 4 (7/8) | 8 | 14 | 2'-2" | 2'-2" | 22 | 4 (7/8) | 24 | 11 |
| 10 | 10 | 21 | 2'-9" | 18 | 8 1/4 | 16 1/4 | 9 1/4 | 15 1/2 | 18 | 6 | 24 | 20 | 2'-10" | 2'-6" | 4 (7/8) | 8 | 15 | 2'-3" | 2'-4" | 24 | 4 (7/8) | 30 | 13 |
| 12 | 12 | 24 | 3'-0" | 18 | 9 3/4 | 19 | 10 3/4 | 18 | 21 | 7 | 2'-2" | 22 | 3'-2" | 2'-10" | 4 (1) | 8 | 17 | 2'-5" | 2'-7" | 2'-3" | 4 (1) | 35 | 14 |
| 14 | 14 | 2'-5" | 3'-9" | 24 | 10 | 21 | 12 1/2 | 21 | 24 | 8 | 2'-6" | 2'-2" | 3'-6" | 3'-2" | 4 (1) | 8 | 18 | 3'-0" | 2'-9" | 2'-5" | 4 (1) | 42 | 1'-3" |
| 16 | 16 | 2'-6" | 4'-0" | 24 | 12 | 2'-0 1/2 | 14 1/4 | 25 | 2'-6" | 9 | 3'-0" | 2'-6" | 4'-0" | 3'-6" | 4 (1) | 8 | 20 | 3'-2" | 3'-2" | 2'-8" | 4 (1) | 46 | 1'-5" |
| 18 | 18 | 2'-11" | 4'-3" | 24 | 12 | 2'-3 1/2 | 15 | 28 | 2'-9" | 10 | 3'-2" | 2'-8" | 4'-6" | 4'-0" | 4 (1 1/8) | 8 | 22 | 3'-4" | 3'-5" | 2'-11" | 4 (1) | 48 | 1'-7" |
| 20 | 20 | 3'-2" | 4'-6" | 24 | 15 1/2 | 2'-6 1/2 | 16 1/2 | 32 | 3'-0" | 11 | 3'-6" | 3'-0" | 4'-10" | 4'-4" | 4 (1 1/8) | 8 | 24 | 3'-6" | 3'-8" | 3'-2" | 4 (1) | 54 | 1'-9" |
| 24 | 24 | 3'-8" | 5'-6" | 2'-6" | 19 | 3'-2" | 19 1/2 | 36 | 3'-6" | 12 | 3'-10" | 3'-4" | 5'-6" | 5'-0" | 4 (1 1/4) | 8 | 2'-3" | 4'-3" | 4'-1" | 3'-7" | 4 (1 1/8) | 60 | 1'-11" |
| 30 | 30 | 4'-5" | 6'-3" | 2'-6" | 21 1/2 | 4'-0" | 2'-1" | 42 | 4'-0" | 15 | 4'-4" | 3'-10" | 6'-6" | 6'-0" | 6 (1 1/4) | 8 | 2'-8" | 4'-8" | 4'-9" | 4'-3" | 4 (1 1/8) | 72 | 2'-0" |
| 36 | 36 | 5'-2" | 7'-6" | 3'-0" | 23 | 4'-6" | — | 54 | 5'-0" | 18 | 5'-4" | 4'-10" | 7'-6" | 7'-0" | 6 (1 1/4) | 8 | 3'-0" | 5'-6" | 5'-4" | 4'-10" | 4 (1 1/4) | 84 | 2'-6" |
| 42 | 42 | 5'-11" | 8'-3" | 3'-0" | 2'-3 1/2 | 5'-1" | — | 64 | 6'-0" | 22 | 6'-3" | 5'-9" | 8'-6" | 8'-0" | 8 (1 1/4) | 12 | 3'-4" | 5'-10" | 6'-3" | 5'-9" | 8 (1 1/4) | 96 | 3'-0" |
| 48 | 48 | 6'-3" | 9'-0" | 3'-0" | 2'-7 1/2 | 5'-11" | — | 74 1/2 | 7'-0" | 25 | 7'-2" | 6'-8" | 9'-6" | 9'-0" | 8 (1 1/4) | 12 | 3'-10" | 6'-2" | 7'-2" | 6'-8" | 8 (1 1/4) | 112 | 4'-3" |
| 54 | 54 | 6'-9" | 9'-1 1/2 | 3'-6" | 2'-11" | 6'-8 1/2 | — | 85 1/2 | 8'-0" | 29 | 8'-2" | 7'-8" | 9'-6" | 9'-0" | 8 (1 1/4) | 12 | 4'-4" | 7'-2" | 8'-2" | 7'-8" | 8 (1 1/4) | 128 | 4'-6" |
| 60 | 60 | 6'-9" | 10'-3" | 4'-0" | 3'-3" | 7'-7 1/2 | — | 96 | 9'-0" | 33 | 9'-0" | 8'-6" | 10'-3" | 9'-9" | 8 (1 1/2) | 12 | 4'-10" | 8'-2" | 9'-0" | 8'-6" | 8 (1 1/2) | 144 | 4'-9" |
| 72 | 72 | 6'-6" | 10'-6" | 4'-6" | 3'-4" | 8'-3" | — | 115 | 10'-9" | 39 | 10'-6" | 10'-0" | 10'-6" | 10'-0" | 16 (1 1/2) | 18 | — | — | — | — | — | 172 | 5'-0" |
| 84 | 84 | 7'-6" | 12'-0" | 5'-0" | 3'-10" | 9'-8" | — | 134 | 12'-6" | 45 | 12'-4" | 11'-10" | 12'-4" | 11'-10" | 16 (1 1/2) | 18 | — | — | — | — | — | 201 | 6'-0" |
| 96 | 96 | 8'-6" | 13'-6" | 5'-6" | 4'-4" | 11'-0" | — | 154 | 14'-0" | 51 | 13'-10" | 13'-4" | 13'-10" | 13'-4" | 16 (1 1/2) | 18 | — | — | — | — | — | 231 | 6'-6" |
| 120 | 120 | 10'-6" | 16'-6" | 6'-6" | 4'-9" | 13'-6" | — | 189 | 16'-0" | 63 | 16'-9" | 16'-3" | 16'-9" | 16'-3" | 14 (1 1/2) | 24 | — | — | — | — | — | 283 | 8'-4" |
| 144 | 144 | 12'-6" | 19'-6" | 7'-6" | 5'-9" | 16'-9" | — | 234 | 20'-0" | 75 | 20'-6" | 20'-0" | 20'-6" | 20'-0" | 16 (1 1/2) | 24 | — | — | — | — | — | 351 | 10'-3" |

*Split base plate.

†"K"=distance from pump vertical center line to side wall.

"2K"=distance between the vertical center lines of 2 pumps with out separating wall.

"Y"=distance from pump vertical center line to back wall but should be increased to H₂/2 when increased bell diameter (umbrella) is used.

Figure 7B-4, Table of principal dimensions - vertical axial flow pumps

Friction loss in 44 feet of 30-inch steel pipe over the dike using Manning equation, formula 6-26c King and Brater Handbook of Hydraulics (9) (also see figure 7-6) equals

$$h_f = \frac{2.87 n^2 \ell V_2^2}{d^{4/3}} = \frac{2.87 \times (0.015)^2 \times 44 \times (5.2)^2}{(2.5)^{4/3}} = 0.23 \text{ ft.}$$

where:

h_f = head loss in feet

n = friction factor = 0.015

ℓ = length of pipe in feet = 44

V_2 = velocity in discharge pipe in fps = 5.2

d = diameter of pipe in feet = 2.5

Friction loss in bends (for long radii up to 45°) using formula 6-39 and figure 6-5 for 90° bends, and 25 percent reduction for 45° bends, from King and Brater Handbook of Hydraulics (9), loss in one 45° bend equals

$$\begin{aligned} h_b &= 0.75 K_b \left(\frac{V^2}{2g} \right) \\ &= 0.75 \times 0.20 \times 0.42 \\ &= 0.063 \text{ ft.} \end{aligned}$$

where the value of K_b in figure 6-5 for a bend radius (R) to pipe diameter (d) of $\frac{12.5}{2.5}$ or 5 is equal to 0.2.

Total h_d for 3 bends = 3 x 0.063 = 0.19 ft.

Total significant losses plus velocity head at discharge

$$\begin{aligned} &= h_2 + h_f + h_b + h_{V_2} \\ &= 0.09 + 0.23 + 0.19 + 0.42 = 0.93 \text{ ft.} \end{aligned}$$

Total head equals static head plus significant head losses plus velocity head

$$= 8.50 + 0.93 = 9.43 \text{ ft.}$$

Required power

Pending final selection of engine and pump, the following efficiencies are assumed in order to determine approximate engine size required: pump 70%, transmission 95%, and engine 70%.

Then required horsepower is

$$\begin{aligned} \text{BHP} &= \frac{\text{GPM} \times \text{Total Head}}{3,960 \times \text{Efficiency}} \\ &= \frac{11,436 \times 9.43}{3,960 \times 0.70 \times 0.95 \times 0.70} \\ &= \frac{107,841}{1,843} = 58.5 \end{aligned}$$

Use 60 horsepower engine.

Assuming the design specific speed of the pump in the required range of head and capacity of 17,500 (see figures 7-8 and 7-11 and the Hydraulic Institute Standards (1)), RPM of the pump at design capacity can be computed from equation 7-5 where

$$\begin{aligned} \text{RPM} &= \frac{\text{Specific Speed} \times (H)^{3/4}}{(\text{GPM})^{1/2}} \\ &= \frac{17,500 \times (9.43)^{3/4}}{(11,436)^{1/2}} = \frac{17,500 \times 5.4}{107} \\ &= 885 \end{aligned}$$

Using a standard heavy duty gasoline engine of an operating speed of 1,800 RPM, a 2 to 1 reduction gear transmission is required.

Sump dimensions

Using Hydraulic Institute recommendations (see figures 7-14 and 7-15) pending final design adjustments to meet manufacturer's requirements (see figures 7B-3 and 7B-4) of the selected pump, the following sump dimensions should be provided:

| | |
|---|------------|
| Bottom of pump bell to top of sump floor | 12 inches |
| Centerline of pump to backwall of sump | 28 inches |
| Centerline of pump to sidewall of sump | 32 inches |
| Sump floor below pump-stop level (El. -5.5) | 96 inches |
| Center of trash rack to back wall of sump | 165 inches |

Other dimensional requirements in determining final sump size (not covered herein) will include space necessary for housing the selected pump, power and transmission unit, weight against buoyant uplift, and flow entrance to limit velocity and provide capacity.

NATIONAL ENGINEERING HANDBOOK

SECTION 16

DRAINAGE OF AGRICULTURAL LAND

CHAPTER 8. DRAINAGE OF ORGANIC SOILS

| | <u>Contents</u> | <u>Page</u> |
|--|-----------------|-------------|
| General | | 8-1 |
| Classification of Organic Soils | | 8-1 |
| General properties of organic soils | | 8-1 |
| Mineral matter content | | 8-1 |
| Botanical composition | | 8-2 |
| Sedimentary peats and mucks | | 8-2 |
| Sedge peats and mucks | | 8-2 |
| Moss peats and mucks | | 8-2 |
| Woody peats and mucks | | 8-3 |
| Subsidence in Drained Organic Soils | | 8-3 |
| Causes of subsidence | | 8-3 |
| Allowance for subsidence in design | | 8-3 |
| Other Characteristics of Organic Soils and Their Treatment | | 8-4 |
| Erosiveness | | 8-4 |
| Combustibility | | 8-4 |
| Absorption and water-holding capacity | | 8-5 |
| Design Requirements for Ditches and Drains | | 8-5 |
| Mains and laterals | | 8-5 |
| Field ditches and drains | | 8-5 |
| Protection against overdrainage | | 8-6 |
| Mole drains | | 8-6 |
| Pump Drainage | | 8-6 |
| Dikes | | 8-6 |
| Controlled Drainage | | 8-7 |
| References | | 8-8 |

CHAPTER 8. DRAINAGE OF ORGANIC SOILS

General

General investigations, design, and development of drainage facilities for organic soils follow the same procedure used in draining mineral soils. However, modifications and adjustments must be made to meet properties and problems inherent with such soils. These include depth of formation, variations in drainage capacity, water-holding capacity, combustibility, erosion, shrinkage and swelling, subsidence, and availability of outlet. Appropriate design factors should be worked out in drainage guides.

High land values, coupled with small and intensively cultivated holdings, frequently complicate design of drainage systems for such soils by (a) necessitating the fitting of the drainage pattern to varied property boundaries, (b) limiting the open channel to the least possible land area, and (c) requiring flexible water controls to suit varying operations of many owners.

Classification of Organic SoilsGeneral properties of organic soils

Organic soils involved in drainage problems are those that are saturated with water for prolonged periods of time or have been artificially drained. Differences among such organic soils, commonly called peats and mucks, reflect their response to drainage. These differences, in turn, reflect variations in their character and origin. In the classification of organic soils, efforts have been made to indicate these differences.

The classification of organic soils followed in soil surveys of the U.S. Department of Agriculture and Land Grant Colleges is based on a number of soil properties. Major emphasis is given to the nature, arrangement and thickness of distinctive layers in the profile, mineral content, and stage of decay. Broad classes have been distinguished according to stage of decomposition as Fibric, Hemic, or Sapric. The Fibric are the least decomposed, the Sapric most decomposed, and the Hemic are in an intermediate stage of decomposition between the Fibric and Sapric. Peats are the least decomposed and mucks the most.

Classification of organic soils highly useful to the drainage specialist has been on the basis of mineral matter content, as ash residue from burning, and the botanical composition.

Mineral matter content

In the soil survey, organic soils are distinguished from mineral soils when the surface layer in its natural state has a thickness of 16 inches or more, and has either (a) 20 percent or greater organic matter content when the mineral fraction has little or no clay, (b) 30 percent or greater organic matter content when the mineral fraction has 50 percent or more clay, or

(c) an organic matter content that varies from 20 to 30 percent when the clay content of the mineral fraction ranges from 0 to 50 percent, respectively.

In land drainage, organic soils are classified by drainage specialists according to ignition loss. Peats are defined as containing 50 percent or more organic matter and mucks as containing less than 50 percent. Generally, mucks are preferred for agricultural use because they drain better, shrink less, work more easily, and need less fertilizer.

Some mineral surface soils are so high in organic matter that they behave somewhat like organic soils. Such soils usually are intermediate in character between the organic and mineral soils. However, in the soil survey they are classified in an appropriate series of mineral soils. An example is the Bayboro soils series which occurs along the Atlantic seaboard. Some members of this series so nearly approach the character of mucks or peats in the surface layers that one soil type has been called Bayboro mucky loam to distinguish it from Bayboro loam.

Botanical composition

Broad groups of organic soils are recognized on the basis of botanical composition. These groups are the sedimentary peats and mucks, sedge peats and mucks, moss peats and mucks, and woody peats and mucks. A detailed description of these groups is contained in USDA Bulletin 1419 by Dachnowski-Stokes (1).

Sedimentary peats and mucks. - Sedimentary peats and mucks consist of fine-textured, nonfibrous organic matter derived from aquatic vegetation in which are scattered remains of algae, plankton and pollen. Generally, these deposits are black or green, rather elastic, and highly colloidal. Normally accumulating in deep water, they also occur characteristically as deep layers, often in depressions with strongly sloping sides. Upon drying, these soils shrink, crack, and finally become hard. Once dry they absorb water very slowly. They lack stability and firmness under load and are expensive to drain. After being drained they are poor for crop production because of unfavorable physical properties and moisture relationships. Where sedimentary peats or mucks occur in the form of thin layers in a profile of coarser peats or mucks, they can often be broken up mechanically and mixed with the coarser materials.

Sedge peats and mucks. - Sedge peats and mucks are the residues from sedges, reeds, and grasslike plants of various sizes. Some residues also come from other plants so that these peats and mucks are commonly heterogeneous. They are generally porous, fibrous, and have a wide variety of sizes of plant remains. They decompose slowly and have less tendency to shrink and subside than do sedimentary or moss peats and mucks. They drain readily, are moderately fertile, and are generally good for agricultural use.

Moss peats and mucks. - Moss peats and mucks consist mostly of residues from sphagnum and hypnum mosses. They are spongy and fibrous though finer than sedge peats and mucks. Sphagnum peats are low in plant nutrients, strongly acid, and of little agricultural value. Hypnum peats are fairly dark in color, somewhat less acid, and better suited for crop production. Moss peats and mucks usually absorb water in amounts equaling 5 or 6 times their dry weight but may absorb as much as 20 times their dry weight. These soils are hard to drain, tend to shrink greatly as they dry out, and swell markedly when wet. If they are overdrained the organic residues pack poorly and the soil becomes droughty. Where layers of moss peat occur in profiles consisting

mainly of sedge or woody peat they retain moisture and retard movement of water toward outlets. Thus, they lead to uneven shrinkage if drains are widely spaced.

Woody peats and mucks. - Woody peats and mucks commonly consist of granular, well disintegrated residues of woody plants mixed with some wood fragments. The residues may come from deciduous or coniferous trees, from various shrubs such as heath, willow and alder, or from all of these plants. Vertical sections are relatively homogeneous as a rule though horizontal bands of slightly decayed residues may occur. These peats and mucks are less plastic and cohesive than the other three kinds. They are inclined to sloughing in the banks of deep drains. Water velocities need to be kept low in channels draining large areas. In general, woody peats and mucks have lower water-holding capacities than others and, therefore, drain more readily. Once drained and developed, they have relatively favorable physical properties and can be used successfully for crop production, especially for vegetables.

Subsidence in Drained Organic Soils

Causes of subsidence

Surface subsidence is the result of soil shrinkage by oxidation and compaction and direct soil loss by erosion and burning. Shrinkage is inevitable with drainage. Lowering of the water table permits entry of air into pores. Oxidation of the organic soil by action of aerobic bacteria converts such matter to carbon dioxide, which escapes into the atmosphere, and water. The removal of water by drainage causes weight of upper soil layers to compact lower layers. The operation of farming equipment in preparing and compacting seed-bed consolidates surface layers by pulverizing the soil and eliminating larger soil voids.

Observation of many sites over many years in both the United States and Europe indicates an overall average subsidence of about 1 inch per year and that this rate varies directly with the depth of organic material exposed above the water table. Higher initial rates of subsidence occur within the first several years after drainage. These higher rates are attributable primarily to initial compaction which may be two or three times the average subsidence occurring in later years.

Allowance for subsidence in design

Subsidence, with resulting drop in surface elevation, reduces the fall available for drainage into an available outlet. By nature of most sites where organic soils are formed, an outlet for free drainage discharge is limited in depth and grade. Unless pump drainage is provided, outlet improvements may need to be carried out long distances below the benefited area. Unequal settlement of only small areas can affect a whole field. Design of an adequate drainage system must allow for subsidence over a reasonable life expectancy of the improvement. Where no local data on subsidence rates are available, an allowance for initial subsidence of a newly developed site can be estimated as 25 to 35 percent of the designed depth of drains below the existing land level. At least 10 percent should be allowed for drains constructed or reconstructed on previously drained land. Information on subsidence rates for specific areas of the United States, which are useful in design, have been published by Sutton (2), Stephens (3), Roe (4), Jongedyk (5) and others.

In designing the mains and laterals, the best procedure is to prepare, first, a rough preliminary design without considering subsidence to determine the approximate location, size, and depth of ditches and drains. Next, consider existing ground elevations and corresponding soil borings to take subsidence into account. Estimated subsidence should be determined along each channel, based on the channel depths and borings of the preliminary design. Next, the estimated subsidence should be subtracted from existing ground elevations to determine elevations of a subsided surface. Then a final design hydraulic gradient should be established for the channels with respect to a point in the outlet channel well downstream and below the improvement, where subsidence should not take place. Channel sections should then be adjusted to this gradient to provide the depth and size necessary to discharge the design flow. In some situations, changes in surface elevation after subsidence may be enough to require a complete realignment or relocation of the main and laterals.

Other Characteristics of Organic Soils and Their Treatment

Erosiveness

Volume weight of organic soil, as compared to mineral soil, is low. Peats may contain as little as 8 to 20 pounds of dry material per cubic foot. When surface layers of peat and muck become pulverized by alternate wetting, drying, and working, they are easily moved by wind and water. Wind erosion usually is an important factor influencing organic soils. It damages young plants by abrasions and contributes to rapid silting of ditches. Susceptibility to wind erosion can be minimized by reducing surface exposure of land to the sweep of the wind. This is done by surface barriers, by vegetation and other treatment of the surface, and by maintaining as high water level in the soil as practicable, particularly in the nongrowing season.

Barriers may be fixed or movable, live or constructed materials. Effective live barriers can be plantings of green willow, Chinese elm, privet, or evergreens in rows 200 to 350 feet apart across the direction of prevailing wind. Deciduous plantings give earlier protection after planting but lack year-round protection of the slower growing evergreens. Snow fences, at close spacing, provide temporary removable barriers and occupy less cropland. Planning of barriers should be coordinated with the planning of the drainage system so that ditches are least affected by silt deposition and vegetative growth, and so that covered drains are protected from root intrusion. Interplantings of crops as rye or rows of corn and sunflower provide surface protection from wind. Intermixing fibrous and woody matter or clay as a binder in the soil surface also reduces hazard of both wind and water erosion but is costly.

Water erosion is most likely to occur when runoff from sloping land or steep uplands discharges into the area. Preventive measures should include: (a) Diversion of upland water at the outer edge of the development; (b) design and location of mains and laterals when serving large areas, so as to attain low velocities; (c) combining subsurface drains with regularly spaced ditches laid across slope, so as to break up overland water movement; and (d) use of drop structures for ditch overfalls into deeper outlet ditches or natural channels.

Combustibility

Mucks and peats burn readily when dry. Burning of tussocks, brush and timber during clearing for construction and land improvement should not be permitted except when the ground is saturated and fire can be controlled. To avoid risk of highly susceptible grass and brush fires, drainage of peat and muck land

should be deferred until ready for agriculture. Drainage systems should be designed, insofar as possible, to permit raising of the water table during dry seasons.

Absorption and water-holding capacity

Fibrous peats have high absorption and water-holding capacity. Excessive swelling when wet and poor compaction result in uneven surfaces that cause spotty areas of poor drainage or droughtiness. Construction of closely spaced drains and regulation of the water table are required to maintain uniform moisture control. Excessive drying of organic soil is dangerous in that the pasty secretion in the peaty aggregate rehydrates more slowly with decreasing water content, and, once dry, rehydration may be impossible. In organic soils overlaying marl, silty clay, clay, or fine non-water-bearing sand, an absorption cushion of organic soil should be left between the bottom of ditches and the impervious material to serve as a reservoir of moisture during drought. This cushion should be one foot thick and never less than one-half foot thick.

Design Requirements for Ditches and Drains

Mains and laterals

Main and lateral ditches should be designed to meet the general requirements of similar channels in mineral soils, with allowances for subsidence. Generally, in deep peats or moderately deep peats over open sands, mains may be spaced out as wide as 1,500 to 2,500 feet and laterals kept to possibly 500 to 600 feet. Side slopes in main and lateral ditches should not be steeper than 1 to 1. Such channels require as much width as necessary for hydraulic capacity, but bottom widths should not be less than 3 feet.

Field ditches and drains

Both ditches and subsurface drains can be used as field collectors in deep peat. However, installations of covered drains should not be considered in new drainage developments until 3 or more years after initial settlement has taken place, and then only after careful investigations show that a uniform bearing and an adequate outlet can be assured for the drains throughout.

Because of variation in moisture-holding capacity and other local properties of organic soil, depths and spacing of drains vary greatly and should be established in drainage guides. Depth of covered drains should be at least 4 feet after initial settlement takes place. Lines should be spaced from approximately 50 to 200 feet apart, depending on the density of the materials. The woody and grass reed peats usually drain well at about 100- to 120-foot spacings. Closer spacings are best where controlled drainage will be used. If in doubt, the wider spacings can be tried and supplemental lines interspaced later if necessary. Where covered drains are installed on a large block of land, some ditches should be left for surface water removal during flash floods.

When the depth of organic soil to the underlying mineral soil is less than 4 feet, covered drains can still be used if they can be supported continuously in the mineral soil. Drains should not be laid with support alternating in nonyielding mineral and yielding organic soils. Backfill over a drain in clay subsoil should be pervious material.

When the depth of the organic material is less than 3 feet, ditches should be used. When organic soil is situated over marl, clay or silty clay, the depth of ditch should be adjusted to provide an organic cushion of at least 1/2- to 1-foot depth beneath the bottom of the open ditch. Spacings between drains should be decreased to correspond to such lesser depths, usually 60 to 100 feet for 2-foot depths and up to 200 feet for 3-foot depths.

Field ditches can be dug using almost vertical side walls for fibrous peats. Side slopes of at least 1/2 to 1 should be used on the less stable woody peats. Side slopes of 1/4 to 1 are commonly used for field ditches.

The required capacities of covered drains are about twice those for mineral soils, so that coefficients should be about 1/2 to 3/4 of an inch in 24 hours for general field crops and 3/4 to 1 1/2 inches for truck crops.

Protection against overdrainage

When seepage or low waterflow is likely to be insufficient during drought, some water control by temporary dikes or by structures should be provided for protection against overdrainage. When an added source of water is imperative, wells, diversions or storage for irrigation may be considered.

Mole drains

Mole drains have been used successfully for subsurface drainage in Florida when drawn through fibrous organic soil. The usual depth is about 30 inches, spaced 12 to 15 feet apart. An approximate 4 1/2-inch diameter hole is obtained from a 6-inch mole. Best results are realized when the water level is kept below the mole line during construction. Use of occasional pipe vents as in regular subsurface drainage installations, placed while the lines are being drawn, prevents suction and consequent collapse of the mole hole. In Florida, moles last from 5 to 8 years.

Pump Drainage

Because of limited outlet or encroachment of swamps as subsidence progresses, pumping and diking are required on many projects. (See chapters 6 and 7.) Required heads to be pumped are low, mostly ranging from 4 to 8 feet. Low cost of recent-type propeller pumps has greatly implemented pumping of small areas and also has made possible reclamation of many others without gravity outlet.

While pumping plant design procedures are the same as those for mineral soils, higher drainage coefficients usually are needed for organic soils because of small areas and the high value of crops involved.

Dikes

Organic soils make poor dike material and should not be considered for permanent engineering structures. Fibrous peats are entirely unsatisfactory for dikes unless mixed with mineral soils, as is done in the cranberry areas of New England. Cost of construction is usually quite high in such cases. If mucks or the heavier peats are to be used, several precautions must be taken. The surface should be covered with 4 to 6 inches of sand whenever this is possible, and then kept grassed to protect from overdrying. At least 50 percent shrinkage can be expected and must be allowed for in the first year or two. The dike should then be retopped.

A minimum section with at least 1 to 1 side slopes and 8-foot minimum top should be provided. Surface materials should be removed from the base before construction. Where the dike must protect against a standing head of water during floods, the borrow pits should be kept on the outside of the dike. Safe heads may vary with peat or muck but should not exceed 4 feet. If only low heads occur outside of the dike (1 foot or less), the borrow may be taken from the protected landside. This channel then may serve as a seepage and drainage ditch. Permanent dikes constructed of organic soils should not be recommended by SCS engineers.



Controlled drainage in organic soils near Sebring, Florida

Controlled Drainage

Controlled drainage slows down subsidence and its adverse effect on the drainage system, reduces wind and fire loss, and reduces adverse effect of a fluctuating water table on crop yields. Controlled drainage permits irrigation without hindering field operations, has low labor and maintenance cost, and usually makes use of existing drainage systems with the controls as the only added installation. On the other hand, cost of closely-spaced drains for adequate irrigation, need for larger quantities of water than for overhead irrigation, and raising of undesirable salts in some localities are undesirable features. Controlled drainage is obtained by designing the system so that the water table can be maintained more or less constant at more effective depths throughout the year. Where pumps are used, control is obtained by means of the pump. It is also accomplished under gravity control

with dams or drop structures, usually of the flashboard or stoplog type. Installing dams in laterals rather than mains has the advantage of varying regulation for different fields and ownerships. Use of moles and closely-spaced subsurface drains provides more uniform control. During droughts, proper operation requires an adequate water supply from seepage or springs, or from surface supplies or wells obtained by pumping.

The water table, when controlled, can be maintained at higher levels than under free drainage. Maximum levels should be slightly below the zone of dense rooting and usually 18 inches for most grasses and shallow-rooted vegetables, 24 inches for most vegetables, and about 30 inches for deep-rooted crops as corn. The water table should be kept high in the spring to reduce wind erosion and lowered as the root system develops during the season. Adequate control requires continuous checks of water table levels, made through small observation wells located over various parts of the controlled area.

Adjustments in the rate of water removal for rainfall, etc., can be determined with reasonable accuracy. These are based on measurement of average voids in each foot of depth. Roughly, an inch of added water may provide as much as 1-foot rise in a 2- to 2 1/2-foot soil profile above the water table. Absorption and plant transpiration generally eliminate the effect of intermittent rainfalls of 1/2 inch or less.

References

- (1) DACHNOWSKI-STOKES, ALFRED P.
1926. Factors and Problems in the Selection of Peat Lands for Different Uses. U.S. Dept. Agr. Bul. 1419.
- (2) SUTTON, JOHN G.
1963. Water Management of Organic Soils. Transactions of 5th Congress, International Commission on Irrigation and Drainage.
- (3) STEPHENS, JOHN C.
1955. Subsidence of Organic Soils in the Upper Everglade Region of Florida. U.S. Dept. Agr. Yearbook 1955.
- (4) ROE, H. B.
1943. The Soil Moisture and Cropping Problem on Peat and Muck Lands in the Northern United States. (Scientific Paper 2032, Ag. Exp. Station, University of Minnesota) USDA, Soil Conservation Service, Milwaukee, Wis.
- (5) JONGEDYK, H. A., et al.
1950. Subsidence of Muck in Northern Indiana. Purdue University Ag. Exp. Station Circular 366.

NATIONAL ENGINEERING HANDBOOK

SECTION 16

DRAINAGE OF AGRICULTURAL LAND

CHAPTER 9. DRAINAGE OF TIDAL LANDS

| <u>Contents</u> | <u>Page</u> |
|---|-------------|
| General | 9-1 |
| Action of tides | 9-2 |
| Tidal terms and definitions | 9-2 |
| Tidal phenomenon | 9-3 |
| Tide curves | 9-3 |
| Determination of Local Tide Data | 9-6 |
| Site Investigations and Surveys | 9-7 |
| Topographic surveys | 9-7 |
| Subsurface investigations | 9-9 |
| Design Data | 9-9 |
| Design Procedure and Example | 9-11 |
| Tide gate capacity and size | 9-12 |
| Supplemental Pumping | 9-19 |
| Pumping requirement | 9-23 |
| Construction and Installation | 9-24 |
| Forebay channel section | 9-24 |
| Discharge bay channel section | 9-24 |
| Tide gates, pipes and outlet structures | 9-25 |
| Supplemental pump installations | 9-26 |
| References | 9-29 |

Figures

| | |
|---|------|
| Fig. 9-1, Typical ocean tide on open coastline | 9-4 |
| Fig. 9-2, Typical estuary tides | 9-4 |
| Fig. 9-3, Theoretical tide curves | 9-5 |
| Fig. 9-4, Tide curve | 9-8 |
| Fig. 9-5, Stage-storage curve | 9-10 |
| Fig. 9-6, Curves for tide gate discharge | 9-15 |
| Fig. 9-6a, Curves for tide gate discharge | 9-17 |
| Fig. 9-7, Sketches of tide and gate structure showing the stage sequence versus time | 9-20 |
| Fig. 9-7a, Sketches of tide and gate structure showing the stage sequence versus time | 9-21 |
| Fig. 9-7b, Sketches of tide and gate structure showing the stage sequence versus time | 9-22 |
| Fig. 9-8, Drainage flap-gate installation | 9-27 |
| Fig. 9-9, Typical low-head tide gate | 9-28 |

TablesPage

| | |
|--|------|
| Table 9-1, Field observations - tide cycle | 9- 7 |
| Table 9-2, Tide gate data sheet | 9-14 |
| Table 9-3, Tide gate data sheet | 9-25 |

CHAPTER 9. DRAINAGE OF TIDAL LANDS

General

This chapter discusses the phenomenon of tides and their effect on agricultural land, and it suggests remedial measures to protect these lands. It presents a procedure for the design of gravity operated tide gates, giving consideration to tidal cycles and fluctuations, anticipated interior drainage flows, and the interior storage available. A more detailed and precise procedure for the design of tide gates is given in Technical Release No. 1, Engineering Division, SCS (1); however, the simpler procedure outlined in this handbook is considered adequate for small to medium sized drainage projects planned for the protection of agricultural lands. The charts, tables and the example presented in this chapter are based on the use of circular-metal tide gates attached to corrugated-metal pipe, as these are commonly used structural materials. For protection against corrosion from salt water, it is necessary for the corrugated-metal pipe to be asbestos bonded and asphalt coated. Design data and criteria, for other types of gates and pipe, are available in handbooks prepared by a number of commercial concerns. It is presumed that pumps, where suggested as supplemental facilities in lieu of available storage, will be selected on the basis of manufacturer's specifications.

Agricultural lands in coastal areas, located along rivers, estuaries, bays and the open sea, are subjected in varying degrees to overflow and restricted drainage caused by tidal waters. These areas may range from a few acres to thousands of acres. The extent and frequency of overflow and drainage impairment may vary widely, depending on the elevation and exposure of the sites to open tidal water. Protection from overflow usually is obtained by the enclosure of such areas with dikes. Drainage may be obtained by establishing a system of internal drains, with water discharged over the dikes by pumps, by gravity flow through gated structures, or by a combination of pumps and gated structures.

Pumps are necessary when: (a) storage for accumulating drainage water within ponding areas, ditches, and the soil profile is not available; (b) when flow through the gates is restricted over long periods by wind tides, flood flow, or inadequate outlets into open tidal waters; or (c) when construction and maintenance of foreshore channels is impractical.

A gravity-outlet ditch with a gated structure through a protecting dike, provides suitable means for removing drainage waters from most tidal areas. A gated structure consists of a box or pipe culvert through the dike with a gate placed at the tidewater end of the structure. These gates may be circular, square, or rectangular in shape. Usually they are made of cast iron and provided with single or double acting hinges at the top. Well-made gates, when properly installed, are so finely balanced that they automatically open to outflow or close against backflow at slight differences in head. Large drainage areas may require several gated structures or a battery of culverts and gates incorporated in one structure.

Action of tides

The action of tides is a complex phenomenon, some general knowledge of which is essential to the planning and construction of any works affected by them. Only a few essential facts will be discussed herein. More detailed information is available in publications of the United States Coast and Geodetic Survey, including its annual tide tables for both coasts of North and South America; and the U.S. Army Engineers Waterways Experiment Station. See references (2) and (3).

Tidal terms and definitions

The tide is the regular periodic rise and fall of the surface of the oceans. Concurrent horizontal movements of surface waters as the result of tide-producing forces, occurring either as drifts in the open ocean or as flow through entrances to tidal basins and in tidal streams are known as tidal currents. The component of the tide produced by harmonic action of tide-producing forces is referred to as the equilibrium tide. The irregular fluctuations of the tide caused by winds and variations in barometric pressure over water surfaces are referred to as the meteorologic tides.

The path of a point at a particular station which traces the water surface elevation against time through a lunar or tidal period is the tidal curve for that station. The maximum elevation or crest reached by the rising limb of the tidal cycle (flood tide) is called the high water. The maximum depression or trough reached by the falling limb (ebb tide) is called the low water. The average height of all low waters at a station over a period of time is the mean low water. Similarly, the average height of all high water at a station over a period of time is the mean high water. The difference in height between high water and low water is the tidal range. The mean tidal range is the average of differences between all high waters and all low waters. The extreme range is the maximum that has been observed.

Because of variation in density of ocean water with changes in temperature, salinity and barometric pressure, and because of differences in wind and rain from place to place, mean sea level at different tidal stations may not be on the same geodetic level surface. Mean sea level, thus, is an actual mean of sea levels determined from a long series of tidal observations taken over a number of selected points. The plane of zero reference for tidal data in the United States is established by the Coast and Geodetic Survey from which local points of reference, called datum, are established. For the Atlantic and Gulf coast the datum is mean low water. For the Pacific coast (including Hawaii and Alaska) the datum is the mean of the lower of the two daily low waters. Local points of reference for several Atlantic and Gulf coast points as given in tide tables published by the U.S. Coast and Geodetic Survey are: -4.9 at Boston, -2.3 at New York, -3.1 at Philadelphia, -0.6 at Baltimore, -1.3 at Hampton Roads, -2.7 at Charleston, -1.3 at Miami, and -0.8 at Mobile, Alabama and Galveston, Texas. Local points of reference for several Pacific coastal points are: -6.6 at Seattle, -3.0 at San Francisco, -2.8 at Los Angeles, and -2.9 at San Diego.

When using tide tables, the relation of the datum on which the tables are based to the datum on which topographic maps and bench marks being used are based, should be considered. For specific situations, tidal records of the nearest Coast and Geodetic Survey or Corps of Engineers gaging station should be consulted.

Tides may be diurnal, semi-diurnal, or mixed. Tides with but one high and low each lunar day are diurnal. Diurnal tides occur over the greater part of each month along coastal areas of the Gulf of Mexico. Semi-diurnal tides have two nearly equal high waters and two nearly equal low waters each lunar day. Such tides are common to most coastal waters of the world and are the type occurring along the Atlantic and Pacific coasts. Since the differences between the two high waters and between the two low waters on the Atlantic coast are relatively small (generally less than one foot), no distinction is made between daily high waters or between daily low waters. Mixed tides are those which have two quite unequal high waters, two unequal low waters, or both during the course of a lunar day. Mixed tides occur on both the Pacific coast of the United States and the Atlantic coast in Europe.

The highs of high waters and lows of low waters also vary from day to day during the course of a lunar month and during the course of a solar year. The highest high waters and lowest low waters during the course of a lunar cycle occur shortly after full and new moons and are known as springs. Lowest high waters and highest low waters occur shortly after the first quarters and third quarters of the moon and are known as neaps. Springs and neaps change progressively from month to month, usually being highest near the spring and autumn equinoxes and lowest near the summer and winter solstices. Along the Atlantic seaboard, the swings produced by such springs and neaps are not sufficiently large to warrant their special consideration in determining the normal tidal ranges necessary in design of drainage outlets. However, when extremes occur concurrently with storm tides, their effects are significant in considering extreme tides for dike heights.

Tidal phenomenon

Tides are the result of a number of complex forces acting upon the earth's mass. The dominant component of these forces is the equilibrium tide, which develops from the gravitational attraction between earth, moon, and sun; and the constant harmonic changes in such pulls over the surfaces of the oceans and seas as the result of the rotation of the moon in its orbit about the earth and the spinning earth in its orbit about the sun. The range of the equilibrium tides differs from place to place. Along the coastlines of the United States, such variations range from a fraction of a foot in Gulf coast waters to 40 feet in the Bay of Fundy and Alaska.

The changing effect of lunar and solar pulls during the course of their travel cancel out or augment each other progressively during the months and year. This results in the gradual tidal swings which may be as much as 2 to 10 feet in some part of the earth's waters. Such swings are comparatively small along tidal waters of the Atlantic coast. Figures 9-1 and 9-2 illustrate some characteristic tides.

Tide curves

The theoretical oscillations of tides in the open ocean and coastal waters conform to the mathematical cosine curve. See Figure 9-3 for theoretical curves for various ranges of tide. Bays and sounds affect such undulations primarily by delaying the times of high and low water occurrence. Size, shape and alignment of coastal indentations may also decrease the net tidal swings. River estuaries affect the tide in varying degree, depending upon the size of the river, its hydraulic gradient and stage of river discharge. Their most characteristic effect on the tidal curve is to prolong the ebb tide. At low stages, water may flow up rivers in conformance to the open

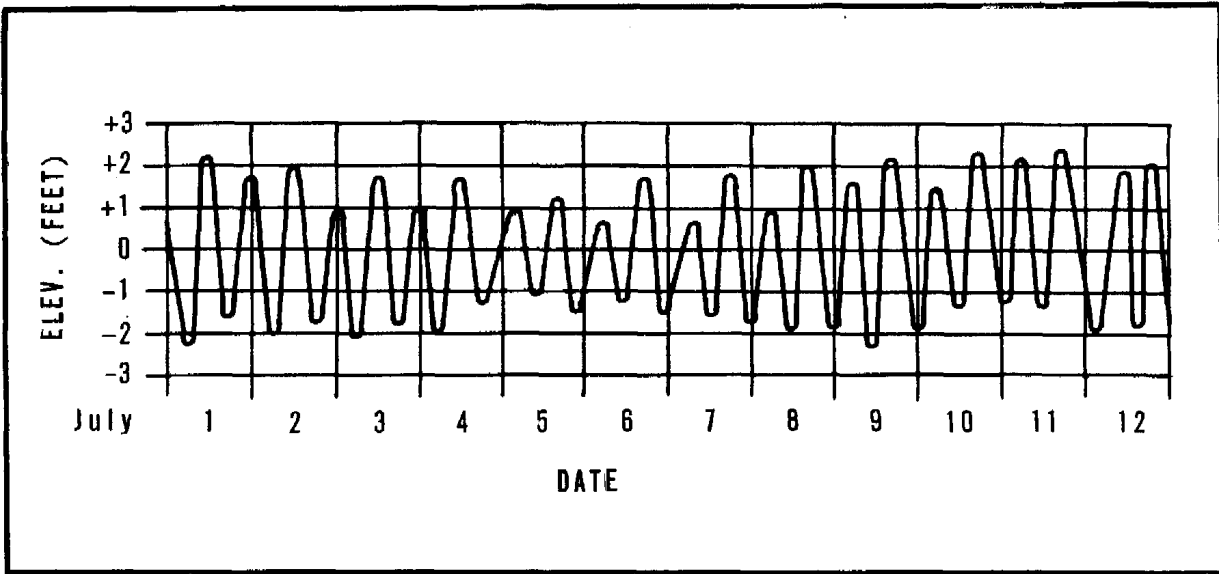

Figure 9-1, Typical ocean tide on open coastline

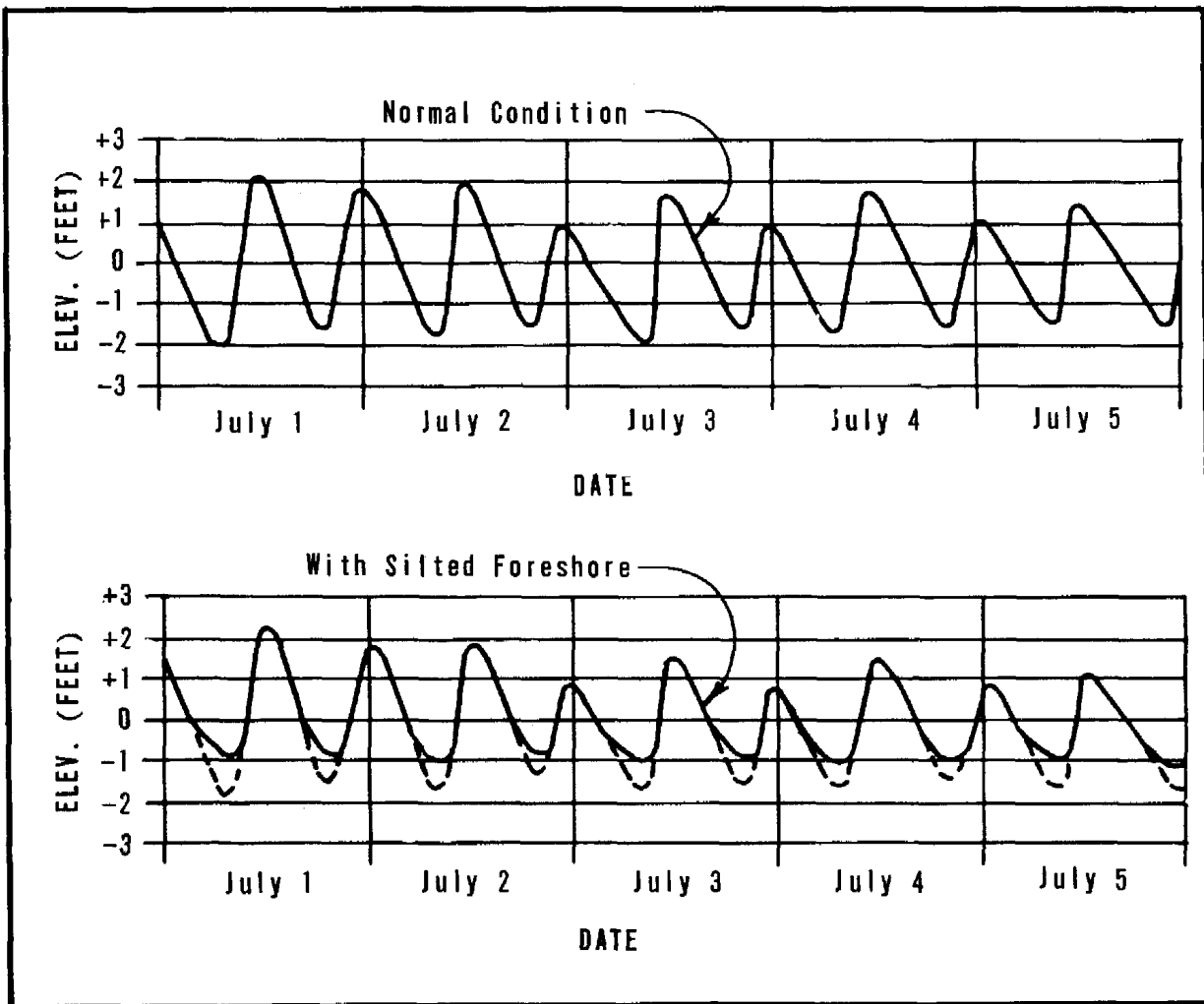

Figure 9-2, Typical estuary tides

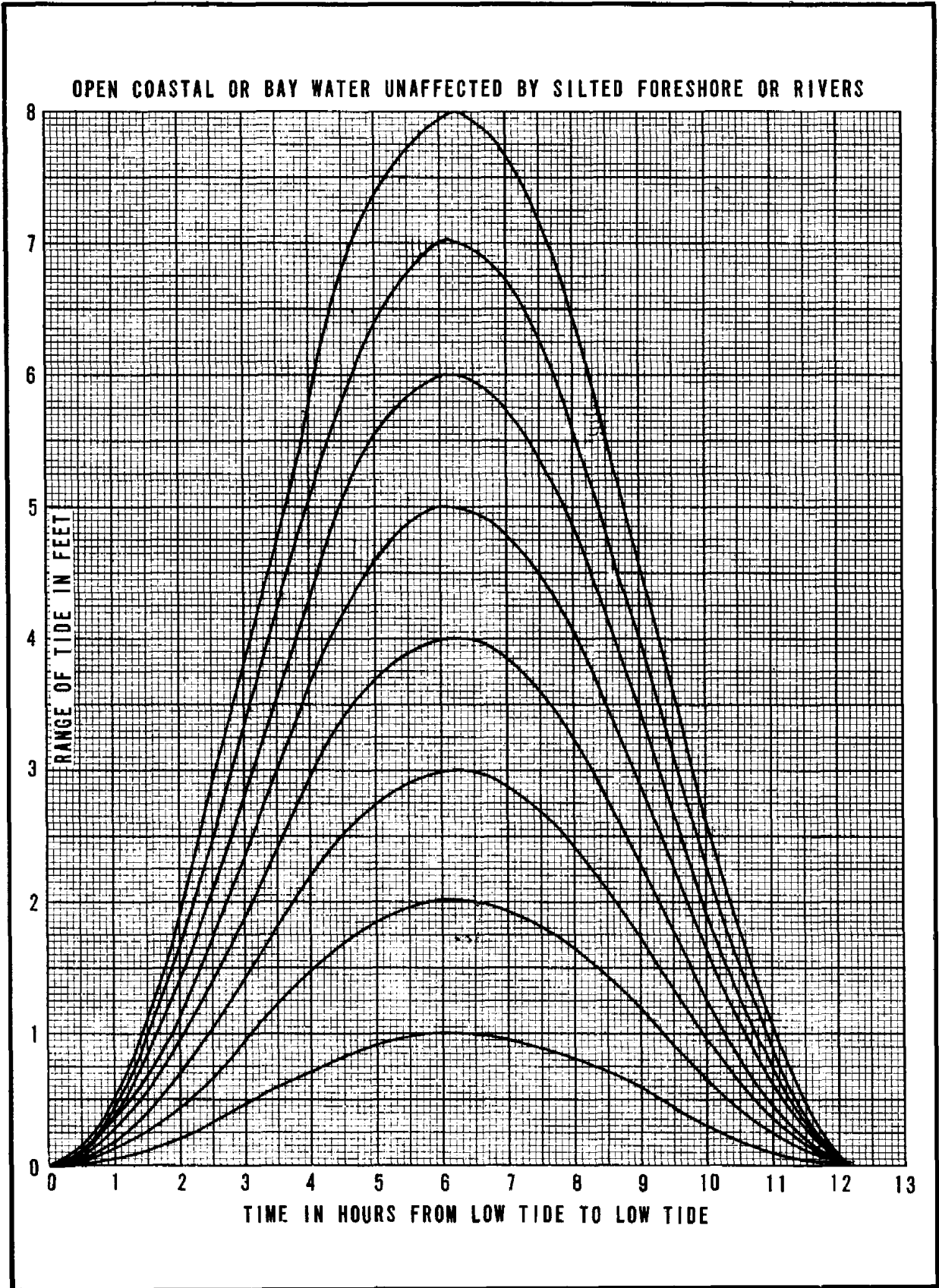

Figure 9-3, Theoretical tide curves

water tide curves. As river flow increases, tide swings become less and less. At high flood stages, effects of tides may be obliterated only a few miles upstream. Silted foreshores affect the water level oscillations by limiting the low elevations to which water might fall. The effect is on the low tide, whereas high tides tend to pour over deposits and rise to about the same elevation as if no silt deposits were present.

Determination of Local Tide Data

Tide data is best determined by direct observation at the site. Staff and automatic gages are used for this purpose. The staff gage is essentially a graduated board, set vertically at the edge of tidal water so that height can be read by an observer. Markings on the staff are usually graduated in feet and tenths for ease in reading at a distance. The automatic gage may be either of the float or bulb type that records the elevations on a reduced scale on clock driven charts.

A staff gage should be installed along with automatic gages to provide a means of checking and calibrating the automatic gages when necessary. The bulb-type gage usually is less accurate than the float-type gage; however, the bulb gage is sufficiently accurate for obtaining drainage design data and is quite desirable because of the ease with which it can be installed and removed for short-period setups at isolated sites. Gages should be referenced to accurate bench marks that are protected against damage or destruction. For convenience, gages should be set with their zeros on established local datum. Staff gage readings should be recorded over several tidal cycles. Where automatic gages are used, records should be obtained over a lunar month if possible. Readings should be taken when slight or no winds occur, or over long periods so that the effects of wind can be evaluated.

Onsite data should be correlated with the nearest local gages and records, which are often local port or harbor data. These not only provide a means of evaluating minor local effects, but make it possible to project to the site the major fluctuations caused by wind tides or river floods from long-time records of other gages. Adequacy of local records may vary, but good sources are usually available from nearby operating stations of the Corps of Engineers, Coast Guard and Coast and Geodetic Survey. Municipalities and harbor and port authorities often have complete and accurate records. Information on extreme high water can often be traced to local events recorded in old newspapers or community records or through inquiries of local residents. If the elevation of either or both low and high waters and tidal ranges are known, and effects of local distortions to the flood or ebb tide are insignificant, a reasonably accurate site curve can often be selected from the theoretical curves shown in Figure 9-3. Table 9-1 illustrates the record for an observed semi-diurnal tidal cycle obtained by an observer from watch and staff-gage readings taken at hourly intervals. This data plotted on Figure 9-4, shows the resulting tidal curve.

For reasons which will be explained later in the text, the tide data should be observed for two or three hours past the second high water stage of the first cycle. This enables plotting the elevation at which the tide gate will open in the second cycle.

Table 9-1, Field observations - tide cycle

| | Time (hours & minutes) | Gage Height (feet) | : | Time (hours & minutes) | Gage Height (feet) |
|----|---------------------------|--------------------------|---|---------------------------|--------------------------|
| AM | 6:30 | 3.3 | : | PM 3:30 | -0.9 |
| | 7:25 | 3.7 | : | 4:25 | 0.0 |
| | 8:30 | 3.4 | : | 5:32 | 1.5 |
| | 9:34 | 2.0 | : | 6:30 | 3.0 |
| | 10:28 | 0.9 | : | 7:35 | 3.7 |
| | 11:30 | -0.4 | : | 8:30 | 3.6 |
| PM | 12:28 | -1.5 | : | 9:25 | 3.0 |
| | 1:30 | -1.7 | : | 10:30 | 1.6 |
| | 2:32 | -1.5 | : | | |

Site Investigations and Surveys

Tidal lands subject to impairment due to their relatively low position with respect to the ocean are subject to many complicated situations. It is not the intent of this handbook to attempt to cover all of these situations, but rather to cover the common or usual situation. This is where low lying lands in coastal areas are wet because drainage from interior land areas is temporarily blocked by high tides and does not have free outlet to the ocean except during periods of low tide. During periods of high tide, which occur twice daily in most coastal areas, drainage water from the interior land area is ponded in drainage channels and adjacent low areas, including low lying croplands. This ponded water may be fresh water, salty water or a mixture of the two, depending on the relative hydraulic gradient between the ocean and the ponded drainage water. Usually it is some mixture of the two. The basic purpose of drainage in these areas is to prevent sea water from moving into these areas during high tide and to provide for disposal of the accumulated fresh water from interior drainage during periods of low tide.

A system to accomplish this purpose is one utilizing a dike with automatic tide gate or gates incorporated in the dike. The dike is designed and constructed to prevent sea water from moving into the low areas and the tide gates are designed and installed to discharge the accumulated drainage water from the land side during periods of low tide. The success of such a system is dependent on the amount of storage available in the drainage channels, forebay area and connecting low areas on the land side of the dike. This storage area must be adequate to contain the interior drainage water accumulated during periods of high tide, and it must be below the elevation where damage to agricultural operations begins. If adequate storage is not available to meet the above requirements there are usually two alternatives. The storage area can be increased by excavating a larger drainage channel or forebay area, or pumps can be installed to remove a portion of the drain water so that the existing storage area will be adequate.

Topographic surveys

As pointed out in the previous discussion, the usual drainage plan for drainage of tidal lands involves a dike, tide gate structures and a land side

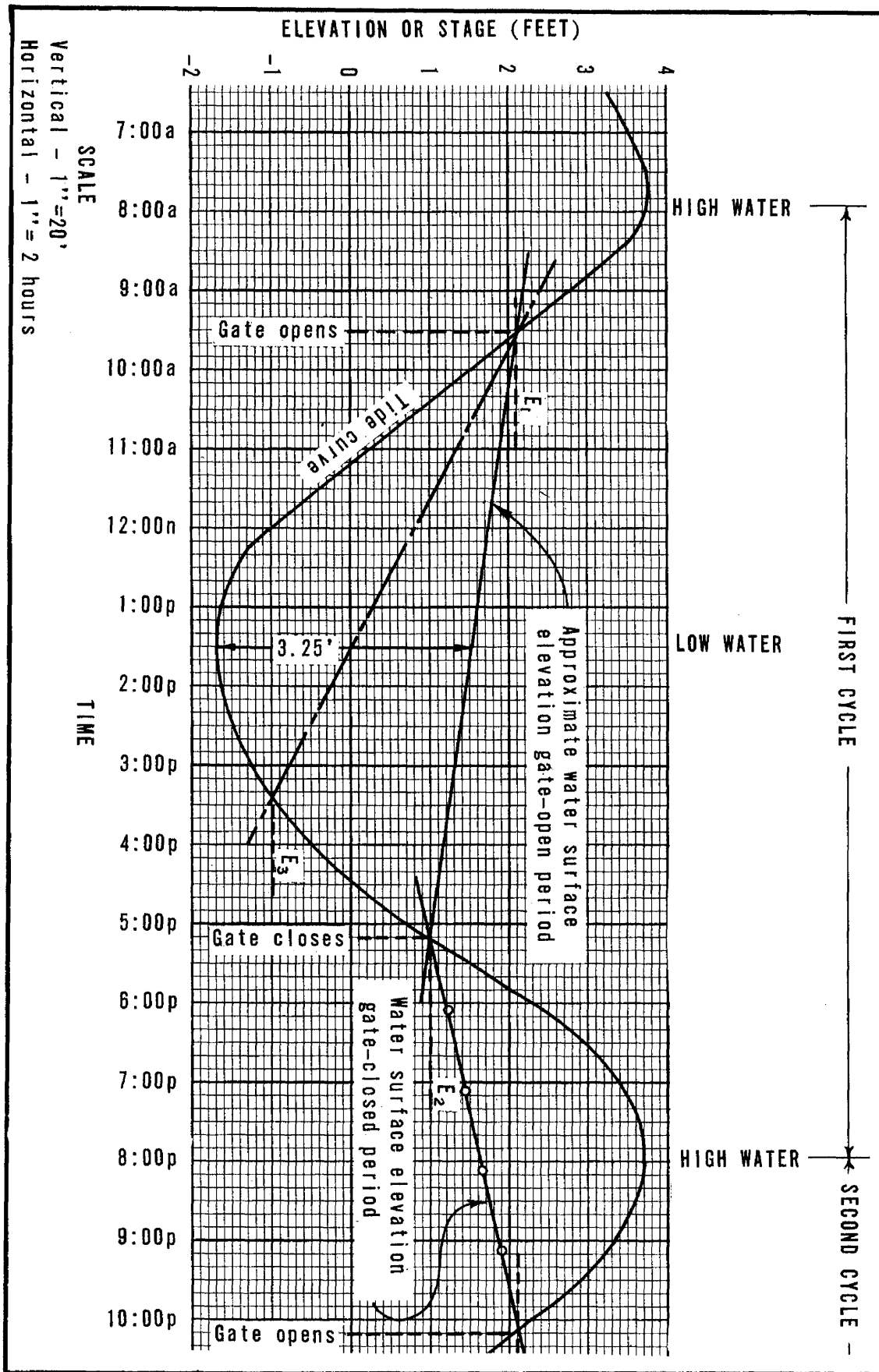

Figure 9-4, Tide curve

storage reservoir, which is the forebay area, the drainage channels and any other low areas connected with the drainage system. For design purposes it is necessary to relate the stage and volume of the storage area to the stage of the tide and to the elevation of the dike and tide gate or gates. For this reason it is necessary to have complete topography for the storage area and the site of the dike. Topographic surveys must be on the same datum as tidal observations. The topographic survey covering the storage area should be carried up to the high-water elevation at high tide or to some predetermined elevation which is the maximum permissible water level for agricultural operations.

Subsurface investigations

Dikes used in connection with the drainage of tidal lands are basically no different than dikes used for other purposes. Subsurface explorations are necessary to determine the foundation conditions and to locate suitable fill material. Dikes are classified as class I, II, or III, in accordance with the value of crops or property to be protected and the hazard to life. Refer to Table 6-1, Chapter 6, for a detailed classification of dikes. Dikes used in connection with the drainage of tidal lands usually contain tide gates and tide-gate structures. The dike and the gate structures are built as integral parts and are interdependent. If the dike should fail, there is a good chance that the gate structure would fail or be washed out also. For this reason, dikes containing gate structures are usually constructed to higher standards than dikes without gates.

Design Data

The basic information and data needed to design a drainage system for tidal lands includes the following:

1. A tide curve similar to the one shown as Figure 9-4, or one reconstructed from typical curves shown on Figure 9-3. The curve should cover one full cycle, from high water to high water, as indicated on Figure 9-4. This cycle will be referred to as the "first cycle" in this text. In addition, the curve should be continued into the "second cycle" for a period of about three hours, see Figure 9-4.
2. A stage-storage curve for the reservoir area, similar to the one shown on Figure 9-5. The vertical scale for stage or elevation must be on the same datum as the tide curve and the horizontal scale for storage should be in acre feet. The reservoir area includes the forebay, drainage channels, and any other connecting low areas that would be a part of the storage reservoir. The stage-storage curve should extend to high-water elevation at high tide, or to a previously established maximum water surface elevation in the forebay.
3. The maximum permissible water surface elevation in the forebay and reservoir area. This elevation is usually fixed by the intended land use and agronomic consideration of the crops to be grown on the land adjacent to the reservoir area. This establishes the highest level for storage of water in the forebay and also establishes the design heads through culverts and gates. As a general rule this elevation is established at about one foot below the general ground level. It is desirable to set this elevation as high as possible to obtain maximum storage.

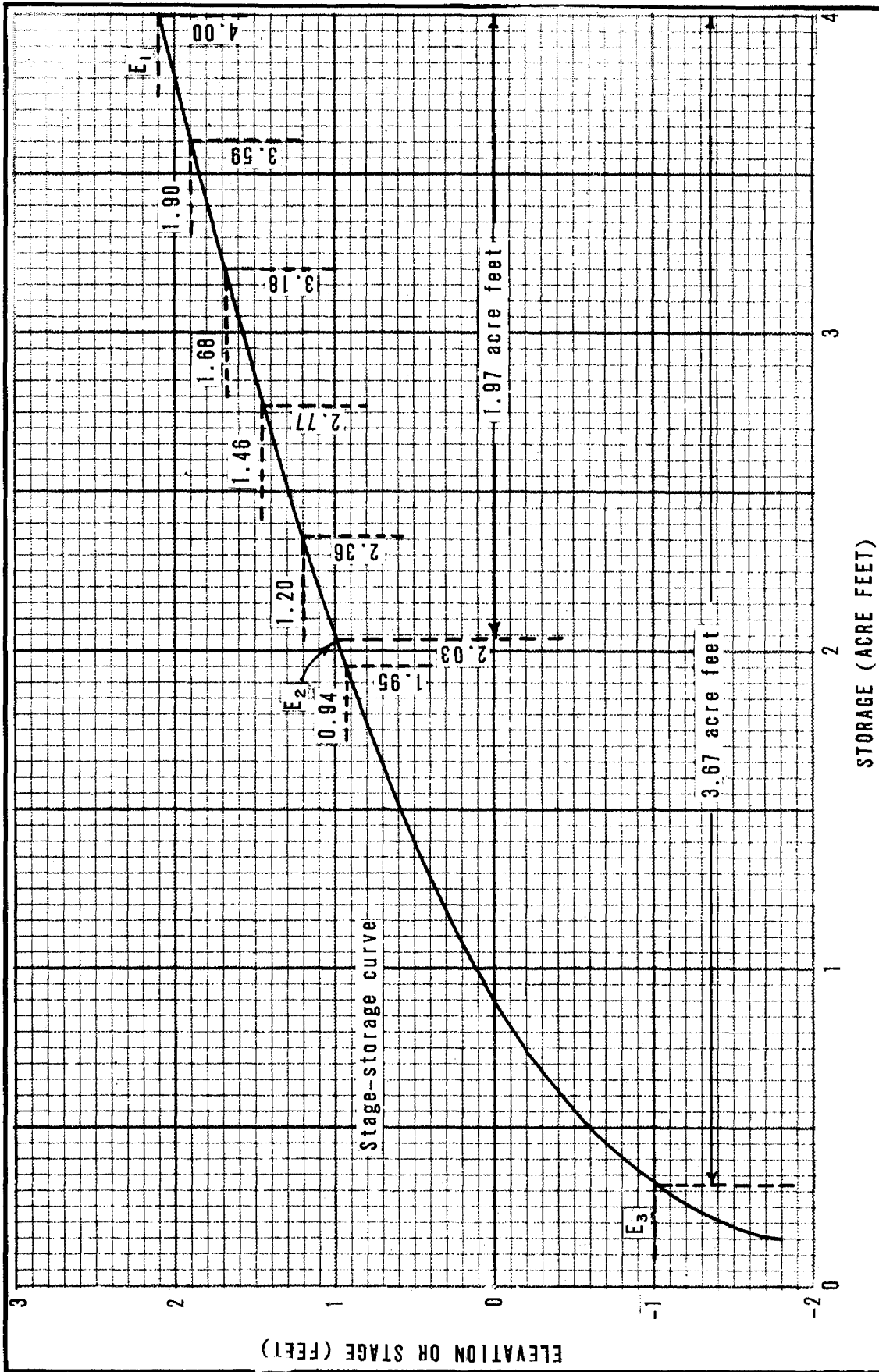

Figure 9-5, Stage-storage curve

4. The rate of drainage flow to the reservoir area. The design of the outlet system should be based on the same drainage coefficients, surface and/or subsurface, as are applicable to the adjoining non-tidal lands. Such coefficients are prescribed by local drainage guides. Usually the design for storm intensities of two year frequency is adequate for hay and pasture land, five year for rotated crops and ten to twenty year for intensive truck crops. If subsurface drains discharge into the outlet system the design flow should be increased by the amount of their accretion to the total flow.

Design Procedure and Example

The following design procedure for a tide-gate installation is a simplified graphical solution, based on the use of a tide curve and a stage-storage curve prepared for the site. The example is for a site subject to semi-diurnal tides; however, the same general procedure is applicable to diurnal tides. In view of the fact that this is a graphical method using a tide curve and a stage-storage curve prepared for the site, these curves should be prepared as accurately as possible and on a scale suitable for interpolation, consistent with the accuracy of the data plotted. The example given herein is necessarily based on the use of small scale charts suitable for inclusion in this handbook. In actual practice these charts should be drawn on a much larger scale to permit more accurate interpolation.

The following step by step explanation of this procedure, with example, is based on the assumption that a tide curve, Figure 9-4, and a stage-storage curve, Figure 9-5, have been prepared; that the drainage inflow to the system has been determined; and that the maximum water surface elevation for the fore-bay and reservoir area has been established. For the following example it will be assumed that the drainage inflow rate is 5.0 cfs and that the maximum permissible water surface elevation for the reservoir area is elevation + 2.10 feet.

Step 1. Plot the maximum water surface elevation + 2.10 feet on the ebb tide limbs for both cycles of the tide curve, Figure 9-4, and on the stage-storage curve, Figure 9-5. These points are noted as point E_1 on Figures 9-4 and 9-5, and are the pre-established elevation at which the tide gate will open.

Step 2. Compute the hourly volume of inflow to the storage reservoir. If the drainage inflow rate to the reservoir is 5.0 cfs, this is equivalent to a volume of 0.41 acre feet per hour. One cubic foot per second is one acre foot per 12.1 hours; therefore:

$$\text{Volume inflow per hour} = \frac{(5.0 \text{ cfs})(1.0 \text{ hour})}{12.1} = 0.41 \text{ acre feet hour}$$

Step 3. Compute the hourly volume of water in storage and the corresponding reservoir stage during the gate-closed period. Note that point E_1 in the second cycle of the tide curve is at elevation + 2.10 at 10:07 p.m. and the tide gate is just ready to open as the stage of the tide and the reservoir are the same. Referring to point E_1 on the stage-storage curve it will be noted that the storage reservoir contains 4.00 acre feet at this time. Prior to 10:07 p.m. the tide gate has been closed for several hours and the reservoir has been filling at the rate of 0.41 acre feet per hour. At 9:07 p.m. the reservoir contained $4.00 - 0.41 = 3.59$ acre feet; at 8:07 p.m. it contained $3.59 - 0.41 = 3.18$ acre feet etc. The water surface elevation or stage of the reservoir for any given volume of storage can be determined from the stage-storage curve. The following tabulation gives the volume of water in storage and the corresponding stage at hourly intervals during the period that the tide gate was closed:

| Time | Acre feet in storage | Stage of storage reservoir |
|------------|-------------------------|-------------------------------|
| 10:07 p.m. | 4.00 | + 2.10 |
| 9:07 p.m. | 3.59 | + 1.90 |
| 8:07 p.m. | 3.18 | + 1.68 |
| 7:07 p.m. | 2.77 | + 1.46 |
| 6:07 p.m. | 2.36 | + 1.20 |
| 5:07 p.m. | 1.95 | + 0.94 |

Step 4. Using the data in the above tabulation, plot the time-stage curve for the period 5:07 p.m. to 10:07 p.m. on the tide curve, Figure 9-4. Locate point E₂, the point where the tide curve and the time-stage curve intersect on the flood tide limb of the first cycle. This is the point where the tide gate will close as the stage of the tide and the storage reservoir are the same. Note that gate-closure occurs at 5:10 p.m. and the gate-closed time is 4 hours 57 minutes or 4.95 hours. The total drainage inflow during the gate-closed time is:

$$\text{Volume inflow} = \frac{(5.0 \text{ cfs})(4.95 \text{ hours})}{12.1} = 2.04 \text{ acre feet}$$

The stage at point E₂ on the tide curve is + 1.0 feet. Referring to the stage-storage curve the storage at a stage of + 1.0 is 2.03 acre feet and this subtracted from + 4.00, the storage of the full reservoir, is 1.97 acre feet. This indicates an error of 0.07 acre feet in the graphical solution which is well within the allowable limit of error.

Through the procedure described above, reservoir storage and inflow during the gate-closed period are now in balance and the time of gate-closure has been determined as 5:10 p.m. In this example the time-stage curve for the period 5:07 to 10:07 is virtually a straight line; however, it may be a flat curve in some cases, depending on the shape and configuration of the reservoir area.

Tide gate capacity and size

The previous discussion presented a method to determine the tide elevation at which the tide gate should open and close in order to balance the available forebay and reservoir storage against the drainage inflow during the time that the tide gate is closed. It is desirable to have the gate-closure elevation as high as possible in order to maintain a maximum head on the tide gate during the time that it is open and flowing.

The following discussion presents a method for determining the design capacity and size of a tide gate or gates. The example given is a continuation of the previous example used.

Step 1. Draw a straight line between points E₂ and E₁ in the first cycle of the tide curve, Figure 9-4. This is the approximate water surface elevation in the forebay during the time that the tide gate is open. The head on the tide gate (submerged flow) at any time is the vertical scaled distance between the tide elevation and the line drawn between E₁ and E₂ discussed above. For example, the head acting on the gate at 1:30 p.m. is 3.25 feet.

Step 2. Compute the volume of water to be discharged through the tide gate during the time that it is open from 9:30 a.m. to 5:10 p.m. This is the total volume of drainage inflow during one twelve hour cycle.

$$\text{Gate discharge one cycle} = \frac{(\text{inflow rate})(\text{time flow})}{12.1}$$

$$\text{Gate discharge one cycle} = \frac{(5.0 \text{ cfs})(12 \text{ hours})}{12.1} = 5.0 \text{ acre feet}$$

Step 3. Compute the average flow through the tide gate during the time that it is open. The tide gate is open from 9:30 a.m. to 5:10 p.m., or for a period of 7 hours and 40 minutes or 7.7 hours.

$$\text{Average flow} = \frac{(\text{inflow rate})(\text{cycle time})}{(\text{open-gate time})}$$

$$\text{Average flow} = \frac{(5.0 \text{ cfs})(12 \text{ hours})}{(7.7 \text{ hours})} = 7.8 \text{ cfs}$$

Step 4. Determine the average head on the tide gate during the time that the gate is open. The head at any time is equal to the vertical scaled distance between the tide curve and the straight line drawn between E_1 and E_2 , as explained in step 1. Determine the average head by scaling the head at 30 minute intervals; record this information in column 2, Table 9-2; and compute the average head for the gate-open period.

$$\text{Average head} = \frac{31.51}{15} = 2.10 \text{ feet}$$

Step 5. Make a trial computation for the gate size, using the average flow of 7.8 cfs computed in step 3; and the average head of 2.10 feet computed in step 4. Computing the discharge through a tide gate attached to pipes of various lengths is a rather complex problem. To simplify this for the designer, charts shown as Figures 9-6 and 9-6a have been prepared from computer solutions. The family of curves shown on these charts covers the range of tide gates from 12 inch to 66 inch, and for each size gate there are four pipe lengths of 100, 80, 60, 40 and 20 feet. This coverage is thought to be adequate for most situations. The head in feet is shown on the vertical scale and the discharge in cfs is shown on the horizontal scale. Note that the two charts, Figures 9-6 and 9-6a, are actually the same chart with alternate gate sizes shown on each to separate the curves and avoid the clutter and confusion of closely spaced curves. Using these charts and assuming a pipe length of 80 feet for this example, find the intersection of the average head 2.10 feet and the average discharge of 7.8 feet on Figure 9-6. This point falls between the 18" x 80' and the 18" x 100' curves. The 18" x 80' gate and pipe assembly has a discharge capacity of 8.0 cfs which is a little more than the average of 7.8 cfs and indicates that the 18 inch gate may be adequate. The above approximation, using average head and average discharge is only approximate and it is now necessary to refine these computations to determine if the 18 inch gate is adequate.

Step 6. Compute the average heads for each 30 minute increment of time that the tide gate is open, record these average heads in column 3, Table 9-2. Using Figure 9-6, determine the average discharge for each average head shown in column 3, and record these in column 4, Table 9-2. Compute the volume of discharge, in acre feet, for each 30 minute increment of time and record this in column 5, Table 9-2. Total column 5, to determine the total discharge of the tide gate during one tide cycle. This is equal to 4.82 acre feet which indicates that the 18" x 80' gate and pipe structure is adequate as the total drainage inflow, determined in step 2, was 5.0 acre feet. The difference between 4.82 and 5.00 is less than four percent which is within the allowable error for this determination. In the event that the discharge of the 18 inch

Table 9-2, Tide gate data sheet

| (1) | (2) | (3) | (4) | (5) |
|------------------|-------------------------|--|---|--|
| Time | Measured Head (feet) | Average Head 30 min. int. (feet) | Average <u>1</u> / Discharge 18" X 80' (cfs) | Volume <u>2</u> / Discharge 18" X 80' (acre feet) |
| Gate open 9:30a | 0.00 | | | |
| 10:00a | 0.50 | 0.25 | 2.43 | 0.10 |
| 10:30a | 1.10 | 0.80 | 4.80 | 0.20 |
| 11:00a | 1.65 | 1.37 | 6.42 | 0.27 |
| 11:30a | 2.20 | 1.92 | 7.70 | 0.32 |
| 12:00n | 2.75 | 2.47 | 8.70 | 0.36 |
| 12:30p | 3.15 | 2.95 | 9.60 | 0.40 |
| 1:00p | 3.28 | 3.21 | 10.03 | 0.42 |
| 1:30p | 3.25 | 3.26 | 10.04 | 0.42 |
| 2:00p | 3.10 | 3.17 | 9.90 | 0.41 |
| 2:30p | 2.90 | 3.00 | 9.70 | 0.40 |
| 3:00p | 2.60 | 2.75 | 9.25 | 0.39 |
| 3:30p | 2.15 | 2.37 | 8.60 | 0.36 |
| 4:00p | 1.63 | 1.89 | 7.60 | 0.32 |
| 4:30p | 1.00 | 1.31 | 6.30 | 0.26 |
| 5:00p | 0.25 | 0.62 | 4.15 | 0.17 |
| Gate close 5:10p | 0.00 | 0.13 | 1.65 | 0.02 <u>3</u> / |
| Totals | 31.51 | ---- | ---- | 4.82 |

1/ Average discharge for 18" tide gate attached to 80' pipe.

2/ Volume of discharge for 18" tide gate attached to 80' pipe.

3/ Adjusted for 10 minute time interval.

DRAINAGE: HEAD vs DISCHARGE - FLAPGATE WITH ATTACHED LENGTHS OF CORRUGATED METAL PIPE

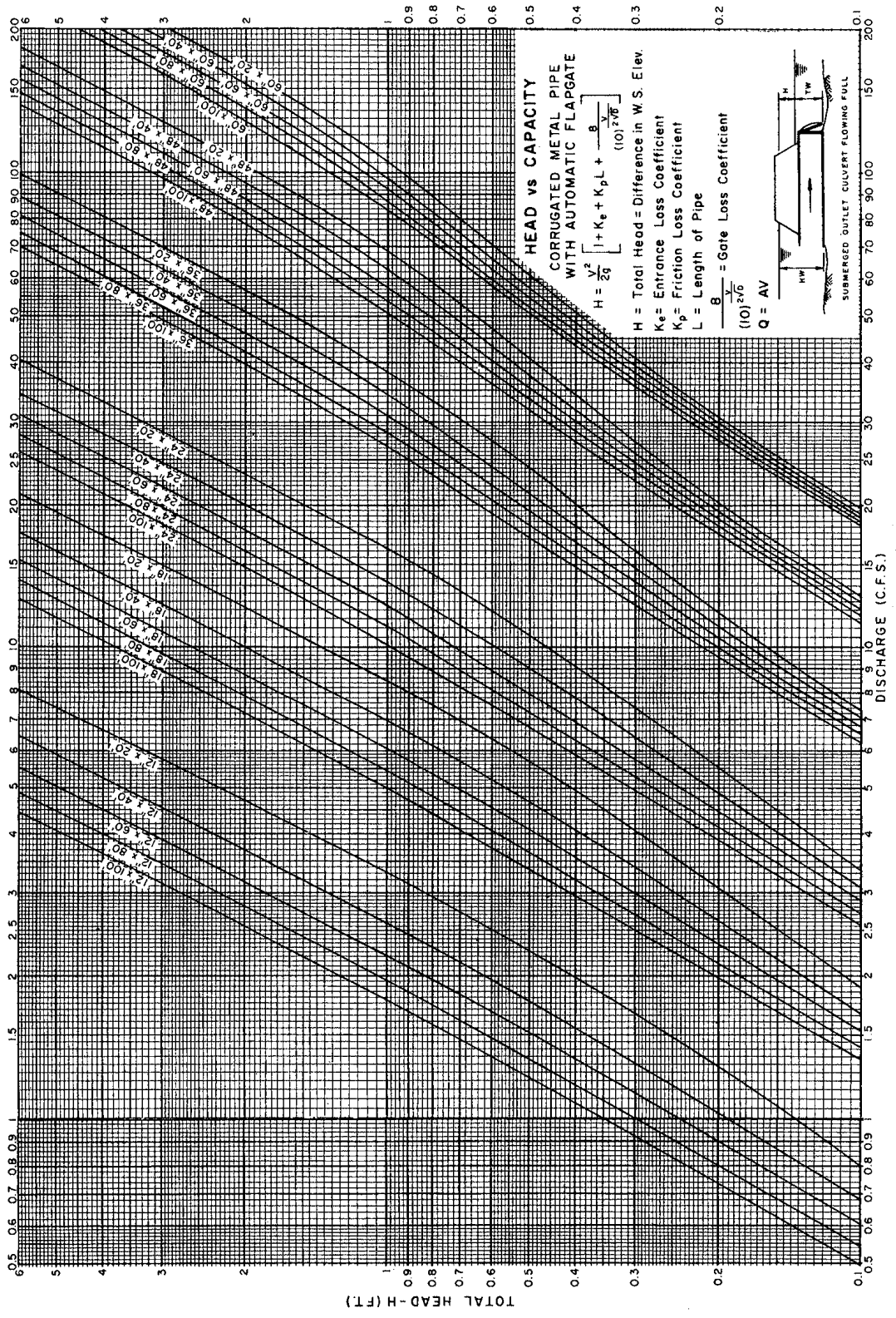

DRAINAGE: HEAD vs DISCHARGE - FLAPGATE WITH ATTACHED LENGTHS OF CORRUGATED METAL PIPE

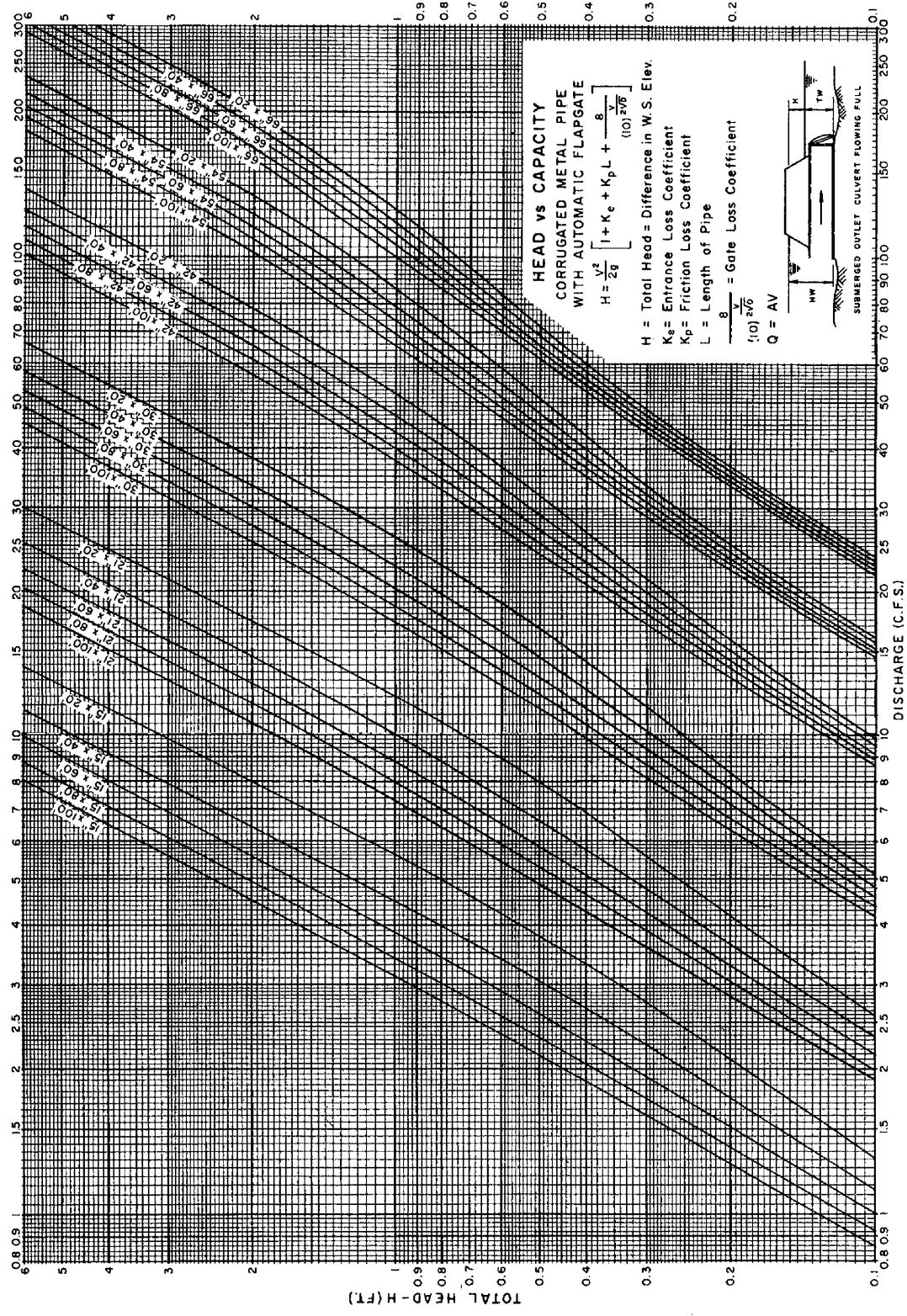

DRAINAGE: HEAD vs DISCHARGE - FLAPGATE WITH ATTACHED LENGTHS OF CORRUGATED METAL PIPE

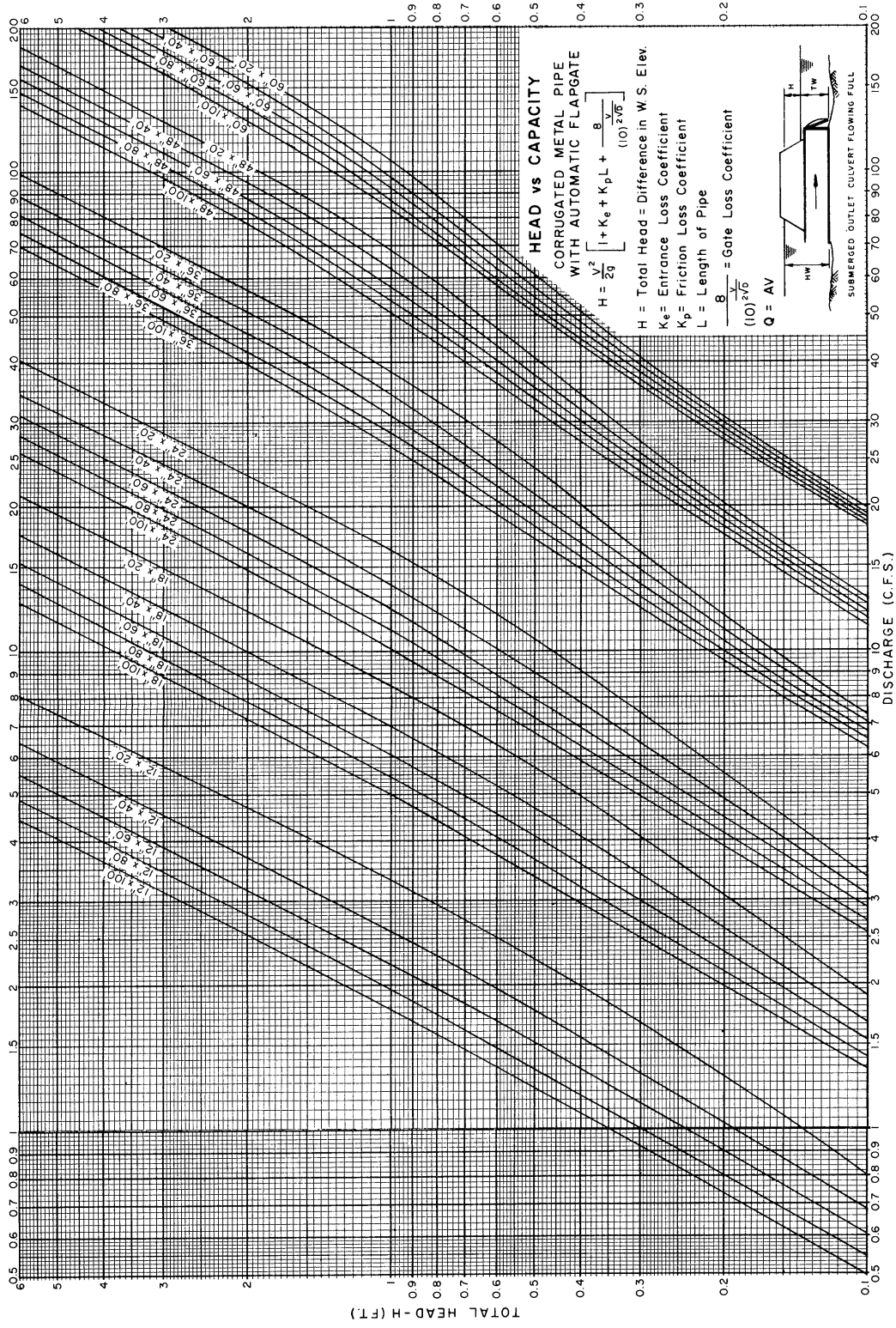

REFERENCE

These curves were developed by the Design Section, EWPU Portland

U.S. DEPARTMENT OF AGRICULTURE
SOIL CONSERVATION SERVICE

STANDARD NO.
ES-723

SHEET 1 OF 2
DATE 10-15-70

ENGINEERING DIVISION - DRAINAGE SECTION

Figure 9-6, Curves for tide gate discharge
ES-723

DRAINAGE: HEAD vs DISCHARGE - FLAPGATE WITH ATTACHED LENGTHS OF CORRUGATED METAL PIPE

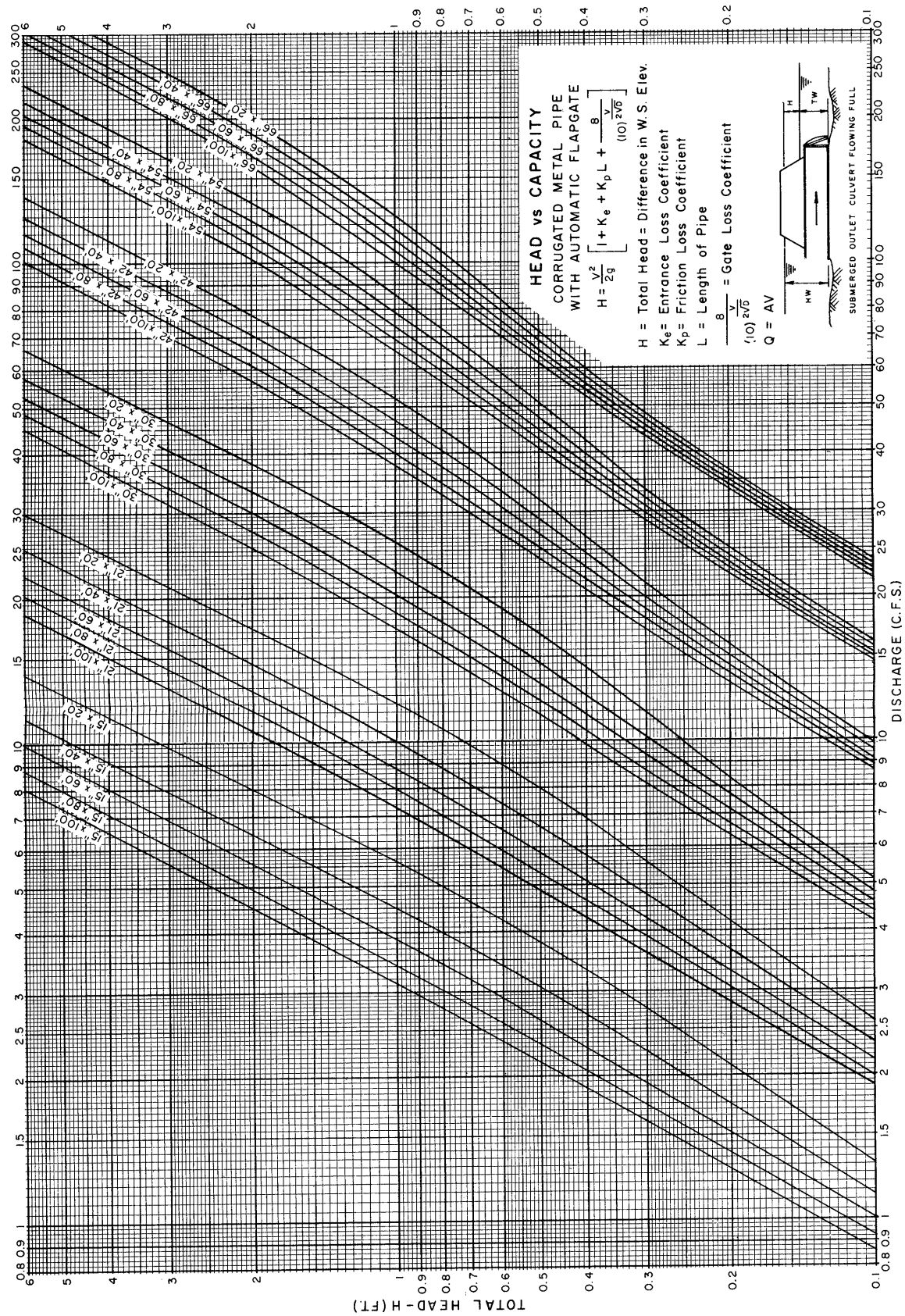

REFERENCE

These curves were developed by the Design Section, EWPU Portland

U.S. DEPARTMENT OF AGRICULTURE
SOIL CONSERVATION SERVICE
 ENGINEERING DIVISION - DRAINAGE SECTION

STANDARD DING. NO.
ES-723
 SHEET 2 OF 2
 DATE 10-15-70



Figure 9-6a, Curves for tide gate discharge
ES-723

tide gate was considerably less than the drainage inflow for the cycle, the next larger size gate, a 21 inch gate would be selected and it would be necessary to repeat step 6, to compute the discharge of this gate.

Figures 9-7, 9-7a, and 9-7b, showing the sequence of relative stage elevations, of ocean and forebay, versus time, have been included to help the reader to visualize the operation of a tide gate installation. These have been prepared to illustrate the previous problem, assuming an 18 inch tide gate installation and using the data tabulated in Table 9-2.

Supplemental Pumping

The previous example for the design of a tide gate installation was based on a situation where there was more than adequate reservoir area to store the accumulated drainage inflow during the period that the tide gate was closed. In actual practice this is not always the case, as there may not be adequate storage area in the forebay and natural or artificial channels on the land side of the dike and tide gate. Where the storage is not adequate, there are two alternatives open to the designer. The storage area can be increased by excavating a larger forebay and channel area or pumps can be installed to remove a part of the drainage inflow to balance the available storage to the drainage inflow for the time that the tide gate was closed. In the previous example the storage reservoir was lowered to elevation + 1.0 feet which was all that was necessary to provide the required 1.97 acre feet of storage needed while the tide gate was closed. This was only about one half of the total storage area available in this reservoir.

As a general rule, it is usually not practical to attempt to lower the water surface in the forebay and reservoir lower than elevation - 1.0 feet because of the construction problems involved with sloughing and in de-watering the site; however, this will depend on individual site conditions. Referring to the previous example, if the reservoir had been lowered to elevation - 1.0 feet it would have been possible to store 3.67 acre feet rather than 1.97 acre feet and the gate-closed time would have been 6 hours and 42 minutes rather than 4 hours and 57 minutes. This would be the maximum utilization of this storage reservoir, assuming that it could be lowered to elevation - 1.0 feet, and would provide for a drainage inflow rate of about 6.6 cfs. If the drainage inflow was greater than 6.6 cfs it would be necessary to resort to supplemental pumping to remove a portion of the drainage inflow during the time that the tide gate was closed.

The above discussion suggests a rapid method to estimate the capability of a given reservoir or storage area for a known drainage inflow rate. The procedure is as follows:

Step 1. Based on a consideration of site conditions and the intended use of the land being protected, establish the maximum and minimum stages for the reservoir. These stages will establish the gate-open and gate-closure times on the tide curve and the gate-closed time can be computed.

Step 2. The available storage between maximum and minimum reservoir stage can be determined by plotting these stages on the stage-storage curve and determining the storage between these points.

Step 3. Having determined the gate-open time and the available reservoir storage and knowing the inflow rate, the required storage can be computed and compared to the available storage. If the required storage is equal to or less than the available, the reservoir is adequate and pumping will not be

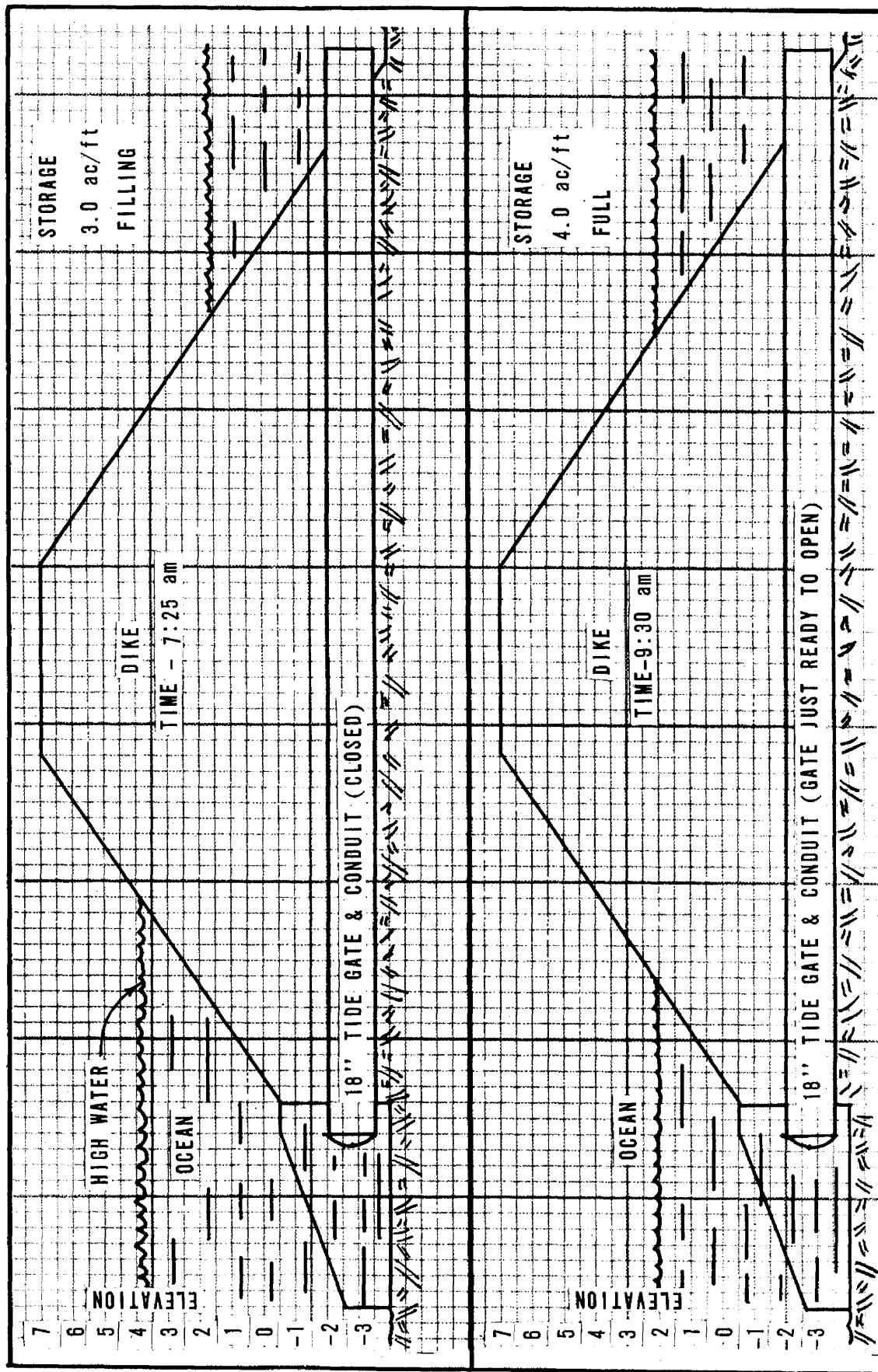

Figure 9-7, Sketches of dike and gate structure showing the stage sequence versus time

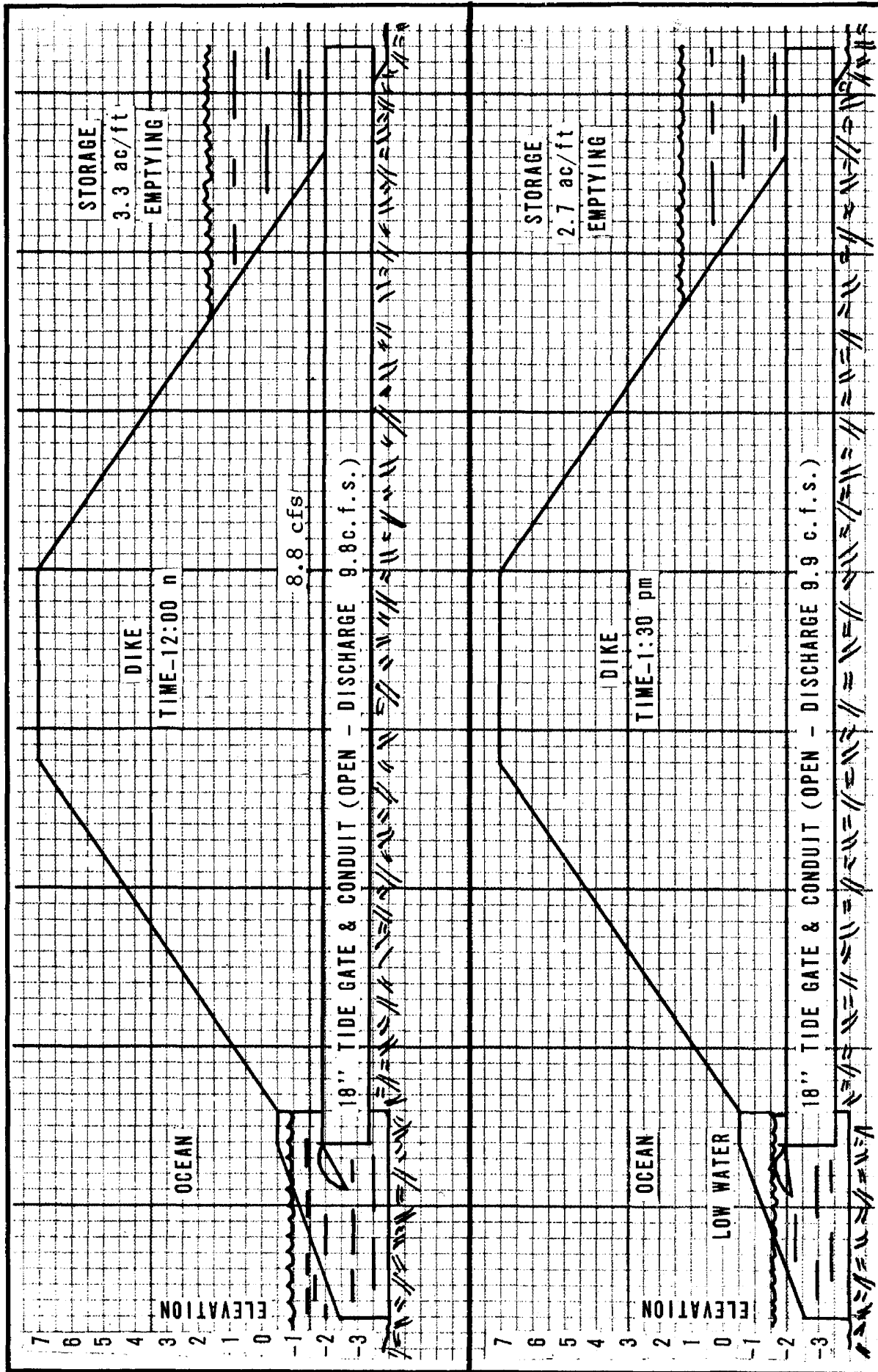

Figure 9-7a, Sketches of dike and gate structure showing the stage sequence versus time

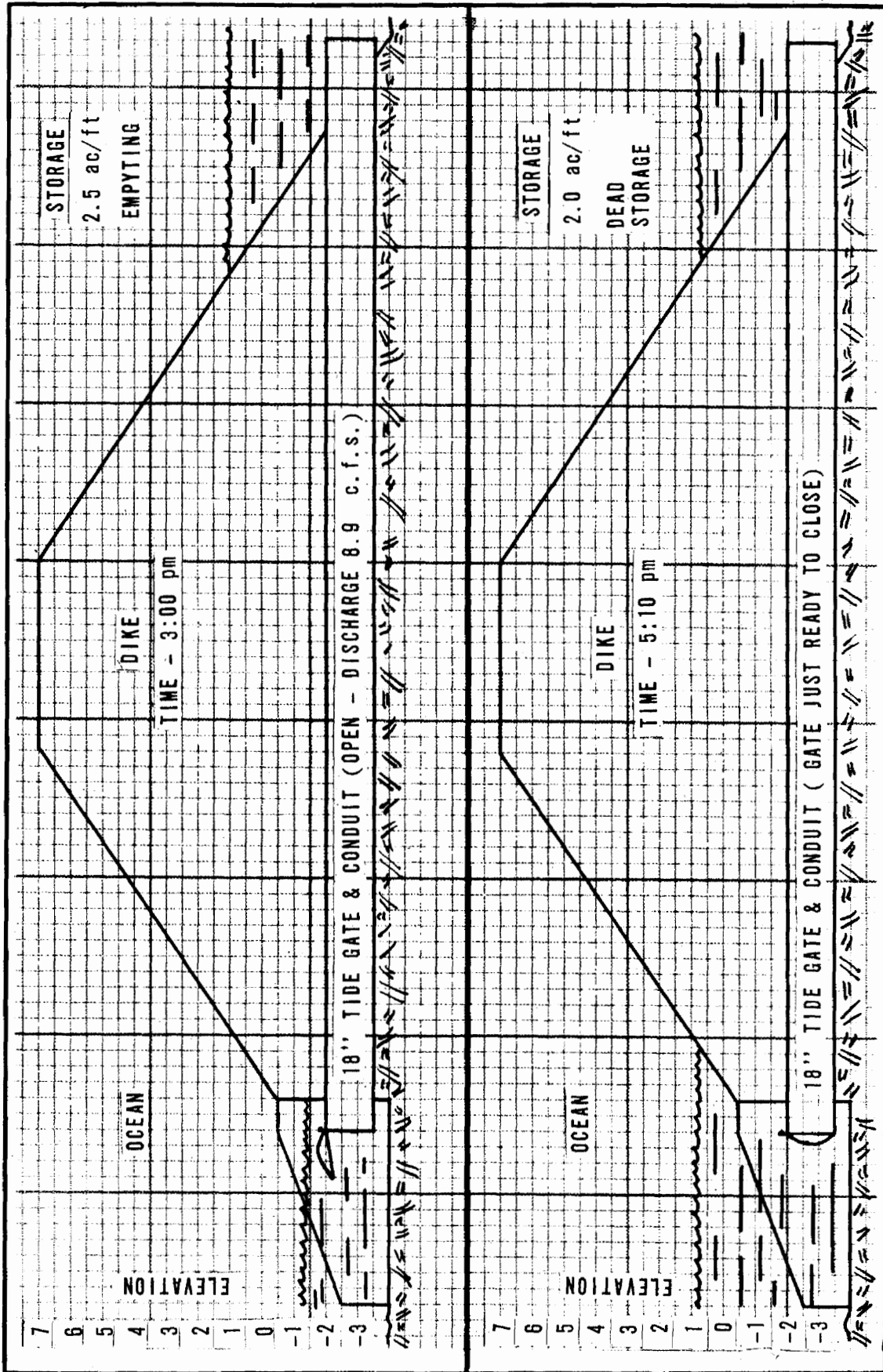

Figure 9-7b - Sketches of dike and gate structure showing the stage sequence versus time

required. If the required storage is greater than the available storage the reservoir might be enlarged or a part of the drainage inflow might be pumped.

This simple determination, to establish whether or not pumping will be required, may determine the feasibility of the project without proceeding further to calculate the tide gate capacity and size.

Pumping requirement

In the previous example it was determined that the storage reservoir had a usable capacity of 3.67 acre feet with drawdown to elevation - 1.0 feet. It was also determined that the capability of the reservoir was limited to a drainage inflow rate of about 6.6 cfs without supplemental pumping or enlargement of the reservoir. In the following example it will be assumed that the inflow rate is 9.0 cfs; that the reservoir can be drawn down to elevation - 1.0 feet, noted as point E₃ on Figure 9-4, and that all other conditions will remain the same as in the previous example.

Step 1. Determine the gate-closed time. The gate-closed time is the time difference between point E₃ and point E₁ on the ebb tide limb of the second cycle of the tide curve. The gate will close at 3:25 p.m. and open at 10:07 p.m.; therefore, the gate-closed time is 6 hours and 42 minutes or 6.70 hours.

Step 2. Determine the volume of accumulated drainage inflow that collects during the gate-closed period.

$$\text{Inflow volume} = \frac{(9.0 \text{ cfs})(6.7 \text{ hours})}{12.1} = 4.98 \text{ acre feet}$$

Step 3. Determine the storage available above elevation - 1.0 feet. Plot point E₃ on the stage-storage curve, Figure 9-5, and determine the volume of storage between points E₁ and E₃. This is equal to 3.67 acre feet.

Step 4. Determine the required pumping rate. If the required storage is 4.98 acre feet and the available storage is 3.67 acre feet this leaves a deficit of 1.31 acre feet which must be pumped during the gate closed period.

$$\text{Pumping rate - cfs} = \frac{(12.1)(1.31)}{6.70} = 2.37 \text{ cfs or } 1064 \text{ gpm}$$

A pump that will handle 1000 gpm would probably be adequate.

Lowering the reservoir to elevation - 1.0 feet will materially reduce the head on the tide gate during the time that it is open and will also shorten the time that the tide gate is open. Referring to the tide curve Figure 9-4, the straight line drawn between points E₁ in the first cycle and E₃ will be the approximate water surface elevation during the gate-open period and it will be necessary to recompute the capacity and size of tide gate required. From inspection it is obvious that this situation will require a much larger tide gate than the one in the first example.

Step 1. Compute the volume of water to be discharged through the tide gate during the time that it is open, from 9:30 a.m. to 3:25 p.m. which is 5.92 hours. This is the total volume of drainage inflow during one twelve hour cycle less the volume of water pumped during the gate-closed period. This is equal to 9.00 - 1.31 = 7.69 acre feet.

Step 2. Compute the average flow through the tide gate during the time that it is open.

$$\text{Average flow} = \frac{(7.69 \text{ cfs})(12 \text{ hours})}{5.92 \text{ hours}} = 15.59 \text{ cfs}$$

Step 3. Determine the average head on the tide gate during the time that the gate is open, and record this information in column 2, Table 9-3.

$$\text{Average head} = \frac{13.90}{12} = 1.16 \text{ feet}$$

Step 4. Make a trial computation for the gate size, using the average flow of 15.59 cfs as computed in step 2; and the average head of 1.16 as computed in step 3. Referring to the chart, Figure 9-6 it will be noted that the 24" x 80' gate and pipe assembly has a capacity of about 12.0 cfs and the next larger size, a 30" x 80' has a capacity of about 20.0 cfs; therefore, it is assumed that 30" gate assembly will be required. This trial computation is only approximate as the average head and the average discharge were used. It is necessary to refine these computations to determine if this gate and assembly will discharge the required 7.69 acre feet.

Step 5. Compute the average heads for each 30 minute increment or time that the tide gate is open, record these average heads in column 3, Table 9-3 and complete the table. The total discharge is 9.59 acre feet which is in excess of the requirement.

In this example it was assumed that the 1000 gpm pump would operate only during the gate-closed period, to reduce the demand on the available storage reservoir. This is the usual system employed for most tidal drainage projects. If the pump was set to operate on a continuous basis it will further reduce the volume of water that must pass through the tide gate, thereby permitting use of a tide gate with less capacity. This would reduce the cost of the tide gate installation and would increase the cost of pumping. This is seldom done as the cost of continuous pumping, over a long period of time, is usually much more than the increased initial cost for a larger tide gate installation.

Construction and Installation

Forebay channel section

The forebay channel section must have adequate capacity to deliver the design drainage discharge to the forebay and tide gate and it must also have capacity to pass the peak discharge of the tide gate. The peak discharge may be several times the drainage inflow. In case of the previous example, see column 5, Table 9-2, the peak discharge was about 10.0 cfs at 1:00 p.m., or twice the drainage inflow.

Discharge bay channel section

The discharge section of the outlet bay should be designed with ample capacity to discharge the peak flow to deep open water without causing backwater against the tide gate. Usually low foreshore banks have adequate overflow area to accommodate such discharge, however, they should be checked to insure that they do.

Table 9-3, Tide gate data sheet

| (1) | (2) | (3) | (4) | (5) |
|------------------|-------------------------|--|---------------------------------------|--|
| Time | Measured Head (feet) | Average Head 30 min. int. (feet) | Average Discharge 30"X80' (cfs) | Volume Discharge 30"X80' (acre feet) |
| Gate open 9:30a | 0.00 | | | |
| 10:00a | 0.35 | 0.18 | 6.23 | 0.26 |
| 10:30a | 0.75 | 0.55 | 12.80 | 0.53 |
| 11:00a | 1.10 | 0.92 | 17.75 | 0.74 |
| 11:30a | 1.45 | 1.27 | 21.30 | 0.89 |
| 12:00n | 1.84 | 1.64 | 24.80 | 1.03 |
| 12:30p | 2.00 | 1.92 | 26.80 | 1.17 |
| 1:00p | 1.90 | 1.95 | 27.25 | 1.13 |
| 1:30p | 1.72 | 1.81 | 26.00 | 1.08 |
| 2:00p | 1.36 | 1.54 | 23.85 | 0.99 |
| 2:30p | 0.97 | 1.16 | 20.10 | 0.84 |
| 3:00p | 0.46 | 0.71 | 15.20 | 0.63 |
| Gate close 3:25p | 0.00 | 0.23 | 7.30 | 0.30 |
| Totals | 13.90 | ---- | ---- | 9.59 |

Tide gates, pipes and outlet structures

As a rule tide gate structures must be installed in wet, swampy areas and tidal flats where construction is difficult at best. The structure is usually placed at a minus elevation so that the gate functions as a submerged orifice, at all times. Structural sites and approach channels are usually excavated by dragline, which also serves as a crane for hoisting gates, pipes and other structural members in place. During construction the site is isolated from surface waters by encircling the site with spoil banks that act as temporary dikes and it may be necessary to dewater the excavation by pumping. Under very difficult conditions it may be necessary to shore the excavation with sheet piling, and encircle it with a battery of dewatering wells connected to a manifold and pump.

An outlet structure is usually necessary to protect the gate and connecting pipe from scour and floating debris. Treated timber structures, as illustrated in the standard design, Figure 9-8, have proven very practical and economical to install. This type structure can be prefabricated in whole or in part, depending upon the size, and set into place by dragline for attachment to preset piles that have been driven or jetted into the foundation. Cast in place concrete or masonry is not usually satisfactory for this kind of site unless the excavation can be kept free from salt water long enough for the cement to set.

Corrugated metal pipes are commonly used in tide gate structures and must be asbestos bonded to resist salt water corrosion. The pipes should be 10 gauge or thicker to insure long life under these severe saline conditions. Experience has shown that thin gauge noncoated pipes have a very short life in brackish water.

The pipe conduit and gate, unless of very small size, should be installed as separate units. Usually, a short or stub section of conduit is fabricated to the gate and joined to the pipe after both are placed. Camber should be provided in the excavated trench bed to allow for consolidation and unequal loading by the superimposed dike. Conduit and gate must be set true to line and grade if the structure is to operate as designed. Prefabricated cast iron flap gates, usually called tide gates when used for tidal installations, have bronze bushings and are coated with water-resistant rust preventative compound at the factory and have a long life even under brackish water. Figure 9-9, shows a typical flap gate suitable for tidal drainage. This type flap gate is also available with stainless steel hardware as a further precaution against salt water corrosion.

In those cases where tide gates must have a large capacity to discharge the drainage flow during the low tide period, it is usually desirable to install a battery of small gates rather than one or two large gates. As a general rule tide gates are placed so that the top of the gate is at about elevation - 1.0 feet, to provide for submergence at all times and to provide for full utilization of the available storage reservoir. These conditions dictate that the pipe and gate be placed entirely below zero elevation, which in turn imposes difficult construction conditions. From this it is obvious small diameter gates and pipe can be installed much more easily than large diameter structures. For example; five 24" gates in a battery will have about the same discharge as one 48" gate and reduce the depth of trench excavation by two feet. This two foot reduction in trench depth may materially simplify construction and more than pay for the additional cost of multiple gates.

Supplemental pump installations

Pumps and pumping installations are covered in Chapter 7, Drainage Pumping, of this handbook. Pump installations for pumping drainage water, in connection with tidal drainage, are usually low head, high capacity type installations. In most parts of the country, excluding Alaska and coastal areas of the northeast, the tidal range seldom exceeds eight feet, except during periods of severe storms. The average pumping lift is usually small, in the range of zero to four feet and pumps selected for this condition should have a high efficiency at low head operation. Propeller and mixed flow type pumps are best suited for this situation. See Chapter 7, for a detailed discussion of pumps and structures for pumping installations.

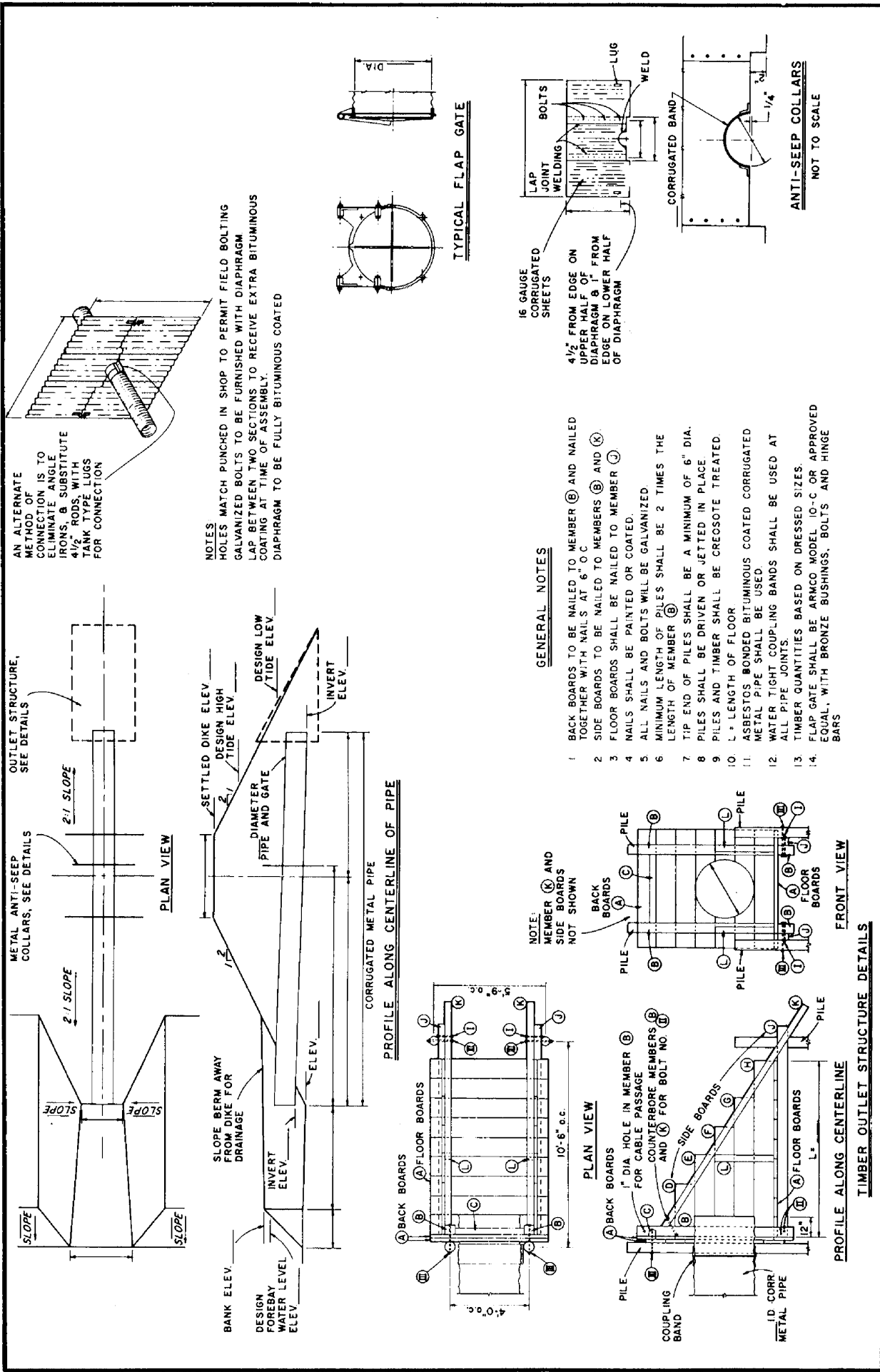

Figure 9-8, Drainage flap gate installation

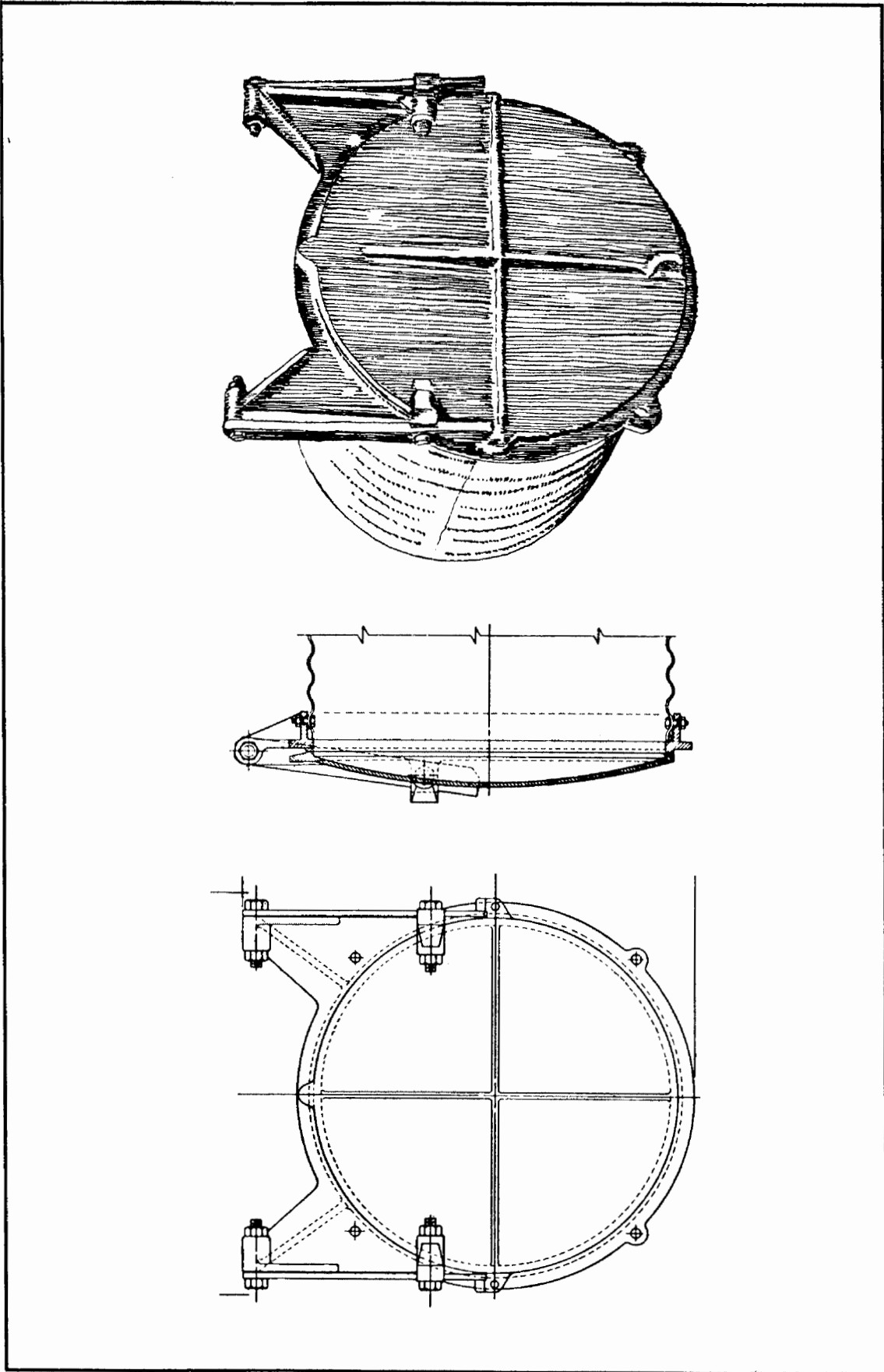

Figure 9-9, Typical low-head tide gate

As previously mentioned, pumps used in tidal drainage situations are usually operated only during the gate-closed period, to reduce the storage requirement. They can be operated during the gate-open period also; however, this is seldom done as the only benefit is to reduce the load on the tide gate permitting use of a smaller gate. Generally, the cost of pumping during this gate-open period, for the life of the project, is far in excess of the cost of a larger gate.

References

- (1) ENGINEERING DIVISION, SCS .
1955. Routing Through Tide Gates. Technical Release No. 1,
USDA, Soil Conservation Service, Engineering Division.
- (2) MARMER, H. A.
1951. Tidal Datum Planes. Special Publication No. 135,
U. S. Department of Commerce, Coast and Geodetic Survey.
- (3) PILLSBURY, GEORGE B.
1956. Tidal Hydraulics. USAE Waterways Experiment Station,
Vicksburg, Miss.

